

Oracle® Database

Database PL/SQL Language Reference



19c
E96448-05
March 2023

The Oracle logo, consisting of a solid red square with the word "ORACLE" in white, uppercase, sans-serif font centered within it.

ORACLE®

Oracle Database Database PL/SQL Language Reference, 19c

E96448-05

Copyright © 1996, 2023, Oracle and/or its affiliates.

Primary Author: Louise Morin

Contributing Authors: S. Moore, L. Jayapalan, P. Huey, E. Belden, K. Rich, V. Moore

Contributors: D. Alpern, S. Agrawal, H. Baer, S. Castledine, T. Chang, B. Cheng, R. Dani, R. Decker, C. Iyer, A. Kruglikov, N. Le, W. Li, B. Llewellyn, T. Raney, R. Rajagopalan, I. Stocks, C. Wetherell, S. Wolicki, G. Viswanathan, M. Yang

This software and related documentation are provided under a license agreement containing restrictions on use and disclosure and are protected by intellectual property laws. Except as expressly permitted in your license agreement or allowed by law, you may not use, copy, reproduce, translate, broadcast, modify, license, transmit, distribute, exhibit, perform, publish, or display any part, in any form, or by any means. Reverse engineering, disassembly, or decompilation of this software, unless required by law for interoperability, is prohibited.

The information contained herein is subject to change without notice and is not warranted to be error-free. If you find any errors, please report them to us in writing.

If this is software, software documentation, data (as defined in the Federal Acquisition Regulation), or related documentation that is delivered to the U.S. Government or anyone licensing it on behalf of the U.S. Government, then the following notice is applicable:

U.S. GOVERNMENT END USERS: Oracle programs (including any operating system, integrated software, any programs embedded, installed, or activated on delivered hardware, and modifications of such programs) and Oracle computer documentation or other Oracle data delivered to or accessed by U.S. Government end users are "commercial computer software," "commercial computer software documentation," or "limited rights data" pursuant to the applicable Federal Acquisition Regulation and agency-specific supplemental regulations. As such, the use, reproduction, duplication, release, display, disclosure, modification, preparation of derivative works, and/or adaptation of i) Oracle programs (including any operating system, integrated software, any programs embedded, installed, or activated on delivered hardware, and modifications of such programs), ii) Oracle computer documentation and/or iii) other Oracle data, is subject to the rights and limitations specified in the license contained in the applicable contract. The terms governing the U.S. Government's use of Oracle cloud services are defined by the applicable contract for such services. No other rights are granted to the U.S. Government.

This software or hardware is developed for general use in a variety of information management applications. It is not developed or intended for use in any inherently dangerous applications, including applications that may create a risk of personal injury. If you use this software or hardware in dangerous applications, then you shall be responsible to take all appropriate fail-safe, backup, redundancy, and other measures to ensure its safe use. Oracle Corporation and its affiliates disclaim any liability for any damages caused by use of this software or hardware in dangerous applications.

Oracle®, Java, and MySQL are registered trademarks of Oracle and/or its affiliates. Other names may be trademarks of their respective owners.

Intel and Intel Inside are trademarks or registered trademarks of Intel Corporation. All SPARC trademarks are used under license and are trademarks or registered trademarks of SPARC International, Inc. AMD, Epyc, and the AMD logo are trademarks or registered trademarks of Advanced Micro Devices. UNIX is a registered trademark of The Open Group.

This software or hardware and documentation may provide access to or information about content, products, and services from third parties. Oracle Corporation and its affiliates are not responsible for and expressly disclaim all warranties of any kind with respect to third-party content, products, and services unless otherwise set forth in an applicable agreement between you and Oracle. Oracle Corporation and its affiliates will not be responsible for any loss, costs, or damages incurred due to your access to or use of third-party content, products, or services, except as set forth in an applicable agreement between you and Oracle.

Contents

Preface

Audience	xxxiv
Documentation Accessibility	xxxiv
Related Documents	xxxv
Conventions	xxxv
Syntax Descriptions	xxxvi

Changes in This Release for Oracle Database PL/SQL Language Reference

Changes in Oracle Database Release 19c	xxxvii
Changes in Oracle Database Release 18c	xxxviii
Deprecated Features	xxxix
Desupported Features	xxxix

1 Overview of PL/SQL

1.1 Advantages of PL/SQL	1-1
1.1.1 Tight Integration with SQL	1-1
1.1.2 High Performance	1-2
1.1.3 High Productivity	1-2
1.1.4 Portability	1-2
1.1.5 Scalability	1-3
1.1.6 Manageability	1-3
1.1.7 Support for Object-Oriented Programming	1-3
1.2 Main Features of PL/SQL	1-3
1.2.1 Error Handling	1-4
1.2.2 Blocks	1-4
1.2.3 Variables and Constants	1-5
1.2.4 Subprograms	1-5
1.2.5 Packages	1-5
1.2.6 Triggers	1-5
1.2.7 Input and Output	1-6

1.2.8	Data Abstraction	1-7
1.2.8.1	Cursors	1-7
1.2.8.2	Composite Variables	1-7
1.2.8.3	Using the %ROWTYPE Attribute	1-8
1.2.8.4	Using the %TYPE Attribute	1-8
1.2.8.5	Abstract Data Types	1-8
1.2.9	Control Statements	1-9
1.2.10	Conditional Compilation	1-9
1.2.11	Processing a Query Result Set One Row at a Time	1-9
1.3	Architecture of PL/SQL	1-10
1.3.1	PL/SQL Engine	1-10
1.3.2	PL/SQL Units and Compilation Parameters	1-11
1.4	Protecting Sensitive Information in PL/SQL	1-13

2 PL/SQL Language Fundamentals

2.1	Character Sets	2-1
2.1.1	Database Character Set	2-1
2.1.2	National Character Set	2-3
2.1.3	About Data-Bound Collation	2-3
2.2	Lexical Units	2-4
2.2.1	Delimiters	2-4
2.2.2	Identifiers	2-6
2.2.2.1	Reserved Words and Keywords	2-6
2.2.2.2	Predefined Identifiers	2-6
2.2.2.3	User-Defined Identifiers	2-7
2.2.3	Literals	2-10
2.2.4	Pragmas	2-12
2.2.5	Comments	2-13
2.2.5.1	Single-Line Comments	2-13
2.2.5.2	Multiline Comments	2-14
2.2.6	Whitespace Characters Between Lexical Units	2-15
2.3	Declarations	2-15
2.3.1	NOT NULL Constraint	2-15
2.3.2	Declaring Variables	2-16
2.3.3	Declaring Constants	2-17
2.3.4	Initial Values of Variables and Constants	2-17
2.3.5	Declaring Items using the %TYPE Attribute	2-19
2.4	References to Identifiers	2-20
2.5	Scope and Visibility of Identifiers	2-21
2.6	Assigning Values to Variables	2-25

2.6.1	Assigning Values to Variables with the Assignment Statement	2-26
2.6.2	Assigning Values to Variables with the SELECT INTO Statement	2-26
2.6.3	Assigning Values to Variables as Parameters of a Subprogram	2-27
2.6.4	Assigning Values to BOOLEAN Variables	2-28
2.7	Expressions	2-28
2.7.1	Concatenation Operator	2-29
2.7.2	Operator Precedence	2-30
2.7.3	Logical Operators	2-32
2.7.4	Short-Circuit Evaluation	2-37
2.7.5	Comparison Operators	2-37
2.7.5.1	IS [NOT] NULL Operator	2-38
2.7.5.2	Relational Operators	2-38
2.7.5.3	LIKE Operator	2-40
2.7.5.4	BETWEEN Operator	2-42
2.7.5.5	IN Operator	2-42
2.7.6	BOOLEAN Expressions	2-43
2.7.7	CASE Expressions	2-44
2.7.7.1	Simple CASE Expression	2-44
2.7.7.2	Searched CASE Expression	2-46
2.7.8	SQL Functions in PL/SQL Expressions	2-47
2.7.9	Static Expressions	2-48
2.7.9.1	PLS_INTEGER Static Expressions	2-51
2.7.9.2	BOOLEAN Static Expressions	2-52
2.7.9.3	VARCHAR2 Static Expressions	2-53
2.7.9.4	Static Constants	2-53
2.8	Error-Reporting Functions	2-55
2.9	Conditional Compilation	2-55
2.9.1	How Conditional Compilation Works	2-55
2.9.1.1	Preprocessor Control Tokens	2-56
2.9.1.2	Selection Directives	2-56
2.9.1.3	Error Directives	2-57
2.9.1.4	Inquiry Directives	2-57
2.9.1.5	DBMS_DB_VERSION Package	2-61
2.9.2	Conditional Compilation Examples	2-61
2.9.3	Retrieving and Printing Post-Processed Source Text	2-63
2.9.4	Conditional Compilation Directive Restrictions	2-63

3 PL/SQL Data Types

3.1	SQL Data Types	3-2
3.1.1	Different Maximum Sizes	3-2

3.1.2	Additional PL/SQL Constants for BINARY_FLOAT and BINARY_DOUBLE	3-3
3.1.3	Additional PL/SQL Subtypes of BINARY_FLOAT and BINARY_DOUBLE	3-3
3.1.4	CHAR and VARCHAR2 Variables	3-4
3.1.4.1	Assigning or Inserting Too-Long Values	3-4
3.1.4.2	Declaring Variables for Multibyte Characters	3-5
3.1.4.3	Differences Between CHAR and VARCHAR2 Data Types	3-5
3.1.5	LONG and LONG RAW Variables	3-7
3.1.6	ROWID and UROWID Variables	3-7
3.2	BOOLEAN Data Type	3-8
3.3	PLS_INTEGER and BINARY_INTEGER Data Types	3-10
3.3.1	Preventing PLS_INTEGER Overflow	3-10
3.3.2	Predefined PLS_INTEGER Subtypes	3-11
3.3.3	SIMPLE_INTEGER Subtype of PLS_INTEGER	3-12
3.3.3.1	SIMPLE_INTEGER Overflow Semantics	3-13
3.3.3.2	Expressions with Both SIMPLE_INTEGER and Other Operands	3-13
3.3.3.3	Integer Literals in SIMPLE_INTEGER Range	3-13
3.4	User-Defined PL/SQL Subtypes	3-14
3.4.1	Unconstrained Subtypes	3-14
3.4.2	Constrained Subtypes	3-15
3.4.3	Subtypes with Base Types in Same Data Type Family	3-17

4 PL/SQL Control Statements

4.1	Conditional Selection Statements	4-1
4.1.1	IF THEN Statement	4-2
4.1.2	IF THEN ELSE Statement	4-3
4.1.3	IF THEN ELSIF Statement	4-5
4.1.4	Simple CASE Statement	4-7
4.1.5	Searched CASE Statement	4-8
4.2	LOOP Statements	4-9
4.2.1	Basic LOOP Statement	4-10
4.2.2	EXIT Statement	4-10
4.2.3	EXIT WHEN Statement	4-11
4.2.4	CONTINUE Statement	4-13
4.2.5	CONTINUE WHEN Statement	4-14
4.2.6	FOR LOOP Statement	4-15
4.2.6.1	FOR LOOP Index	4-17
4.2.6.2	Lower Bound and Upper Bound	4-19
4.2.6.3	EXIT WHEN or CONTINUE WHEN Statement in FOR LOOP Statement	4-20
4.2.7	WHILE LOOP Statement	4-22
4.3	Sequential Control Statements	4-22

4.3.1	GOTO Statement	4-23
4.3.2	NULL Statement	4-25

5 PL/SQL Collections and Records

5.1	Collection Types	5-2
5.2	Associative Arrays	5-4
5.2.1	Declaring Associative Array Constants	5-6
5.2.2	NLS Parameter Values Affect Associative Arrays Indexed by String	5-8
5.2.2.1	Changing NLS Parameter Values After Populating Associative Arrays	5-8
5.2.2.2	Indexes of Data Types Other Than VARCHAR2	5-8
5.2.2.3	Passing Associative Arrays to Remote Databases	5-9
5.2.3	Appropriate Uses for Associative Arrays	5-9
5.3	Varrays (Variable-Size Arrays)	5-10
5.3.1	Appropriate Uses for Varrays	5-12
5.4	Nested Tables	5-12
5.4.1	Important Differences Between Nested Tables and Arrays	5-15
5.4.2	Appropriate Uses for Nested Tables	5-16
5.5	Collection Constructors	5-16
5.6	Qualified Expressions Overview	5-17
5.7	Assigning Values to Collection Variables	5-20
5.7.1	Data Type Compatibility	5-20
5.7.2	Assigning Null Values to Varray or Nested Table Variables	5-21
5.7.3	Assigning Set Operation Results to Nested Table Variables	5-22
5.8	Multidimensional Collections	5-23
5.9	Collection Comparisons	5-25
5.9.1	Comparing Varray and Nested Table Variables to NULL	5-26
5.9.2	Comparing Nested Tables for Equality and Inequality	5-27
5.9.3	Comparing Nested Tables with SQL Multiset Conditions	5-28
5.10	Collection Methods	5-29
5.10.1	DELETE Collection Method	5-30
5.10.2	TRIM Collection Method	5-33
5.10.3	EXTEND Collection Method	5-35
5.10.4	EXISTS Collection Method	5-36
5.10.5	FIRST and LAST Collection Methods	5-37
5.10.5.1	FIRST and LAST Methods for Associative Array	5-37
5.10.5.2	FIRST and LAST Methods for Varray	5-38
5.10.5.3	FIRST and LAST Methods for Nested Table	5-40
5.10.6	COUNT Collection Method	5-41
5.10.6.1	COUNT Method for Varray	5-41
5.10.6.2	COUNT Method for Nested Table	5-42

5.10.7	LIMIT Collection Method	5-43
5.10.8	PRIOR and NEXT Collection Methods	5-44
5.11	Collection Types Defined in Package Specifications	5-46
5.12	Record Variables	5-48
5.12.1	Initial Values of Record Variables	5-48
5.12.2	Declaring Record Constants	5-48
5.12.3	RECORD Types	5-49
5.12.4	Declaring Items using the %ROWTYPE Attribute	5-53
5.12.4.1	Declaring a Record Variable that Always Represents Full Row	5-53
5.12.4.2	Declaring a Record Variable that Can Represent Partial Row	5-55
5.12.4.3	%ROWTYPE Attribute and Virtual Columns	5-56
5.12.4.4	%ROWTYPE Attribute and Invisible Columns	5-57
5.13	Assigning Values to Record Variables	5-58
5.13.1	Assigning One Record Variable to Another	5-59
5.13.2	Assigning Full or Partial Rows to Record Variables	5-61
5.13.2.1	Using SELECT INTO to Assign a Row to a Record Variable	5-61
5.13.2.2	Using FETCH to Assign a Row to a Record Variable	5-62
5.13.2.3	Using SQL Statements to Return Rows in PL/SQL Record Variables	5-63
5.13.3	Assigning NULL to a Record Variable	5-64
5.14	Record Comparisons	5-65
5.15	Inserting Records into Tables	5-65
5.16	Updating Rows with Records	5-66
5.17	Restrictions on Record Inserts and Updates	5-67

6 PL/SQL Static SQL

6.1	Description of Static SQL	6-1
6.1.1	Statements	6-1
6.1.2	Pseudocolumns	6-3
6.1.2.1	CURRVAL and NEXTVAL in PL/SQL	6-4
6.2	Cursors Overview	6-5
6.2.1	Implicit Cursors	6-7
6.2.1.1	SQL%ISOPEN Attribute: Is the Cursor Open?	6-7
6.2.1.2	SQL%FOUND Attribute: Were Any Rows Affected?	6-7
6.2.1.3	SQL%NOTFOUND Attribute: Were No Rows Affected?	6-8
6.2.1.4	SQL%ROWCOUNT Attribute: How Many Rows Were Affected?	6-8
6.2.2	Explicit Cursors	6-9
6.2.2.1	Declaring and Defining Explicit Cursors	6-10
6.2.2.2	Opening and Closing Explicit Cursors	6-11
6.2.2.3	Fetching Data with Explicit Cursors	6-11
6.2.2.4	Variables in Explicit Cursor Queries	6-14

6.2.2.5	When Explicit Cursor Queries Need Column Aliases	6-15
6.2.2.6	Explicit Cursors that Accept Parameters	6-16
6.2.2.7	Explicit Cursor Attributes	6-20
6.3	Processing Query Result Sets	6-24
6.3.1	Processing Query Result Sets With SELECT INTO Statements	6-25
6.3.1.1	Handling Single-Row Result Sets	6-26
6.3.1.2	Handling Large Multiple-Row Result Sets	6-26
6.3.2	Processing Query Result Sets With Cursor FOR LOOP Statements	6-26
6.3.3	Processing Query Result Sets With Explicit Cursors, OPEN, FETCH, and CLOSE	6-29
6.3.4	Processing Query Result Sets with Subqueries	6-29
6.4	Cursor Variables	6-30
6.4.1	Creating Cursor Variables	6-32
6.4.2	Opening and Closing Cursor Variables	6-33
6.4.3	Fetching Data with Cursor Variables	6-34
6.4.4	Assigning Values to Cursor Variables	6-36
6.4.5	Variables in Cursor Variable Queries	6-36
6.4.6	Querying a Collection	6-38
6.4.7	Cursor Variable Attributes	6-39
6.4.8	Cursor Variables as Subprogram Parameters	6-39
6.4.9	Cursor Variables as Host Variables	6-42
6.5	CURSOR Expressions	6-43
6.6	Transaction Processing and Control	6-45
6.6.1	COMMIT Statement	6-45
6.6.2	ROLLBACK Statement	6-47
6.6.3	SAVEPOINT Statement	6-48
6.6.4	Implicit Rollbacks	6-50
6.6.5	SET TRANSACTION Statement	6-51
6.6.6	Overriding Default Locking	6-52
6.6.6.1	LOCK TABLE Statement	6-52
6.6.6.2	SELECT FOR UPDATE and FOR UPDATE Cursors	6-53
6.6.6.3	Simulating CURRENT OF Clause with ROWID Pseudocolumn	6-53
6.7	Autonomous Transactions	6-55
6.7.1	Advantages of Autonomous Transactions	6-57
6.7.2	Transaction Context	6-57
6.7.3	Transaction Visibility	6-57
6.7.4	Declaring Autonomous Routines	6-57
6.7.5	Controlling Autonomous Transactions	6-59
6.7.5.1	Entering and Exiting Autonomous Routines	6-59
6.7.5.2	Committing and Rolling Back Autonomous Transactions	6-59
6.7.5.3	Savepoints	6-60

6.7.5.4	Avoiding Errors with Autonomous Transactions	6-60
6.7.6	Autonomous Triggers	6-60
6.7.7	Invoking Autonomous Functions from SQL	6-62

7 PL/SQL Dynamic SQL

7.1	When You Need Dynamic SQL	7-1
7.2	Native Dynamic SQL	7-2
7.2.1	EXECUTE IMMEDIATE Statement	7-2
7.2.2	OPEN FOR, FETCH, and CLOSE Statements	7-8
7.2.3	Repeated Placeholder Names in Dynamic SQL Statements	7-9
7.2.3.1	Dynamic SQL Statement is Not Anonymous Block or CALL Statement	7-9
7.2.3.2	Dynamic SQL Statement is Anonymous Block or CALL Statement	7-10
7.3	DBMS_SQL Package	7-11
7.3.1	DBMS_SQL.RETURN_RESULT Procedure	7-12
7.3.2	DBMS_SQL.GET_NEXT_RESULT Procedure	7-13
7.3.3	DBMS_SQL.TO_REFCURSOR Function	7-15
7.3.4	DBMS_SQL.TO_CURSOR_NUMBER Function	7-16
7.4	SQL Injection	7-17
7.4.1	SQL Injection Techniques	7-18
7.4.1.1	Statement Modification	7-18
7.4.1.2	Statement Injection	7-20
7.4.1.3	Data Type Conversion	7-21
7.4.2	Guards Against SQL Injection	7-23
7.4.2.1	Bind Variables	7-23
7.4.2.2	Validation Checks	7-25
7.4.2.3	Explicit Format Models	7-26

8 PL/SQL Subprograms

8.1	Reasons to Use Subprograms	8-1
8.2	Nested, Package, and Standalone Subprograms	8-2
8.3	Subprogram Invocations	8-2
8.4	Subprogram Properties	8-3
8.5	Subprogram Parts	8-3
8.5.1	Additional Parts for Functions	8-5
8.5.2	RETURN Statement	8-6
8.5.2.1	RETURN Statement in Function	8-6
8.5.2.2	RETURN Statement in Procedure	8-8
8.5.2.3	RETURN Statement in Anonymous Block	8-8
8.6	Forward Declaration	8-9

8.7	Subprogram Parameters	8-9
8.7.1	Formal and Actual Subprogram Parameters	8-10
8.7.1.1	Formal Parameters of Constrained Subtypes	8-12
8.7.2	Subprogram Parameter Passing Methods	8-14
8.7.3	Subprogram Parameter Modes	8-15
8.7.4	Subprogram Parameter Aliasing	8-20
8.7.4.1	Subprogram Parameter Aliasing with Parameters Passed by Reference	8-20
8.7.4.2	Subprogram Parameter Aliasing with Cursor Variable Parameters	8-22
8.7.5	Default Values for IN Subprogram Parameters	8-23
8.7.6	Positional, Named, and Mixed Notation for Actual Parameters	8-26
8.8	Subprogram Invocation Resolution	8-28
8.9	Overloaded Subprograms	8-30
8.9.1	Formal Parameters that Differ Only in Numeric Data Type	8-31
8.9.2	Subprograms that You Cannot Overload	8-33
8.9.3	Subprogram Overload Errors	8-33
8.10	Recursive Subprograms	8-35
8.11	Subprogram Side Effects	8-37
8.12	PL/SQL Function Result Cache	8-37
8.12.1	Enabling Result-Caching for a Function	8-38
8.12.2	Developing Applications with Result-Cached Functions	8-39
8.12.3	Requirements for Result-Cached Functions	8-39
8.12.4	Examples of Result-Cached Functions	8-40
8.12.4.1	Result-Cached Application Configuration Parameters	8-40
8.12.4.2	Result-Cached Recursive Function	8-42
8.12.5	Advanced Result-Cached Function Topics	8-42
8.12.5.1	Rules for a Cache Hit	8-42
8.12.5.2	Result Cache Bypass	8-43
8.12.5.3	Making Result-Cached Functions Handle Session-Specific Settings	8-43
8.12.5.4	Making Result-Cached Functions Handle Session-Specific Application Contexts	8-44
8.12.5.5	Choosing Result-Caching Granularity	8-45
8.12.5.6	Result Caches in Oracle RAC Environment	8-47
8.12.5.7	Result Cache Management	8-47
8.12.5.8	Hot-Patching PL/SQL Units on Which Result-Cached Functions Depend	8-48
8.13	PL/SQL Functions that SQL Statements Can Invoke	8-49
8.14	Invoker's Rights and Definer's Rights (AUTHID Property)	8-50
8.14.1	Granting Roles to PL/SQL Packages and Standalone Subprograms	8-52
8.14.2	IR Units Need Template Objects	8-52
8.14.3	Connected User Database Links in DR Units	8-53
8.15	External Subprograms	8-53

9 PL/SQL Triggers

9.1	Overview of Triggers	9-1
9.2	Reasons to Use Triggers	9-3
9.3	DML Triggers	9-4
9.3.1	Conditional Predicates for Detecting Triggering DML Statement	9-5
9.3.2	INSTEAD OF DML Triggers	9-6
9.3.3	Compound DML Triggers	9-10
9.3.3.1	Compound DML Trigger Structure	9-11
9.3.3.2	Compound DML Trigger Restrictions	9-11
9.3.3.3	Performance Benefit of Compound DML Triggers	9-12
9.3.3.4	Using Compound DML Triggers with Bulk Insertion	9-12
9.3.3.5	Using Compound DML Triggers to Avoid Mutating-Table Error	9-15
9.3.4	Triggers for Ensuring Referential Integrity	9-16
9.3.4.1	Foreign Key Trigger for Child Table	9-17
9.3.4.2	UPDATE and DELETE RESTRICT Trigger for Parent Table	9-18
9.3.4.3	UPDATE and DELETE SET NULL Trigger for Parent Table	9-19
9.3.4.4	DELETE CASCADE Trigger for Parent Table	9-19
9.3.4.5	UPDATE CASCADE Trigger for Parent Table	9-20
9.3.4.6	Triggers for Complex Constraint Checking	9-21
9.3.4.7	Triggers for Complex Security Authorizations	9-22
9.3.4.8	Triggers for Transparent Event Logging	9-24
9.3.4.9	Triggers for Deriving Column Values	9-24
9.3.4.10	Triggers for Building Complex Updatable Views	9-24
9.3.4.11	Triggers for Fine-Grained Access Control	9-28
9.4	Correlation Names and Pseudorecords	9-28
9.4.1	OBJECT_VALUE Pseudocolumn	9-32
9.5	System Triggers	9-34
9.5.1	SCHEMA Triggers	9-34
9.5.2	DATABASE Triggers	9-35
9.5.3	INSTEAD OF CREATE Triggers	9-36
9.6	Subprograms Invoked by Triggers	9-36
9.7	Trigger Compilation, Invalidation, and Recompilation	9-37
9.8	Exception Handling in Triggers	9-38
9.9	Trigger Design Guidelines	9-39
9.10	Trigger Restrictions	9-41
9.10.1	Trigger Size Restriction	9-41
9.10.2	Trigger LONG and LONG RAW Data Type Restrictions	9-42
9.10.3	Mutating-Table Restriction	9-42
9.11	Order in Which Triggers Fire	9-46
9.12	Trigger Enabling and Disabling	9-47

9.13	Trigger Changing and Debugging	9-47
9.14	Triggers and Oracle Database Data Transfer Utilities	9-48
9.15	Triggers for Publishing Events	9-49
9.15.1	Event Attribute Functions	9-50
9.15.2	Event Attribute Functions for Database Event Triggers	9-55
9.15.3	Event Attribute Functions for Client Event Triggers	9-55
9.16	Views for Information About Triggers	9-61

10 PL/SQL Packages

10.1	What is a Package?	10-1
10.2	Reasons to Use Packages	10-2
10.3	Package Specification	10-3
10.3.1	Appropriate Public Items	10-4
10.3.2	Creating Package Specifications	10-5
10.4	Package Body	10-6
10.5	Package Instantiation and Initialization	10-7
10.6	Package State	10-7
10.7	SERIALLY_REUSABLE Packages	10-8
10.7.1	Creating SERIALLY_REUSABLE Packages	10-9
10.7.2	SERIALLY_REUSABLE Package Work Unit	10-9
10.7.3	Explicit Cursors in SERIALLY_REUSABLE Packages	10-11
10.8	Package Writing Guidelines	10-12
10.9	Package Example	10-14
10.10	How STANDARD Package Defines the PL/SQL Environment	10-18

11 PL/SQL Error Handling

11.1	Compile-Time Warnings	11-2
11.1.1	DBMS_WARNING Package	11-4
11.2	Overview of Exception Handling	11-5
11.2.1	Exception Categories	11-6
11.2.2	Advantages of Exception Handlers	11-7
11.2.3	Guidelines for Avoiding and Handling Exceptions	11-9
11.3	Internally Defined Exceptions	11-10
11.4	Predefined Exceptions	11-11
11.5	User-Defined Exceptions	11-14
11.6	Redeclared Predefined Exceptions	11-14
11.7	Raising Exceptions Explicitly	11-16
11.7.1	RAISE Statement	11-16
11.7.1.1	Raising User-Defined Exception with RAISE Statement	11-16

11.7.1.2	Raising Internally Defined Exception with RAISE Statement	11-17
11.7.1.3	Reraising Current Exception with RAISE Statement	11-17
11.7.2	RAISE_APPLICATION_ERROR Procedure	11-18
11.8	Exception Propagation	11-19
11.8.1	Propagation of Exceptions Raised in Declarations	11-22
11.8.2	Propagation of Exceptions Raised in Exception Handlers	11-23
11.9	Unhandled Exceptions	11-27
11.10	Retrieving Error Code and Error Message	11-27
11.11	Continuing Execution After Handling Exceptions	11-28
11.12	Retrying Transactions After Handling Exceptions	11-30
11.13	Handling Errors in Distributed Queries	11-31

12 PL/SQL Optimization and Tuning

12.1	PL/SQL Optimizer	12-1
12.1.1	Subprogram Inlining	12-2
12.2	Candidates for Tuning	12-4
12.3	Minimizing CPU Overhead	12-5
12.3.1	Tune SQL Statements	12-5
12.3.2	Tune Function Invocations in Queries	12-6
12.3.3	Tune Subprogram Invocations	12-7
12.3.4	Tune Loops	12-9
12.3.5	Tune Computation-Intensive PL/SQL Code	12-9
12.3.5.1	Use Data Types that Use Hardware Arithmetic	12-9
12.3.5.2	Avoid Constrained Subtypes in Performance-Critical Code	12-10
12.3.5.3	Minimize Implicit Data Type Conversion	12-10
12.3.6	Use SQL Character Functions	12-11
12.3.7	Put Least Expensive Conditional Tests First	12-12
12.4	Bulk SQL and Bulk Binding	12-12
12.4.1	FORALL Statement	12-13
12.4.1.1	Using FORALL Statements for Sparse Collections	12-16
12.4.1.2	Unhandled Exceptions in FORALL Statements	12-19
12.4.1.3	Handling FORALL Exceptions Immediately	12-19
12.4.1.4	Handling FORALL Exceptions After FORALL Statement Completes	12-21
12.4.1.5	Getting Number of Rows Affected by FORALL Statement	12-24
12.4.2	BULK COLLECT Clause	12-26
12.4.2.1	SELECT INTO Statement with BULK COLLECT Clause	12-26
12.4.2.2	FETCH Statement with BULK COLLECT Clause	12-34
12.4.2.3	RETURNING INTO Clause with BULK COLLECT Clause	12-38
12.4.3	Using FORALL Statement and BULK COLLECT Clause Together	12-39
12.4.4	Client Bulk-Binding of Host Arrays	12-41

12.5	Chaining Pipelined Table Functions for Multiple Transformations	12-41
12.5.1	Overview of Table Functions	12-42
12.5.2	Creating Pipelined Table Functions	12-43
12.5.3	Pipelined Table Functions as Transformation Functions	12-45
12.5.4	Chaining Pipelined Table Functions	12-46
12.5.5	Fetching from Results of Pipelined Table Functions	12-47
12.5.6	Passing CURSOR Expressions to Pipelined Table Functions	12-47
12.5.7	DML Statements on Pipelined Table Function Results	12-50
12.5.8	NO_DATA_NEEDED Exception	12-51
12.6	Overview of Polymorphic Table Functions	12-53
12.6.1	Polymorphic Table Function Definition	12-53
12.6.2	Polymorphic Table Function Implementation	12-54
12.6.3	Polymorphic Table Function Invocation	12-54
12.6.3.1	Variadic Pseudo-Operators	12-56
12.6.3.2	COLUMNS Pseudo-Operator	12-56
12.6.4	Polymorphic Table Function Compilation and Execution	12-57
12.6.5	Polymorphic Table Function Optimization	12-57
12.6.6	Skip_col Polymorphic Table Function Example	12-57
12.6.7	To_doc Polymorphic Table Function Example	12-61
12.6.8	Implicit_echo Polymorphic Table Function Example	12-65
12.7	Updating Large Tables in Parallel	12-67
12.8	Collecting Data About User-Defined Identifiers	12-68
12.9	Profiling and Tracing PL/SQL Programs	12-68
12.10	Compiling PL/SQL Units for Native Execution	12-70
12.10.1	Determining Whether to Use PL/SQL Native Compilation	12-70
12.10.2	How PL/SQL Native Compilation Works	12-71
12.10.3	Dependencies, Invalidation, and Revalidation	12-71
12.10.4	Setting Up a New Database for PL/SQL Native Compilation	12-72
12.10.5	Compiling the Entire Database for PL/SQL Native or Interpreted Compilation	12-72

13 PL/SQL Language Elements

13.1	ACCESSIBLE BY Clause	13-3
13.2	AGGREGATE Clause	13-8
13.3	Assignment Statement	13-9
13.4	AUTONOMOUS_TRANSACTION Pragma	13-12
13.5	Basic LOOP Statement	13-13
13.6	Block	13-14
13.7	Call Specification	13-23
13.8	CASE Statement	13-26
13.9	CLOSE Statement	13-29

13.10	Collection Method Invocation	13-30
13.11	Collection Variable Declaration	13-33
13.12	Comment	13-38
13.13	COMPILE Clause	13-39
13.14	Constant Declaration	13-42
13.15	CONTINUE Statement	13-43
13.16	COVERAGE Pragma	13-45
13.17	Cursor FOR LOOP Statement	13-48
13.18	Cursor Variable Declaration	13-50
13.19	Datatype Attribute	13-53
13.20	DEFAULT COLLATION Clause	13-54
13.21	DELETE Statement Extension	13-56
13.22	DEPRECATE Pragma	13-56
13.23	DETERMINISTIC Clause	13-66
13.24	Element Specification	13-68
13.25	EXCEPTION_INIT Pragma	13-74
13.26	Exception Declaration	13-75
13.27	Exception Handler	13-76
13.28	EXECUTE IMMEDIATE Statement	13-78
13.29	EXIT Statement	13-81
13.30	Explicit Cursor Declaration and Definition	13-83
13.31	Expression	13-86
13.32	FETCH Statement	13-99
13.33	FOR LOOP Statement	13-101
13.34	FORALL Statement	13-103
13.35	Formal Parameter Declaration	13-106
13.36	Function Declaration and Definition	13-108
13.37	GOTO Statement	13-111
13.38	IF Statement	13-112
13.39	Implicit Cursor Attribute	13-113
13.40	INLINE Pragma	13-115
13.41	Invoker's Rights and Definer's Rights Clause	13-117
13.42	INSERT Statement Extension	13-118
13.43	Named Cursor Attribute	13-119
13.44	NULL Statement	13-122
13.45	OPEN Statement	13-122
13.46	OPEN FOR Statement	13-124
13.47	PARALLEL_ENABLE Clause	13-126
13.48	PIPE ROW Statement	13-129
13.49	PIPELINED Clause	13-130
13.50	Procedure Declaration and Definition	13-133

13.51	RAISE Statement	13-136
13.52	Record Variable Declaration	13-137
13.53	RESTRICT_REFERENCES Pragma	13-139
13.54	RETURN Statement	13-141
13.55	RETURNING INTO Clause	13-142
13.56	RESULT_CACHE Clause	13-145
13.57	%ROWTYPE Attribute	13-147
13.58	Scalar Variable Declaration	13-149
13.59	SELECT INTO Statement	13-150
13.60	SERIALLY_REUSABLE Pragma	13-153
13.61	SHARING Clause	13-153
13.62	SQLCODE Function	13-155
13.63	SQLERRM Function	13-156
13.64	SQL_MACRO Clause	13-158
13.65	%TYPE Attribute	13-160
13.66	UDF Pragma	13-162
13.67	UPDATE Statement Extensions	13-162
13.68	WHILE LOOP Statement	13-164

14 SQL Statements for Stored PL/SQL Units

14.1	ALTER FUNCTION Statement	14-2
14.2	ALTER LIBRARY Statement	14-4
14.3	ALTER PACKAGE Statement	14-6
14.4	ALTER PROCEDURE Statement	14-8
14.5	ALTER TRIGGER Statement	14-10
14.6	ALTER TYPE Statement	14-13
14.7	CREATE FUNCTION Statement	14-25
14.8	CREATE LIBRARY Statement	14-31
14.9	CREATE PACKAGE Statement	14-35
14.10	CREATE PACKAGE BODY Statement	14-38
14.11	CREATE PROCEDURE Statement	14-42
14.12	CREATE TRIGGER Statement	14-45
14.13	CREATE TYPE Statement	14-65
14.14	CREATE TYPE BODY Statement	14-76
14.15	DROP FUNCTION Statement	14-80
14.16	DROP LIBRARY Statement	14-82
14.17	DROP PACKAGE Statement	14-83
14.18	DROP PROCEDURE Statement	14-85
14.19	DROP TRIGGER Statement	14-86
14.20	DROP TYPE Statement	14-87

A PL/SQL Source Text Wrapping

A.1	PL/SQL Source Text Wrapping Limitations	A-2
A.2	PL/SQL Source Text Wrapping Guidelines	A-2
A.3	Wrapping PL/SQL Source Text with PL/SQL Wrapper Utility	A-2
A.4	Wrapping PL/SQL Source Text with DBMS_DDL Subprograms	A-8

B PL/SQL Name Resolution

B.1	Qualified Names and Dot Notation	B-1
B.2	Column Name Precedence	B-3
B.3	Differences Between PL/SQL and SQL Name Resolution Rules	B-5
B.4	Resolution of Names in Static SQL Statements	B-6
B.5	What is Capture?	B-6
B.5.1	Outer Capture	B-7
B.5.2	Same-Scope Capture	B-7
B.5.3	Inner Capture	B-7
B.6	Avoiding Inner Capture in SELECT and DML Statements	B-8
B.6.1	Qualifying References to Attributes and Methods	B-9
B.6.2	Qualifying References to Row Expressions	B-10

C PL/SQL Program Limits

D PL/SQL Reserved Words and Keywords

E PL/SQL Predefined Data Types

Index

List of Examples

1-1	PL/SQL Block Structure	1-5
1-2	Processing Query Result Rows One at a Time	1-9
2-1	Valid Case-Insensitive Reference to Quoted User-Defined Identifier	2-8
2-2	Invalid Case-Insensitive Reference to Quoted User-Defined Identifier	2-9
2-3	Reserved Word as Quoted User-Defined Identifier	2-9
2-4	Neglecting Double Quotation Marks	2-9
2-5	Neglecting Case-Sensitivity	2-10
2-6	Single-Line Comments	2-13
2-7	Multiline Comments	2-14
2-8	Whitespace Characters Improving Source Text Readability	2-15
2-9	Variable Declaration with NOT NULL Constraint	2-16
2-10	Variables Initialized to NULL Values	2-16
2-11	Scalar Variable Declarations	2-17
2-12	Constant Declarations	2-17
2-13	Variable and Constant Declarations with Initial Values	2-18
2-14	Variable Initialized to NULL by Default	2-18
2-15	Declaring Variable of Same Type as Column	2-19
2-16	Declaring Variable of Same Type as Another Variable	2-19
2-17	Scope and Visibility of Identifiers	2-21
2-18	Qualifying Redeclared Global Identifier with Block Label	2-22
2-19	Qualifying Identifier with Subprogram Name	2-22
2-20	Duplicate Identifiers in Same Scope	2-23
2-21	Declaring Same Identifier in Different Units	2-23
2-22	Label and Subprogram with Same Name in Same Scope	2-24
2-23	Block with Multiple and Duplicate Labels	2-24
2-24	Assigning Values to Variables with Assignment Statement	2-26
2-25	Assigning Value to Variable with SELECT INTO Statement	2-27
2-26	Assigning Value to Variable as IN OUT Subprogram Parameter	2-27
2-27	Assigning Value to BOOLEAN Variable	2-28
2-28	Concatenation Operator	2-29
2-29	Concatenation Operator with NULL Operands	2-29
2-30	Controlling Evaluation Order with Parentheses	2-30
2-31	Expression with Nested Parentheses	2-30
2-32	Improving Readability with Parentheses	2-31
2-33	Operator Precedence	2-31

2-34	Procedure Prints BOOLEAN Variable	2-32
2-35	AND Operator	2-33
2-36	OR Operator	2-34
2-37	NOT Operator	2-35
2-38	NULL Value in Unequal Comparison	2-35
2-39	NULL Value in Equal Comparison	2-36
2-40	NOT NULL Equals NULL	2-36
2-41	Changing Evaluation Order of Logical Operators	2-36
2-42	Short-Circuit Evaluation	2-37
2-43	Relational Operators in Expressions	2-39
2-44	LIKE Operator in Expression	2-41
2-45	Escape Character in Pattern	2-41
2-46	BETWEEN Operator in Expressions	2-42
2-47	IN Operator in Expressions	2-43
2-48	IN Operator with Sets with NULL Values	2-43
2-49	Equivalent BOOLEAN Expressions	2-44
2-50	Simple CASE Expression	2-45
2-51	Simple CASE Expression with WHEN NULL	2-45
2-52	Searched CASE Expression	2-46
2-53	Searched CASE Expression with WHEN ... IS NULL	2-47
2-54	Static Constants	2-54
2-55	Predefined Inquiry Directives	2-58
2-56	Displaying Values of PL/SQL Compilation Parameters	2-59
2-57	PLSQL_CCFLAGS Assigns Value to Itself	2-60
2-58	Code for Checking Database Version	2-61
2-59	Compiling Different Code for Different Database Versions	2-62
2-60	Displaying Post-Processed Source Textsource text	2-63
2-61	Using Conditional Compilation Directive in the Definition of a Package Specification	2-64
2-62	Using Conditional Compilation Directive in the Formal Parameter List of a Subprogram	2-65
3-1	CHAR and VARCHAR2 Blank-Padding Difference	3-6
3-2	Printing BOOLEAN Values	3-9
3-3	SQL Statement Invokes PL/SQL Function with BOOLEAN Parameter	3-9
3-4	PLS_INTEGER Calculation Raises Overflow Exception	3-10
3-5	Preventing Overflow	3-11
3-6	Violating Constraint of SIMPLE_INTEGER Subtype	3-12
3-7	User-Defined Unconstrained Subtypes Show Intended Use	3-14
3-8	User-Defined Constrained Subtype Detects Out-of-Range Values	3-16

3-9	Implicit Conversion Between Constrained Subtypes with Same Base Type	3-16
3-10	Implicit Conversion Between Subtypes with Base Types in Same Family	3-17
4-1	IF THEN Statement	4-3
4-2	IF THEN ELSE Statement	4-4
4-3	Nested IF THEN ELSE Statements	4-4
4-4	IF THEN ELSIF Statement	4-6
4-5	IF THEN ELSIF Statement Simulates Simple CASE Statement	4-6
4-6	Simple CASE Statement	4-7
4-7	Searched CASE Statement	4-8
4-8	EXCEPTION Instead of ELSE Clause in CASE Statement	4-8
4-9	Basic LOOP Statement with EXIT Statement	4-10
4-10	Basic LOOP Statement with EXIT WHEN Statement	4-11
4-11	Nested, Labeled Basic LOOP Statements with EXIT WHEN Statements	4-12
4-12	Nested, Unlabeled Basic LOOP Statements with EXIT WHEN Statements	4-12
4-13	CONTINUE Statement in Basic LOOP Statement	4-13
4-14	CONTINUE WHEN Statement in Basic LOOP Statement	4-14
4-15	FOR LOOP Statements	4-16
4-16	Reverse FOR LOOP Statements	4-16
4-17	Simulating STEP Clause in FOR LOOP Statement	4-17
4-18	FOR LOOP Statement Tries to Change Index Value	4-17
4-19	Outside Statement References FOR LOOP Statement Index	4-18
4-20	FOR LOOP Statement Index with Same Name as Variable	4-18
4-21	FOR LOOP Statement References Variable with Same Name as Index	4-18
4-22	Nested FOR LOOP Statements with Same Index Name	4-19
4-23	FOR LOOP Statement Bounds	4-19
4-24	Specifying FOR LOOP Statement Bounds at Run Time	4-20
4-25	EXIT WHEN Statement in FOR LOOP Statement	4-21
4-26	EXIT WHEN Statement in Inner FOR LOOP Statement	4-21
4-27	CONTINUE WHEN Statement in Inner FOR LOOP Statement	4-21
4-28	WHILE LOOP Statements	4-22
4-29	GOTO Statement	4-23
4-30	Incorrect Label Placement	4-24
4-31	GOTO Statement Goes to Labeled NULL Statement	4-24
4-32	GOTO Statement Transfers Control to Enclosing Block	4-24
4-33	GOTO Statement Cannot Transfer Control into IF Statement	4-25
4-34	NULL Statement Showing No Action	4-26
4-35	NULL Statement as Placeholder During Subprogram Creation	4-26

4-36	NULL Statement in ELSE Clause of Simple CASE Statement	4-26
5-1	Associative Array Indexed by String	5-5
5-2	Function Returns Associative Array Indexed by PLS_INTEGER	5-6
5-3	Declaring Associative Array Constant	5-6
5-4	Varray (Variable-Size Array)	5-11
5-5	Nested Table of Local Type	5-13
5-6	Nested Table of Standalone Type	5-14
5-7	Initializing Collection (Varray) Variable to Empty	5-17
5-8	Assigning Values to RECORD Type Variables Using Qualified Expressions	5-18
5-9	Assigning Values to Associative Array Type Variables Using Qualified Expressions	5-19
5-10	Data Type Compatibility for Collection Assignment	5-21
5-11	Assigning Null Value to Nested Table Variable	5-21
5-12	Assigning Set Operation Results to Nested Table Variable	5-22
5-13	Two-Dimensional Varray (Varray of Varrays)	5-23
5-14	Nested Tables of Nested Tables and Varrays of Integers	5-24
5-15	Nested Tables of Associative Arrays and Varrays of Strings	5-25
5-16	Comparing Varray and Nested Table Variables to NULL	5-26
5-17	Comparing Nested Tables for Equality and Inequality	5-27
5-18	Comparing Nested Tables with SQL Multiset Conditions	5-28
5-19	DELETE Method with Nested Table	5-31
5-20	DELETE Method with Associative Array Indexed by String	5-32
5-21	TRIM Method with Nested Table	5-34
5-22	EXTEND Method with Nested Table	5-35
5-23	EXISTS Method with Nested Table	5-36
5-24	FIRST and LAST Values for Associative Array Indexed by PLS_INTEGER	5-37
5-25	FIRST and LAST Values for Associative Array Indexed by String	5-38
5-26	Printing Varray with FIRST and LAST in FOR LOOP	5-39
5-27	Printing Nested Table with FIRST and LAST in FOR LOOP	5-40
5-28	COUNT and LAST Values for Varray	5-41
5-29	COUNT and LAST Values for Nested Table	5-42
5-30	LIMIT and COUNT Values for Different Collection Types	5-43
5-31	PRIOR and NEXT Methods	5-44
5-32	Printing Elements of Sparse Nested Table	5-45
5-33	Identically Defined Package and Local Collection Types	5-46
5-34	Identically Defined Package and Standalone Collection Types	5-47
5-35	Declaring Record Constant	5-49
5-36	RECORD Type Definition and Variable Declaration	5-50

5-37	RECORD Type with RECORD Field (Nested Record)	5-50
5-38	RECORD Type with Varray Field	5-51
5-39	Identically Defined Package and Local RECORD Types	5-52
5-40	%ROWTYPE Variable Represents Full Database Table Row	5-53
5-41	%ROWTYPE Variable Does Not Inherit Initial Values or Constraints	5-54
5-42	%ROWTYPE Variable Represents Partial Database Table Row	5-55
5-43	%ROWTYPE Variable Represents Join Row	5-56
5-44	Inserting %ROWTYPE Record into Table (Wrong)	5-56
5-45	Inserting %ROWTYPE Record into Table (Right)	5-57
5-46	%ROWTYPE Affected by Making Invisible Column Visible	5-58
5-47	Assigning Record to Another Record of Same RECORD Type	5-59
5-48	Assigning %ROWTYPE Record to RECORD Type Record	5-59
5-49	Assigning Nested Record to Another Record of Same RECORD Type	5-60
5-50	SELECT INTO Assigns Values to Record Variable	5-61
5-51	FETCH Assigns Values to Record that Function Returns	5-62
5-52	UPDATE Statement Assigns Values to Record Variable	5-63
5-53	Assigning NULL to Record Variable	5-64
5-54	Initializing Table by Inserting Record of Default Values	5-65
5-55	Updating Rows with Record	5-66
6-1	Static SQL Statements	6-2
6-2	CURRVAL and NEXTVAL Pseudocolumns	6-4
6-3	SQL%FOUND Implicit Cursor Attribute	6-8
6-4	SQL%ROWCOUNT Implicit Cursor Attribute	6-9
6-5	Explicit Cursor Declaration and Definition	6-10
6-6	FETCH Statements Inside LOOP Statements	6-12
6-7	Fetching Same Explicit Cursor into Different Variables	6-13
6-8	Variable in Explicit Cursor Query—No Result Set Change	6-14
6-9	Variable in Explicit Cursor Query—Result Set Change	6-15
6-10	Explicit Cursor with Virtual Column that Needs Alias	6-16
6-11	Explicit Cursor that Accepts Parameters	6-17
6-12	Cursor Parameters with Default Values	6-18
6-13	Adding Formal Parameter to Existing Cursor	6-19
6-14	%ISOPEN Explicit Cursor Attribute	6-21
6-15	%FOUND Explicit Cursor Attribute	6-22
6-16	%NOTFOUND Explicit Cursor Attribute	6-23
6-17	%ROWCOUNT Explicit Cursor Attribute	6-24
6-18	Implicit Cursor FOR LOOP Statement	6-27

6-19	Explicit Cursor FOR LOOP Statement	6-27
6-20	Passing Parameters to Explicit Cursor FOR LOOP Statement	6-28
6-21	Cursor FOR Loop References Virtual Columns	6-28
6-22	Subquery in FROM Clause of Parent Query	6-29
6-23	Correlated Subquery	6-30
6-24	Cursor Variable Declarations	6-32
6-25	Cursor Variable with User-Defined Return Type	6-33
6-26	Fetching Data with Cursor Variables	6-34
6-27	Fetching from Cursor Variable into Collections	6-35
6-28	Variable in Cursor Variable Query—No Result Set Change	6-36
6-29	Variable in Cursor Variable Query—Result Set Change	6-37
6-30	Querying a Collection with Static SQL	6-39
6-31	Procedure to Open Cursor Variable for One Query	6-41
6-32	Opening Cursor Variable for Chosen Query (Same Return Type)	6-41
6-33	Opening Cursor Variable for Chosen Query (Different Return Types)	6-41
6-34	Cursor Variable as Host Variable in Pro*C Client Program	6-43
6-35	CURSOR Expression	6-44
6-36	COMMIT Statement with COMMENT and WRITE Clauses	6-46
6-37	ROLLBACK Statement	6-47
6-38	SAVEPOINT and ROLLBACK Statements	6-49
6-39	Reusing SAVEPOINT with ROLLBACK	6-50
6-40	SET TRANSACTION Statement in Read-Only Transaction	6-51
6-41	FETCH with FOR UPDATE Cursor After COMMIT Statement	6-54
6-42	Simulating CURRENT OF Clause with ROWID Pseudocolumn	6-55
6-43	Declaring Autonomous Function in Package	6-58
6-44	Declaring Autonomous Standalone Procedure	6-58
6-45	Declaring Autonomous PL/SQL Block	6-58
6-46	Autonomous Trigger Logs INSERT Statements	6-61
6-47	Autonomous Trigger Uses Native Dynamic SQL for DDL	6-62
6-48	Invoking Autonomous Function	6-63
7-1	Invoking Subprogram from Dynamic PL/SQL Block	7-4
7-2	Dynamically Invoking Subprogram with BOOLEAN Formal Parameter	7-5
7-3	Dynamically Invoking Subprogram with RECORD Formal Parameter	7-5
7-4	Dynamically Invoking Subprogram with Assoc. Array Formal Parameter	7-6
7-5	Dynamically Invoking Subprogram with Nested Table Formal Parameter	7-7
7-6	Dynamically Invoking Subprogram with Varray Formal Parameter	7-7
7-7	Uninitialized Variable Represents NULL in USING Clause	7-8

7-8	Native Dynamic SQL with OPEN FOR, FETCH, and CLOSE Statements	7-8
7-9	Querying a Collection with Native Dynamic SQL	7-9
7-10	Repeated Placeholder Names in Dynamic PL/SQL Block	7-10
7-11	DBMS_SQL.RETURN_RESULT Procedure	7-12
7-12	DBMS_SQL.GET_NEXT_RESULT Procedure	7-14
7-13	Switching from DBMS_SQL Package to Native Dynamic SQL	7-15
7-14	Switching from Native Dynamic SQL to DBMS_SQL Package	7-16
7-15	Setup for SQL Injection Examples	7-17
7-16	Procedure Vulnerable to Statement Modification	7-18
7-17	Procedure Vulnerable to Statement Injection	7-20
7-18	Procedure Vulnerable to SQL Injection Through Data Type Conversion	7-22
7-19	Bind Variables Guarding Against SQL Injection	7-23
7-20	Validation Checks Guarding Against SQL Injection	7-25
7-21	Explicit Format Models Guarding Against SQL Injection	7-27
8-1	Declaring, Defining, and Invoking a Simple PL/SQL Procedure	8-4
8-2	Declaring, Defining, and Invoking a Simple PL/SQL Function	8-5
8-3	Execution Resumes After RETURN Statement in Function	8-7
8-4	Function Where Not Every Execution Path Leads to RETURN Statement	8-7
8-5	Function Where Every Execution Path Leads to RETURN Statement	8-7
8-6	Execution Resumes After RETURN Statement in Procedure	8-8
8-7	Execution Resumes After RETURN Statement in Anonymous Block	8-9
8-8	Nested Subprograms Invoke Each Other	8-9
8-9	Formal Parameters and Actual Parameters	8-11
8-10	Actual Parameter Inherits Only NOT NULL from Subtype	8-12
8-11	Actual Parameter and Return Value Inherit Only Range From Subtype	8-13
8-12	Function Implicitly Converts Formal Parameter to Constrained Subtype	8-13
8-13	Avoiding Implicit Conversion of Actual Parameters	8-14
8-14	Parameter Values Before, During, and After Procedure Invocation	8-17
8-15	OUT and IN OUT Parameter Values After Exception Handling	8-19
8-16	OUT Formal Parameter of Record Type with Non-NULL Default Value	8-19
8-17	Aliasing from Global Variable as Actual Parameter	8-21
8-18	Aliasing from Same Actual Parameter for Multiple Formal Parameters	8-22
8-19	Aliasing from Cursor Variable Subprogram Parameters	8-23
8-20	Procedure with Default Parameter Values	8-24
8-21	Function Provides Default Parameter Value	8-24
8-22	Adding Subprogram Parameter Without Changing Existing Invocations	8-25
8-23	Equivalent Invocations with Different Notations in Anonymous Block	8-27

8-24	Equivalent Invocations with Different Notations in SELECT Statements	8-28
8-25	Resolving PL/SQL Procedure Names	8-29
8-26	Overloaded Subprogram	8-31
8-27	Overload Error Causes Compile-Time Error	8-34
8-28	Overload Error Compiles Successfully	8-34
8-29	Invoking Subprogram in Causes Compile-Time Error	8-34
8-30	Correcting Overload Error in	8-34
8-31	Invoking Subprogram in	8-34
8-32	Package Specification Without Overload Errors	8-34
8-33	Improper Invocation of Properly Overloaded Subprogram	8-34
8-34	Implicit Conversion of Parameters Causes Overload Error	8-35
8-35	Recursive Function Returns n Factorial (n!)	8-36
8-36	Recursive Function Returns nth Fibonacci Number	8-36
8-37	Declaring and Defining Result-Cached Function	8-38
8-38	Result-Cached Function Returns Configuration Parameter Setting	8-41
8-39	Result-Cached Function Handles Session-Specific Settings	8-44
8-40	Result-Cached Function Handles Session-Specific Application Context	8-45
8-41	Caching One Name at a Time (Finer Granularity)	8-46
8-42	Caching Translated Names One Language at a Time (Coarser Granularity)	8-46
8-43	Database Link in a DR Unit	8-53
8-44	PL/SQL Anonymous Block Invokes External Procedure	8-54
8-45	PL/SQL Standalone Procedure Invokes External Procedure	8-54
9-1	Trigger Uses Conditional Predicates to Detect Triggering Statement	9-5
9-2	INSTEAD OF Trigger	9-6
9-3	INSTEAD OF Trigger on Nested Table Column of View	9-8
9-4	Compound Trigger Logs Changes to One Table in Another Table	9-13
9-5	Compound Trigger Avoids Mutating-Table Error	9-15
9-6	Foreign Key Trigger for Child Table	9-17
9-7	UPDATE and DELETE RESTRICT Trigger for Parent Table	9-18
9-8	UPDATE and DELETE SET NULL Trigger for Parent Table	9-19
9-9	DELETE CASCADE Trigger for Parent Table	9-20
9-10	UPDATE CASCADE Trigger for Parent Table	9-20
9-11	Trigger Checks Complex Constraints	9-22
9-12	Trigger Enforces Security Authorizations	9-23
9-13	Trigger Derives New Column Values	9-24
9-14	Trigger Logs Changes to EMPLOYEES.SALARY	9-29
9-15	Conditional Trigger Prints Salary Change Information	9-30

9-16	Trigger Modifies CLOB Columns	9-31
9-17	Trigger with REFERENCING Clause	9-32
9-18	Trigger References OBJECT_VALUE Pseudocolumn	9-33
9-19	BEFORE Statement Trigger on Sample Schema HR	9-35
9-20	AFTER Statement Trigger on Database	9-35
9-21	Trigger Monitors Logons	9-35
9-22	INSTEAD OF CREATE Trigger on Schema	9-36
9-23	Trigger Invokes Java Subprogram	9-36
9-24	Trigger Cannot Handle Exception if Remote Database is Unavailable	9-39
9-25	Workaround for	9-39
9-26	Trigger Causes Mutating-Table Error	9-43
9-27	Update Cascade	9-44
9-28	Viewing Information About Triggers	9-61
10-1	Simple Package Specification	10-5
10-2	Passing Associative Array to Standalone Subprogram	10-5
10-3	Matching Package Specification and Body	10-6
10-4	Creating SERIALLY_REUSABLE Packages	10-9
10-5	Effect of SERIALLY_REUSABLE Pragma	10-10
10-6	Cursor in SERIALLY_REUSABLE Package Open at Call Boundary	10-11
10-7	Separating Cursor Declaration and Definition in Package	10-13
10-8	ACCESSIBLE BY Clause	10-13
10-9	Creating emp_admin Package	10-15
11-1	Setting Value of PLSQL_WARNINGS Compilation Parameter	11-3
11-2	Displaying and Setting PLSQL_WARNINGS with DBMS_WARNING Subprograms	11-4
11-3	Single Exception Handler for Multiple Exceptions	11-8
11-4	Locator Variables for Statements that Share Exception Handler	11-9
11-5	Naming Internally Defined Exception	11-11
11-6	Anonymous Block Handles ZERO_DIVIDE	11-12
11-7	Anonymous Block Avoids ZERO_DIVIDE	11-13
11-8	Anonymous Block Handles ROWTYPE_MISMATCH	11-13
11-9	Redeclared Predefined Identifier	11-14
11-10	Declaring, Raising, and Handling User-Defined Exception	11-16
11-11	Explicitly Raising Predefined Exception	11-17
11-12	Reraising Exception	11-18
11-13	Raising User-Defined Exception with RAISE_APPLICATION_ERROR	11-19
11-14	Exception that Propagates Beyond Scope is Handled	11-21
11-15	Exception that Propagates Beyond Scope is Not Handled	11-22

11-16	Exception Raised in Declaration is Not Handled	11-23
11-17	Exception Raised in Declaration is Handled by Enclosing Block	11-23
11-18	Exception Raised in Exception Handler is Not Handled	11-24
11-19	Exception Raised in Exception Handler is Handled by Invoker	11-24
11-20	Exception Raised in Exception Handler is Handled by Enclosing Block	11-25
11-21	Exception Raised in Exception Handler is Not Handled	11-25
11-22	Exception Raised in Exception Handler is Handled by Enclosing Block	11-26
11-23	Displaying SQLCODE and SQLERRM Values	11-28
11-24	Exception Handler Runs and Execution Ends	11-29
11-25	Exception Handler Runs and Execution Continues	11-29
11-26	Retrying Transaction After Handling Exception	11-30
12-1	Specifying that Subprogram Is To Be Inlined	12-3
12-2	Specifying that Overloaded Subprogram Is To Be Inlined	12-3
12-3	Specifying that Subprogram Is Not To Be Inlined	12-4
12-4	PRAGMA INLINE ... 'NO' Overrides PRAGMA INLINE ... 'YES'	12-4
12-5	Nested Query Improves Performance	12-6
12-6	NOCOPY Subprogram Parameters	12-8
12-7	DELETE Statement in FOR LOOP Statement	12-14
12-8	DELETE Statement in FORALL Statement	12-14
12-9	Time Difference for INSERT Statement in FOR LOOP and FORALL Statements	12-14
12-10	FORALL Statement for Subset of Collection	12-15
12-11	FORALL Statements for Sparse Collection and Its Subsets	12-16
12-12	Handling FORALL Exceptions Immediately	12-20
12-13	Handling FORALL Exceptions After FORALL Statement Completes	12-22
12-14	Showing Number of Rows Affected by Each DELETE in FORALL	12-24
12-15	Showing Number of Rows Affected by Each INSERT SELECT in FORALL	12-25
12-16	Bulk-Selecting Two Database Columns into Two Nested Tables	12-27
12-17	Bulk-Selecting into Nested Table of Records	12-28
12-18	SELECT BULK COLLECT INTO Statement with Unexpected Results	12-29
12-19	Cursor Workaround for	12-30
12-20	Second Collection Workaround for	12-31
12-21	Limiting Bulk Selection with ROWNUM, SAMPLE, and FETCH FIRST	12-33
12-22	Bulk-Fetching into Two Nested Tables	12-34
12-23	Bulk-Fetching into Nested Table of Records	12-36
12-24	Limiting Bulk FETCH with LIMIT	12-37
12-25	Returning Deleted Rows in Two Nested Tables	12-38
12-26	DELETE with RETURN BULK COLLECT INTO in FORALL Statement	12-39

12-27	DELETE with RETURN BULK COLLECT INTO in FOR LOOP Statement	12-40
12-28	Anonymous Block Bulk-Binds Input Host Array	12-41
12-29	Creating and Invoking Pipelined Table Function	12-44
12-30	Pipelined Table Function Transforms Each Row to Two Rows	12-45
12-31	Fetching from Results of Pipelined Table Functions	12-47
12-32	Pipelined Table Function with Two Cursor Variable Parameters	12-48
12-33	Pipelined Table Function as Aggregate Function	12-49
12-34	Pipelined Table Function Does Not Handle NO_DATA_NEEDED	12-52
12-35	Pipelined Table Function Handles NO_DATA_NEEDED	12-52
12-36	Skip_col Polymorphic Table Function Example	12-58
12-37	To_doc Polymorphic Table Function Example	12-61
12-38	Implicit_echo Polymorphic Table Function Example	12-65
13-1	Restricting Access to Top-Level Procedures in the Same Schema	13-5
13-2	Restricting Access to a Unit Name of Any Kind	13-6
13-3	Restricting Access to a Stored Procedure	13-7
13-4	External Function Example	13-26
13-5	Marking a Single Basic Block as Infeasible to Test for Coverage	13-46
13-6	Marking a Line Range as Infeasible to Test for Coverage	13-46
13-7	Marking Entire Units or Individual Subprograms as Infeasible to Test for Coverage	13-47
13-8	Marking Internal Subprogram as Infeasible to Test for Coverage	13-47
13-9	Enabling the Deprecation Warnings	13-59
13-10	Deprecation of a PL/SQL Package	13-59
13-11	Deprecation of a PL/SQL Package with a Custom Warning	13-59
13-12	Deprecation of a PL/SQL Procedure	13-60
13-13	Deprecation of an Overloaded Procedure	13-60
13-14	Deprecation of a Constant and of an Exception	13-61
13-15	Using Conditional Compilation to Deprecate Entities in Some Database Releases	13-61
13-16	Deprecation of an Object Type	13-61
13-17	Deprecation of a Member Function in an Object Type Specification	13-62
13-18	Deprecation of Inherited Object Types	13-62
13-19	Deprecation Only Applies to Top Level Subprogram	13-64
13-20	Misplaced DEPRECATE Pragma	13-65
13-21	Mismatch of the Element Name and the DEPRECATE Pragma Argument	13-65
13-22	Budget : Using a SQL Macro in a Table Expression	13-159
13-23	Take: Using a Table Macro with a Polymorphic View	13-159
14-1	Recompiling a Function	14-4
14-2	Recompiling a Library	14-5

14-3	Recompiling a Package	14-7
14-4	Recompiling a Procedure	14-10
14-5	Disabling Triggers	14-12
14-6	Enabling Triggers	14-12
14-7	Adding a Member Function	14-21
14-8	Adding a Collection Attribute	14-22
14-9	Increasing the Number of Elements of a Collection Type	14-22
14-10	Increasing the Length of a Collection Type	14-22
14-11	Recompiling a Type	14-22
14-12	Recompiling a Type Specification	14-22
14-13	Evolving and Resetting an ADT	14-23
14-14	Creating a Function	14-28
14-15	Creating Aggregate Functions	14-29
14-16	Package Procedure in a Function	14-30
14-17	Creating a Library	14-34
14-18	Specifying an External Procedure Agent	14-34
14-19	Creating the Specification for the emp_mgmt Package	14-37
14-20	Creating the emp_mgmt Package Body	14-40
14-21	Creating a Procedure	14-44
14-22	Creating an External Procedure	14-45
14-23	ADT Examples	14-72
14-24	Creating a Subtype	14-73
14-25	Creating a Type Hierarchy	14-73
14-26	Creating a Varray Type	14-73
14-27	Creating a Nested Table Type	14-73
14-28	Creating a Nested Table Type Containing a Varray	14-74
14-29	Constructor Example	14-74
14-30	Creating a Member Method	14-74
14-31	Creating a Static Method	14-75
14-32	Dropping a Function	14-82
14-33	Dropping a Library	14-83
14-34	Dropping a Package	14-84
14-35	Dropping a Procedure	14-86
14-36	Dropping a Trigger	14-87
14-37	Dropping an ADT	14-89
14-38	Dropping an ADT Body	14-90
A-1	SQL File with Two Wrappable PL/SQL Units	A-3

A-2	Wrapping File with PL/SQL Wrapper Utility	A-4
A-3	Running Wrapped File and Viewing Wrapped PL/SQL Units	A-5
A-4	Creating Wrapped Package Body with CREATE_WRAPPED Procedure	A-9
A-5	Viewing Package with Wrapped Body and Invoking Package Procedure	A-10
B-1	Qualified Names	B-2
B-2	Variable Name Interpreted as Column Name Causes Unintended Result	B-3
B-3	Fixing with Different Variable Name	B-4
B-4	Fixing with Block Label	B-4
B-5	Subprogram Name for Name Resolution	B-4
B-6	Inner Capture of Column Reference	B-7
B-7	Inner Capture of Attribute Reference	B-8
B-8	Qualifying ADT Attribute References	B-9
B-9	Qualifying References to Row Expressions	B-10

List of Figures

1-1	PL/SQL Engine	1-11
5-1	Varray of Maximum Size 10 with 7 Elements	5-10
5-2	Array and Nested Table	5-16
6-1	Transaction Control Flow	6-56
8-1	How PL/SQL Compiler Resolves Invocations	8-29
11-1	Exception Does Not Propagate	11-20
11-2	Exception Propagates from Inner Block to Outer Block	11-20
11-3	PL/SQL Returns Unhandled Exception Error to Host Environment	11-21

List of Tables

1-1	PL/SQL I/O-Processing Packages	1-6
1-2	PL/SQL Compilation Parameters	1-12
2-1	Punctuation Characters in Every Database Character Set	2-2
2-2	PL/SQL Delimiters	2-5
2-3	Operator Precedence	2-30
2-4	Logical Truth Table	2-32
2-5	Relational Operators	2-38
2-6	Operators Allowed in Static Expressions	2-49
3-1	Data Types with Different Maximum Sizes in PL/SQL and SQL	3-2
3-2	Predefined PL/SQL BINARY_FLOAT and BINARY_DOUBLE Constants	3-3
3-3	Predefined Subtypes of PLS_INTEGER Data Type	3-11
5-1	PL/SQL Collection Types	5-2
5-2	Collection Methods	5-29
8-1	PL/SQL Subprogram Parameter Modes	8-15
8-2	PL/SQL Subprogram Parameter Modes Characteristics	8-15
8-3	PL/SQL Actual Parameter Notations	8-26
8-4	Finer and Coarser Caching Granularity	8-46
9-1	Conditional Predicates	9-5
9-2	Compound Trigger Timing-Point Sections	9-11
9-3	Constraints and Triggers for Ensuring Referential Integrity	9-16
9-4	OLD and NEW Pseudorecord Field Values	9-29
9-5	System-Defined Event Attributes	9-51
9-6	Database Event Triggers	9-55
9-7	Client Event Triggers	9-56
11-1	Compile-Time Warning Categories	11-2
11-2	Exception Categories	11-7
11-3	PL/SQL Predefined Exceptions	11-11
12-1	Profiling and Tracing Tools Summary	12-68
C-1	PL/SQL Compiler Limits	C-1
D-1	PL/SQL Reserved Words	D-1
D-2	PL/SQL Keywords	D-2

Preface

Oracle Database PL/SQL Language Reference describes and explains how to use PL/SQL, the Oracle procedural extension of SQL.

Topics

- [Audience](#)
- [Documentation Accessibility](#)
- [Related Documents](#)
- [Conventions](#)
- [Syntax Descriptions](#)

Audience

Oracle Database PL/SQL Language Reference is intended for anyone who is developing PL/SQL-based applications for either an Oracle Database or an Oracle TimesTen In-Memory Database, including:

- Programmers
- Systems analysts
- Project managers
- Database administrators

To use this document effectively, you need a working knowledge of:

- Oracle Database
- Structured Query Language (SQL)
- Basic programming concepts such as `IF-THEN` statements, loops, procedures, and functions

Documentation Accessibility

For information about Oracle's commitment to accessibility, visit the Oracle Accessibility Program website at <http://www.oracle.com/pls/topic/lookup?ctx=acc&id=docacc>.

Access to Oracle Support

Oracle customers that have purchased support have access to electronic support through My Oracle Support. For information, visit <http://www.oracle.com/pls/topic/lookup?ctx=acc&id=info> or visit <http://www.oracle.com/pls/topic/lookup?ctx=acc&id=trs> if you are hearing impaired.

Related Documents

For more information, see these documents in the Oracle Database documentation set:

- *Oracle Database SQL Language Reference*
 - *Oracle Database PL/SQL Packages and Types Reference*
 - *Oracle Database JSON Developer's Guide*
 - *Oracle Database SODA for PL/SQL Developer's Guide*
 - *Oracle Database Development Guide*
 - *Oracle Database Administrator's Guide*
 - *Oracle Database SecureFiles and Large Objects Developer's Guide*
 - *Oracle Database Object-Relational Developer's Guide*
 - *Oracle Database Concepts*
- Oracle Database Sample Schemas*



See Also:

<http://www.oracle.com/technetwork/database/features/plsql/index.html>

Conventions

This document uses these text conventions:

Convention	Meaning
boldface	Boldface type indicates graphical user interface elements associated with an action, or terms defined in text or the glossary.
<i>italic</i>	Italic type indicates book titles, emphasis, or placeholder variables for which you supply particular values.
monospace	Monospace type indicates commands within a paragraph, URLs, code in examples, text that appears on the screen, or text that you enter.
{A B C}	Choose either A, B, or C.

Also:

- `*_view` means all static data dictionary views whose names end with `view`. For example, `*_ERRORS` means `ALL_ERRORS`, `DBA_ERRORS`, and `USER_ERRORS`. For more information about any static data dictionary view, or about static dictionary views in general, see *Oracle Database Reference*.
- Table names not qualified with schema names are in the sample schema `HR`. For information about the sample schemas, see *Oracle Database Sample Schemas*.

Syntax Descriptions

Syntax descriptions are provided in this book for various SQL, PL/SQL, or other command-line constructs in graphic form or Backus Naur Form (BNF). See *Oracle Database SQL Language Reference* for information about how to interpret these descriptions.

Changes in This Release for Oracle Database PL/SQL Language Reference

Changes to *Oracle Database PL/SQL Language Reference* are described for each release.

This preface contains:

- [Changes in Release 19c for Oracle Database PL/SQL Language Reference](#)
- [Changes in Release 18c for Oracle Database PL/SQL Language Reference](#)

Changes in Oracle Database Release 19c

Starting from Oracle Database 19c, if a polymorphic table function and its implementation methods are defined in the same package, then the `USING` clause is optional.

See Also:

- [PIPELINED Clause](#) for more information on polymorphic table function, syntax and semantics

SQL Macros

You can create SQL macros (SQM) to factor out common SQL expressions and statements into reusable, parameterized constructs that can be used in other SQL statements.

Starting with Oracle Database release 19c, version 19.7, SQL table macros are supported. SQL table macros are expressions, typically used in a `FROM` clause, to act as a sort of polymorphic (parameterized) views.

SQL table macros increase developer productivity, simplify collaborative development, and improve code quality.

See Also:

- ["CREATE FUNCTION Statement"](#) for more information about the syntax and semantics
- ["SQL_MACRO Clause"](#) syntax and semantics

Changes in Oracle Database Release 18c

For Oracle Database 18c, Oracle Database PL/SQL Language Reference documents these new features.

New Features

Non-Persistence Support for Object Types

This feature enables you to mark abstract data types used in programs for processing only, for storage only, or for mixed use.

Instances of non-persistable types cannot persist on disk.



See Also:

- `CREATE TYPE` statement [\[NOT\] PERSISTABLE](#) clause for more information about the syntax and semantics

Polymorphic Table Functions

A polymorphic table function (PTF) is a new type of table function whose return type is determined by the arguments passed into the PTF.

A table function is a function that returns a collection of rows and that can be called from the `FROM` clause of a SQL query block.

The new polymorphic table function (PTF) provides an efficient and scalable framework to extend the analytical capabilities of the Oracle Database. A query writer is able to call these functions without knowing the details of the implementation of the PTF and the PTF doesn't need to know about the details or how the function is being executed (e.g. in serial or parallel) or whether the input rows are partitioned or ordered.

Therefore, a PTF is useful when SQL developers and database administrators want to provide generic extensions which work for arbitrary input tables or queries.

See [Overview of Polymorphic Table Functions](#) for more information.

Qualified Expressions

Aggregates and their necessary adjunct, qualified expressions, improve program clarity and programmer productivity.

Through Oracle Database 12c release 2, it was possible to supply the value of a non-scalar datatype with an expression, for example by using the type constructor for a nested table. Starting with Oracle Database Release 18c, any PL/SQL value can be provided by an expression (for example for a record or for an associative array) like a constructor provides an abstract datatype value. In PL/SQL, we use the terms "qualified expression" and "aggregate" rather than the SQL term "type constructor", but the functionality is the same.

See [Qualified Expressions Overview](#) and [qualified_expression ::=](#) for more information about the syntax and semantics.

Deprecated Features

The following features are deprecated in this release, and may be desupported in a future release.

The command `ALTER TYPE ... INVALIDATE` is deprecated. Use the `CASCADE` clause instead.

The `REPLACE` clause of `ALTER TYPE` is deprecated. Use the `alter_method_spec` clause instead. Alternatively, you can recreate the type using the `CREATE OR REPLACE TYPE` statement.

For the syntax and semantics, see [ALTER TYPE Statement](#)

Starting with Oracle Database 12c release 1 (12.1), the compilation parameter `PLSQL_DEBUG` is deprecated.

To compile PL/SQL units for debugging, specify `PLSQL_OPTIMIZE_LEVEL=1`.

For information about compilation parameters, see [PL/SQL Units and Compilation Parameters](#).

Desupported Features

No features in PL/SQL Language Reference have been desupported for 19c.

Note:

Oracle Database Advanced Queuing continues to be enhanced and is independent of Oracle Streams, which is desupported in Oracle Database 19c.

See Also:

- *Oracle Database Upgrade Guide* for more information about desupported features in Oracle Database 19c

1

Overview of PL/SQL

PL/SQL, the Oracle procedural extension of SQL, is a portable, high-performance transaction-processing language. This overview explains its advantages and briefly describes its main features and its architecture.

Topics

- [Advantages of PL/SQL](#)
- [Main Features of PL/SQL](#)
- [Architecture of PL/SQL](#)

1.1 Advantages of PL/SQL

PL/SQL offers several advantages over other programming languages.

PL/SQL has these advantages:

- [Tight Integration with SQL](#)
- [High Performance](#)
- [High Productivity](#)
- [Portability](#)
- [Scalability](#)
- [Manageability](#)
- [Support for Object-Oriented Programming](#)

1.1.1 Tight Integration with SQL

PL/SQL is tightly integrated with SQL, the most widely used database manipulation language.

For example:

- PL/SQL lets you use all SQL data manipulation, cursor control, and transaction control statements, and all SQL functions, operators, and pseudocolumns.
- PL/SQL fully supports SQL data types.

You need not convert between PL/SQL and SQL data types. For example, if your PL/SQL program retrieves a value from a column of the SQL type `VARCHAR2`, it can store that value in a PL/SQL variable of the type `VARCHAR2`.

You can give a PL/SQL data item the data type of a column or row of a database table without explicitly specifying that data type (see "[Using the %TYPE Attribute](#)" and "[Using the %ROWTYPE Attribute](#)").

- PL/SQL lets you run a SQL query and process the rows of the result set one at a time (see "[Processing a Query Result Set One Row at a Time](#)").

- PL/SQL functions can be declared and defined in the `WITH` clauses of SQL `SELECT` statements (see *Oracle Database SQL Language Reference*).

PL/SQL supports both static and dynamic SQL. **Static SQL** is SQL whose full text is known at compile time. **Dynamic SQL** is SQL whose full text is not known until run time. Dynamic SQL lets you make your applications more flexible and versatile. For more information, see [PL/SQL Static SQL](#) and [PL/SQL Dynamic SQL](#).

1.1.2 High Performance

PL/SQL lets you send a block of statements to the database, significantly reducing traffic between the application and the database.

Bind Variables

When you embed a SQL `INSERT`, `UPDATE`, `DELETE`, `MERGE`, or `SELECT` statement directly in your PL/SQL code, the PL/SQL compiler turns the variables in the `WHERE` and `VALUES` clauses into bind variables (for details, see "[Resolution of Names in Static SQL Statements](#)"). Oracle Database can reuse these SQL statements each time the same code runs, which improves performance.

PL/SQL does not create bind variables automatically when you use dynamic SQL, but you can use them with dynamic SQL by specifying them explicitly (for details, see "[EXECUTE IMMEDIATE Statement](#)").

Subprograms

PL/SQL subprograms are stored in executable form, which can be invoked repeatedly. Because stored subprograms run in the database server, a single invocation over the network can start a large job. This division of work reduces network traffic and improves response times. Stored subprograms are cached and shared among users, which lowers memory requirements and invocation overhead. For more information about subprograms, see "[Subprograms](#)".

Optimizer

The PL/SQL compiler has an optimizer that can rearrange code for better performance. For more information about the optimizer, see "[PL/SQL Optimizer](#)".

1.1.3 High Productivity

PL/SQL has many features that save designing and debugging time, and it is the same in all environments.

PL/SQL lets you write compact code for manipulating data. Just as a scripting language like PERL can read, transform, and write data in files, PL/SQL can query, transform, and update data in a database.

If you learn to use PL/SQL with one Oracle tool, you can transfer your knowledge to other Oracle tools. For an overview of PL/SQL features, see "[Main Features of PL/SQL](#)".

1.1.4 Portability

PL/SQL is a portable and standard language for Oracle development.

You can run PL/SQL applications on any operating system and platform where Oracle Database runs.

1.1.5 Scalability

PL/SQL stored subprograms increase scalability by centralizing application processing on the database server.

The shared memory facilities of the shared server let Oracle Database support thousands of concurrent users on a single node. For more information about subprograms, see "[Subprograms](#)".

For further scalability, you can use Oracle Connection Manager to multiplex network connections. For information about Oracle Connection Manager, see [Oracle Database Net Services Reference](#).

1.1.6 Manageability

PL/SQL stored subprograms increase manageability because you can maintain only one copy of a subprogram, on the database server, rather than one copy on each client system.

Any number of applications can use the subprograms, and you can change the subprograms without affecting the applications that invoke them. For more information about subprograms, see "[Subprograms](#)".

1.1.7 Support for Object-Oriented Programming

PL/SQL allows defining object types that can be used in object-oriented designs.

PL/SQL supports object-oriented programming with "[Abstract Data Types](#)".

1.2 Main Features of PL/SQL

PL/SQL combines the data-manipulating power of SQL with the processing power of procedural languages.

When you can solve a problem with SQL, you can issue SQL statements from your PL/SQL program, without learning new APIs.

Like other procedural programming languages, PL/SQL lets you declare constants and variables, control program flow, define subprograms, and trap runtime errors.

You can break complex problems into easily understandable subprograms, which you can reuse in multiple applications.

Topics

- [Error Handling](#)
- [Blocks](#)
- [Variables and Constants](#)
- [Subprograms](#)
- [Packages](#)
- [Triggers](#)

- [Input and Output](#)
- [Data Abstraction](#)
- [Control Statements](#)
- [Conditional Compilation](#)
- [Processing a Query Result Set One Row at a Time](#)

1.2.1 Error Handling

PL/SQL makes it easy to detect and handle errors.

When an error occurs, PL/SQL raises an exception. Normal execution stops and control transfers to the exception-handling part of the PL/SQL block. You do not have to check every operation to ensure that it succeeded, as in a C program.

For more information, see [PL/SQL Error Handling](#).

1.2.2 Blocks

The basic unit of a PL/SQL source program is the **block**, which groups related declarations and statements.

A PL/SQL block is defined by the keywords `DECLARE`, `BEGIN`, `EXCEPTION`, and `END`. These keywords divide the block into a declarative part, an executable part, and an exception-handling part. Only the executable part is required. A block can have a label.

Declarations are local to the block and cease to exist when the block completes execution, helping to avoid cluttered namespaces for variables and subprograms.

Blocks can be nested: Because a block is an executable statement, it can appear in another block wherever an executable statement is allowed.

You can submit a block to an interactive tool (such as SQL*Plus or Enterprise Manager) or embed it in an Oracle Precompiler or OCI program. The interactive tool or program runs the block one time. The block is not stored in the database, and for that reason, it is called an **anonymous block** (even if it has a label).

An anonymous block is compiled each time it is loaded into memory, and its compilation has three stages:

1. Syntax checking: PL/SQL syntax is checked, and a parse tree is generated.
2. Semantic checking: Type checking and further processing on the parse tree.
3. Code generation

Note:

An anonymous block is a SQL statement.

For syntax details, see "[Block](#)".

Example 1-1 PL/SQL Block Structure

This example shows the basic structure of a PL/SQL block.

```
<< label >> (optional)
DECLARE    -- Declarative part (optional)
    -- Declarations of local types, variables, & subprograms

BEGIN      -- Executable part (required)
    -- Statements (which can use items declared in declarative part)

[EXCEPTION -- Exception-handling part (optional)
    -- Exception handlers for exceptions (errors) raised in executable part]
END;
```

1.2.3 Variables and Constants

PL/SQL lets you declare variables and constants, and then use them wherever you can use an expression.

As the program runs, the values of variables can change, but the values of constants cannot.

For more information, see "[Declarations](#)" and "[Assigning Values to Variables](#)".

1.2.4 Subprograms

A PL/SQL **subprogram** is a named PL/SQL block that can be invoked repeatedly.

If the subprogram has parameters, their values can differ for each invocation. PL/SQL has two types of subprograms, procedures and functions. A function returns a result.

For more information about PL/SQL subprograms, see [PL/SQL Subprograms](#).

PL/SQL also lets you invoke external programs written in other languages.

For more information, see "[External Subprograms](#)".

1.2.5 Packages

A **package** is a schema object that groups logically related PL/SQL types, variables, constants, subprograms, cursors, and exceptions.

A package is compiled and stored in the database, where many applications can share its contents. You can think of a package as an application.

You can write your own packages—for details, see [PL/SQL Packages](#). You can also use the many product-specific packages that Oracle Database supplies. For information about these, see *Oracle Database PL/SQL Packages and Types Reference*.

1.2.6 Triggers

A **trigger** is a named PL/SQL unit that is stored in the database and run in response to an event that occurs in the database.

You can specify the event, whether the trigger fires before or after the event, and whether the trigger runs for each event or for each row affected by the event. For example, you can create a trigger that runs every time an `INSERT` statement affects the `EMPLOYEES` table.

For more information about triggers, see [PL/SQL Triggers](#).

1.2.7 Input and Output

Most PL/SQL input and output (I/O) is done with SQL statements that store data in database tables or query those tables. All other PL/SQL I/O is done with PL/SQL packages that Oracle Database supplies.

Table 1-1 PL/SQL I/O-Processing Packages

Package	Description	More Information
DBMS_OUTPUT	Lets PL/SQL blocks, subprograms, packages, and triggers display output. Especially useful for displaying PL/SQL debugging information.	<i>Oracle Database PL/SQL Packages and Types Reference</i>
HTF	Has hypertext functions that generate HTML tags (for example, the <code>HTF.ANCHOR</code> function generates the HTML anchor tag <code><A></code>).	<i>Oracle Database PL/SQL Packages and Types Reference</i>
HTP	Has hypertext procedures that generate HTML tags.	<i>Oracle Database PL/SQL Packages and Types Reference</i>
DBMS_PIPE	Lets two or more sessions in the same instance communicate.	<i>Oracle Database PL/SQL Packages and Types Reference</i>
UTL_FILE	Lets PL/SQL programs read and write operating system files.	<i>Oracle Database PL/SQL Packages and Types Reference</i>
UTL_HTTP	Lets PL/SQL programs make Hypertext Transfer Protocol (HTTP) callouts, and access data on the Internet over HTTP.	<i>Oracle Database PL/SQL Packages and Types Reference</i>
UTL_SMTP	Sends electronic mails (emails) over Simple Mail Transfer Protocol (SMTP) as specified by RFC821.	<i>Oracle Database PL/SQL Packages and Types Reference</i>

To display output passed to `DBMS_OUTPUT`, you need another program, such as SQL*Plus. To see `DBMS_OUTPUT` output with SQL*Plus, you must first issue the SQL*Plus command `SET SERVEROUTPUT ON`.

Some subprograms in the packages in [Table 1-1](#) can both accept input and display output, but they cannot accept data directly from the keyboard. To accept data directly from the keyboard, use the SQL*Plus commands `PROMPT` and `ACCEPT`.

 **See Also:**

- *SQL*Plus User's Guide and Reference* for information about the SQL*Plus command `SET SERVEROUTPUT ON`
- *SQL*Plus User's Guide and Reference* for information about the SQL*Plus command `PROMPT`
- *SQL*Plus User's Guide and Reference* for information about the SQL*Plus command `ACCEPT`
- *Oracle Database SQL Language Reference* for information about SQL statements

1.2.8 Data Abstraction

Data abstraction lets you work with the essential properties of data without being too involved with details.

You can design a data structure first, and then design algorithms that manipulate it.

Topics

- [Cursors](#)
- [Composite Variables](#)
- [Using the %ROWTYPE Attribute](#)
- [Using the %TYPE Attribute](#)
- [Abstract Data Types](#)

1.2.8.1 Cursors

A **cursor** is a pointer to a private SQL area that stores information about processing a specific SQL statement or PL/SQL `SELECT INTO` statement.

You can use the cursor to retrieve the rows of the result set one at a time. You can use cursor attributes to get information about the state of the cursor—for example, how many rows the statement has affected so far.

For more information about cursors, see "[Cursors Overview](#)".

1.2.8.2 Composite Variables

A **composite variable** has internal components, which you can access individually.

You can pass entire composite variables to subprograms as parameters. PL/SQL has two kinds of composite variables, collections and records.

In a **collection**, the internal components are always of the same data type, and are called **elements**. You access each element by its unique index. Lists and arrays are classic examples of collections.

In a **record**, the internal components can be of different data types, and are called **fields**. You access each field by its name. A record variable can hold a table row, or some columns from a table row.

For more information about composite variables, see [PL/SQL Collections and Records](#).

1.2.8.3 Using the %ROWTYPE Attribute

The `%ROWTYPE` attribute lets you declare a record that represents either a full or partial row of a database table or view.

For every column of the full or partial row, the record has a field with the same name and data type. If the structure of the row changes, then the structure of the record changes accordingly.

For more information about `%ROWTYPE` syntax and semantics, see "[%ROWTYPE Attribute](#)". For more details about its usage, see "[Declaring Items using the %ROWTYPE Attribute](#)".

1.2.8.4 Using the %TYPE Attribute

The `%TYPE` attribute lets you declare a data item of the same data type as a previously declared variable or column (without knowing what that type is).

If the declaration of the referenced item changes, then the declaration of the referencing item changes accordingly. The `%TYPE` attribute is particularly useful when declaring variables to hold database values. For more information about `%TYPE` syntax and semantics, see "[%TYPE Attribute](#)". For more details about its usage, see "[Declaring Items using the %TYPE Attribute](#)".

1.2.8.5 Abstract Data Types

An **Abstract Data Type (ADT)** consists of a data structure and subprograms that manipulate the data.

The variables that form the data structure are called **attributes**. The subprograms that manipulate the attributes are called **methods**.

ADTs are stored in the database. Instances of ADTs can be stored in tables and used as PL/SQL variables.

ADTs let you reduce complexity by separating a large system into logical components, which you can reuse.

In the static data dictionary view `*_OBJECTS`, the `OBJECT_TYPE` of an ADT is `TYPE`. In the static data dictionary view `*_TYPES`, the `TYPECODE` of an ADT is `OBJECT`.

For more information about ADTs, see "[CREATE TYPE Statement](#)".



Note:

ADTs are also called **user-defined types** and **object types**.

 **See Also:**

Oracle Database Object-Relational Developer's Guide for information about ADTs (which it calls *object types*)

1.2.9 Control Statements

Control statements are the most important PL/SQL extension to SQL.

PL/SQL has three categories of control statements:

- **Conditional selection statements**, which let you run different statements for different data values.
For more information, see "[Conditional Selection Statements](#)".
- **Loop statements**, which let you repeat the same statements with a series of different data values.
For more information, see "[LOOP Statements](#)".
- **Sequential control statements**, which allow you to go to a specified, labeled statement, or to do nothing.
For more information, see "[Sequential Control Statements](#)".

1.2.10 Conditional Compilation

Conditional compilation lets you customize the functionality in a PL/SQL application without removing source text.

For example, you can:

- Use new features with the latest database release, and disable them when running the application in an older database release.
- Activate debugging or tracing statements in the development environment, and hide them when running the application at a production site.

For more information, see "[Conditional Compilation](#)".

1.2.11 Processing a Query Result Set One Row at a Time

PL/SQL lets you issue a SQL query and process the rows of the result set one at a time.

You can use a basic loop, or you can control the process precisely by using individual statements to run the query, retrieve the results, and finish processing.

Example 1-2 Processing Query Result Rows One at a Time

This example uses a basic loop.

```
BEGIN
  FOR someone IN (
    SELECT * FROM employees
    WHERE employee_id < 120
    ORDER BY employee_id
  )
```



```
LOOP
  DBMS_OUTPUT.PUT_LINE('First name = ' || someone.first_name ||
                        ', Last name = ' || someone.last_name);
END LOOP;
END;
/
```

Result:

```
First name = Steven, Last name = King
First name = Neena, Last name = Kochhar
First name = Lex, Last name = De Haan
First name = Alexander, Last name = Hunold
First name = Bruce, Last name = Ernst
First name = David, Last name = Austin
First name = Valli, Last name = Pataballa
First name = Diana, Last name = Lorentz
First name = Nancy, Last name = Greenberg
First name = Daniel, Last name = Faviet
First name = John, Last name = Chen
First name = Ismael, Last name = Sciarra
First name = Jose Manuel, Last name = Urman
First name = Luis, Last name = Popp
First name = Den, Last name = Raphaely
First name = Alexander, Last name = Khoo
First name = Shelli, Last name = Baida
First name = Sigal, Last name = Tobias
First name = Guy, Last name = Himuro
First name = Karen, Last name = Colmenares
```

1.3 Architecture of PL/SQL

Basic understanding of the PL/SQL architecture is beneficial to PL/SQL programmers.

Topics

- [PL/SQL Engine](#)
- [PL/SQL Units and Compilation Parameters](#)

1.3.1 PL/SQL Engine

The PL/SQL compilation and runtime system is an engine that compiles and runs PL/SQL units.

The engine can be installed in the database or in an application development tool, such as Oracle Forms.

In either environment, the PL/SQL engine accepts as input any valid PL/SQL unit. The engine runs procedural statements, but sends SQL statements to the SQL engine in the database, as shown in [Figure 1-1](#).

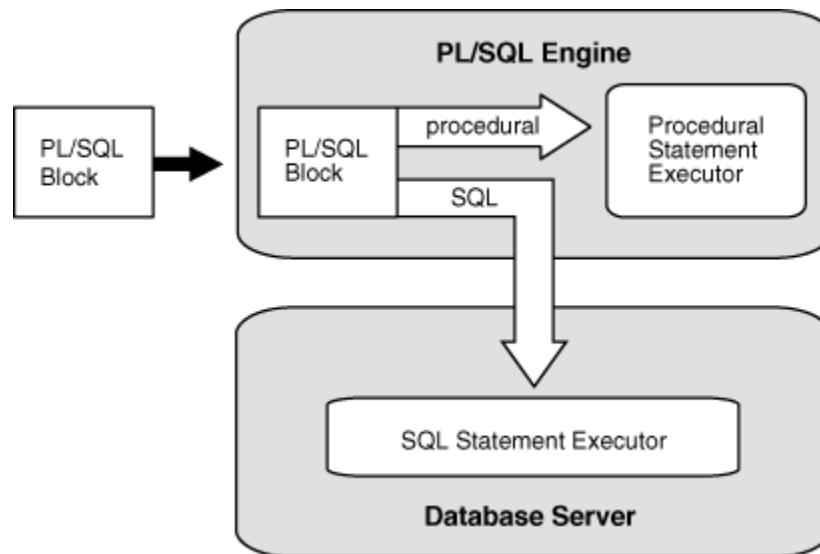
Figure 1-1 PL/SQL Engine

Typically, the database processes PL/SQL units.

When an application development tool processes PL/SQL units, it passes them to its local PL/SQL engine. If a PL/SQL unit contains no SQL statements, the local engine processes the entire PL/SQL unit. This is useful if the application development tool can benefit from conditional and iterative control.

For example, Oracle Forms applications frequently use SQL statements to test the values of field entries and do simple computations. By using PL/SQL instead of SQL, these applications can avoid calls to the database.

1.3.2 PL/SQL Units and Compilation Parameters

PL/SQL units are affected by PL/SQL compilation parameters (a category of database initialization parameters). Different PL/SQL units—for example, a package specification and its body—can have different compilation parameter settings.

A PL/SQL unit is one of these:

- PL/SQL anonymous block
- FUNCTION
- LIBRARY
- PACKAGE
- PACKAGE BODY
- PROCEDURE
- TRIGGER
- TYPE
- TYPE BODY

[Table 1-2](#) summarizes the PL/SQL compilation parameters. To display the values of these parameters for specified or all PL/SQL units, query the static data dictionary view `ALL_PLSQL_OBJECT_SETTINGS`. For information about this view, see *Oracle Database Reference*.

Table 1-2 PL/SQL Compilation Parameters

Parameter	Description
<code>PLSCOPE_SETTINGS</code>	Controls the compile-time collection, cross-reference, and storage of PL/SQL source text identifier data. Used by the PL/Scope tool (see <i>Oracle Database Development Guide</i>). For more information about <code>PLSCOPE_SETTINGS</code> , see <i>Oracle Database Reference</i> .
<code>PLSQL_CCFLAGS</code>	Lets you control conditional compilation of each PL/SQL unit independently. For more information about <code>PLSQL_CCFLAGS</code> , see " How Conditional Compilation Works " and <i>Oracle Database Reference</i> .
<code>PLSQL_CODE_TYPE</code>	Specifies the compilation mode for PL/SQL units— <code>INTERPRETED</code> (the default) or <code>NATIVE</code> . For information about which mode to use, see " Determining Whether to Use PL/SQL Native Compilation ". If the optimization level (set by <code>PLSQL_OPTIMIZE_LEVEL</code>) is less than 2: <ul style="list-style-type: none"> The compiler generates interpreted code, regardless of <code>PLSQL_CODE_TYPE</code>. If you specify <code>NATIVE</code>, the compiler warns you that <code>NATIVE</code> was ignored. For more information about <code>PLSQL_CODE_TYPE</code> , see <i>Oracle Database Reference</i> .
<code>PLSQL_OPTIMIZE_LEVEL</code>	Specifies the optimization level at which to compile PL/SQL units (the higher the level, the more optimizations the compiler tries to make). <code>PLSQL_OPTIMIZE_LEVEL=1</code> instructs the PL/SQL compiler to generate and store code for use by the PL/SQL debugger. For more information about <code>PLSQL_OPTIMIZE_LEVEL</code> , see " PL/SQL Optimizer " and <i>Oracle Database Reference</i> .
<code>PLSQL_WARNINGS</code>	Enables or disables the reporting of warning messages by the PL/SQL compiler, and specifies which warning messages to show as errors. For more information about <code>PLSQL_WARNINGS</code> , see " Compile-Time Warnings " and <i>Oracle Database Reference</i> .
<code>NLS_LENGTH_SEMANTICS</code>	Lets you create <code>CHAR</code> and <code>VARCHAR2</code> columns using either byte-length or character-length semantics. For more information about byte and character length semantics, see " CHAR and VARCHAR2 Variables ". For more information about <code>NLS_LENGTH_SEMANTICS</code> , see <i>Oracle Database Reference</i> .

Table 1-2 (Cont.) PL/SQL Compilation Parameters

Parameter	Description
PERMIT_92_WRAP_FORMAT	<p>Specifies whether the 12.1 PL/SQL compiler can use wrapped packages that were compiled with the 9.2 PL/SQL compiler. The default value is TRUE.</p> <p>For more information about wrapped packages, see PL/SQL Source Text Wrapping.</p> <p>For more information about PERMIT_92_WRAP_FORMAT, see <i>Oracle Database Reference</i>.</p>

 **Note:**

The compilation parameter `PLSQL_DEBUG`, which specifies whether to compile PL/SQL units for debugging, is deprecated. To compile PL/SQL units for debugging, specify `PLSQL_OPTIMIZE_LEVEL=1`.

The compile-time values of the parameters in [Table 1-2](#) are stored with the metadata of each stored PL/SQL unit, which means that you can reuse those values when you explicitly recompile the unit. (A **stored PL/SQL unit** is created with one of the "[CREATE \[OR REPLACE \] Statements](#)". An anonymous block is not a stored PL/SQL unit.)

To explicitly recompile a stored PL/SQL unit and reuse its parameter values, you must use an `ALTER` statement with both the `COMPILE` clause and the `REUSE SETTINGS` clause. All `ALTER` statements have this clause. For a list of `ALTER` statements, see "[ALTER Statements](#)".

1.4 Protecting Sensitive Information in PL/SQL

Data security should be a top priority during any application development. There are several ways you can mitigate the risk of vulnerabilities while using PL/SQL.

Be aware that the content of a PL/SQL block may be written in its entirety in such places as audit logs and trace files. Similarly, stored procedure code can be accessed through dictionary views, such as `USER_SOURCE`. For this reason, it is strongly recommended that you never include any sensitive information in a literal seen in PL/SQL code.

Bind variables can be used to help protect against SQL injection attacks, however, bind values can be visible in places such as trace files, audit, and `V$SQL` and related views. Access should be strictly managed to ensure that only those who require it have privileges to view this particularly sensitive information. For more information about using bind variables, see "[Bind Variables](#)".

2

PL/SQL Language Fundamentals

The PL/SQL language fundamental components are explained.

- [Character Sets](#)
- [Lexical Units](#)
- [Declarations](#)
- [References to Identifiers](#)
- [Scope and Visibility of Identifiers](#)
- [Assigning Values to Variables](#)
- [Expressions](#)
- [Error-Reporting Functions](#)
- [Conditional Compilation](#)

2.1 Character Sets

Any character data to be processed by PL/SQL or stored in a database must be represented as a sequence of bytes. The byte representation of a single character is called a **character code**. A set of character codes is called a **character set**.

Every Oracle database supports a database character set and a national character set. PL/SQL also supports these character sets. This document explains how PL/SQL uses the database character set and national character set.

Topics

- [Database Character Set](#)
- [National Character Set](#)
- [About Data-Bound Collation](#)



See Also:

Oracle Database Globalization Support Guide for general information about character sets

2.1.1 Database Character Set

PL/SQL uses the **database character set** to represent:

- Stored source text of PL/SQL units

For information about PL/SQL units, see "[PL/SQL Units and Compilation Parameters](#)".

- Character values of data types CHAR, VARCHAR2, CLOB, and LONG

For information about these data types, see "[SQL Data Types](#)".

The database character set can be either single-byte, mapping each supported character to one particular byte, or multibyte-varying-width, mapping each supported character to a sequence of one, two, three, or four bytes. The maximum number of bytes in a character code depends on the particular character set.

Every database character set includes these basic characters:

- **Latin letters:** A through Z and a through z
- **Decimal digits:** 0 through 9
- **Punctuation characters** in [Table 2-1](#)
- **Whitespace characters:** *space, tab, new line, and carriage return*

PL/SQL source text that uses only the basic characters can be stored and compiled in any database. PL/SQL source text that uses nonbasic characters can be stored and compiled only in databases whose database character sets support those nonbasic characters.

Table 2-1 Punctuation Characters in Every Database Character Set

Symbol	Name
(Left parenthesis
)	Right parenthesis
<	Left angle bracket
>	Right angle bracket
+	Plus sign
-	Hyphen <i>or</i> minus sign
*	Asterisk
/	Slash
=	Equal sign
,	Comma
;	Semicolon
:	Colon
.	Period
!	Exclamation point
?	Question mark
'	Apostrophe <i>or</i> single quotation mark
"	Quotation mark <i>or</i> double quotation mark
@	At sign
%	Percent sign
#	Number sign
\$	Dollar sign
_	Underscore

Table 2-1 (Cont.) Punctuation Characters in Every Database Character Set

Symbol	Name
	Vertical bar

 **See Also:**

Oracle Database Globalization Support Guide for more information about the database character set

2.1.2 National Character Set

PL/SQL uses the **national character set** to represent character values of data types `NCHAR`, `NVARCHAR2` and `NCLOB`.

 **See Also:**

- "[SQL Data Types](#)" for information about these data types
- *Oracle Database Globalization Support Guide* for more information about the national character set

2.1.3 About Data-Bound Collation

Collation (also called sort ordering) is a set of rules that determines if a character string equals, precedes, or follows another string when the two strings are compared and sorted.

Different collations correspond to rules of different spoken languages. Collation-sensitive operations are operations that compare text and need a collation to control the comparison rules. The equality operator and the built-in function `INSTR` are examples of collation-sensitive operations.

Starting with Oracle Database 12c release 2 (12.2), a new architecture provides control of the collation to be applied to operations on character data. In the new architecture, collation becomes an attribute of character data, analogous to a data type. You can now declare collation for a column and this collation is automatically applied by all collation-sensitive SQL operations referencing the column. The data-bound collation feature uses syntax and semantics compatible with the ISO/IEC SQL standard.

The PL/SQL language has limited support for the data-bound collation architecture. All data processed in PL/SQL expressions is assumed to have the compatibility collation `USING_NLS_COMP`. This pseudo-collation instructs collation-sensitive operators to behave in the same way as in previous Oracle Database releases. That is, the values of the session parameters `NLS_COMP` and `NLS_SORT` determine the collation to use. However, all SQL statements embedded or constructed dynamically in PL/SQL fully support the new architecture.

A new property called default collation has been added to tables, views, materialized views, packages, stored procedures, stored functions, triggers, and types. The default collation of a unit determines the collation for data containers, such as columns, variables, parameters, literals, and return values, that do not have their own explicit collation declaration in that unit. The default collation for packages, stored procedures, stored functions, triggers, and types must be `USING_NLS_COMP`.

For syntax and semantics, see the [DEFAULT COLLATION Clause](#).

To facilitate the creation of PL/SQL units in a schema that has a schema default collation other than `USING_NLS_COMP`, the syntax and semantics for the following statements enable an explicit declaration of the object's default collation to be `USING_NLS_COMP`:

- [CREATE FUNCTION Statement](#)
- [CREATE PACKAGE Statement](#)
- [CREATE PROCEDURE Statement](#)
- [CREATE TRIGGER Statement](#)
- [CREATE TYPE Statement](#)



See Also:

- *Oracle Database Globalization Support Guide* for more information about specifying data-bound collation for PL/SQL units
- *Oracle Database Globalization Support Guide* for more information about effective schema default collation

2.2 Lexical Units

The **lexical units** of PL/SQL are its smallest individual components—delimiters, identifiers, literals, pragmas, and comments.

Topics

- [Delimiters](#)
- [Identifiers](#)
- [Literals](#)
- [Pragmas](#)
- [Comments](#)
- [Whitespace Characters Between Lexical Units](#)

2.2.1 Delimiters

A **delimiter** is a character, or character combination, that has a special meaning in PL/SQL.

Do not embed any others characters (including whitespace characters) inside a delimiter.

Table 2-2 summarizes the PL/SQL delimiters.

Table 2-2 PL/SQL Delimiters

Delimiter	Meaning
+	Addition operator
:=	Assignment operator
=>	Association operator
⊗	Attribute indicator
'	Character string delimiter
.	Component indicator
	Concatenation operator
/	Division operator
**	Exponentiation operator
(Expression or list delimiter (begin)
)	Expression or list delimiter (end)
:	Host variable indicator
,	Item separator
<<	Label delimiter (begin)
>>	Label delimiter (end)
/*	Multiline comment delimiter (begin)
*/	Multiline comment delimiter (end)
*	Multiplication operator
"	Quoted identifier delimiter
..	Range operator
=	Relational operator (equal)
<>	Relational operator (not equal)
!=	Relational operator (not equal)
~=	Relational operator (not equal)
^=	Relational operator (not equal)
<	Relational operator (less than)
>	Relational operator (greater than)
<=	Relational operator (less than or equal)
>=	Relational operator (greater than or equal)
@	Remote access indicator
--	Single-line comment indicator
;	Statement terminator
-	Subtraction or negation operator

2.2.2 Identifiers

Identifiers name PL/SQL elements, which include:

- Constants
- Cursors
- Exceptions
- Keywords
- Labels
- Packages
- Reserved words
- Subprograms
- Types
- Variables

Every character in an identifier, alphabetic or not, is significant. For example, the identifiers `lastname` and `last_name` are different.

You must separate adjacent identifiers by one or more whitespace characters or a punctuation character.

Except as explained in "[Quoted User-Defined Identifiers](#)", PL/SQL is case-insensitive for identifiers. For example, the identifiers `lastname`, `LastName`, and `LASTNAME` are the same.

Topics

- [Reserved Words and Keywords](#)
- [Predefined Identifiers](#)
- [User-Defined Identifiers](#)

2.2.2.1 Reserved Words and Keywords

Reserved words and **keywords** are identifiers that have special meaning in PL/SQL.

You cannot use reserved words as ordinary user-defined identifiers. You can use them as quoted user-defined identifiers, but it is not recommended. For more information, see "[Quoted User-Defined Identifiers](#)".

You can use keywords as ordinary user-defined identifiers, but it is not recommended.

For lists of PL/SQL reserved words and keywords, see [Table D-1](#) and [Table D-2](#), respectively.

2.2.2.2 Predefined Identifiers

Predefined identifiers are declared in the predefined package `STANDARD`.

An example of a predefined identifier is the exception `INVALID_NUMBER`.

For a list of predefined identifiers, connect to Oracle Database as a user who has the DBA role and use this query:

```
SELECT TYPE_NAME FROM ALL_TYPES WHERE PREDEFINED='YES';
```

You can use predefined identifiers as user-defined identifiers, but it is not recommended. Your local declaration overrides the global declaration (see "[Scope and Visibility of Identifiers](#)").

2.2.2.3 User-Defined Identifiers

A **user-defined identifier** is:

- Composed of characters from the database character set
- Either ordinary or quoted

 **Tip:**

Make user-defined identifiers meaningful. For example, the meaning of `cost_per_thousand` is obvious, but the meaning of `cpt` is not.

 **Tip:**

Avoid using the same user-defined identifier for both a schema and a schema object. This decreases code readability and maintainability and can lead to coding mistakes. Note that local objects have name resolution precedence over schema qualification.

For more information about database object naming rules, see *Oracle Database SQL Language Reference*.

For more information about PL/SQL-specific name resolution rules, see "[Differences Between PL/SQL and SQL Name Resolution Rules](#)".

2.2.2.3.1 Ordinary User-Defined Identifiers

An ordinary user-defined identifier:

- Begins with a letter
- Can include letters, digits, and these symbols:
 - Dollar sign (\$)
 - Number sign (#)
 - Underscore (_)
- Is not a reserved word (listed in [Table D-1](#)).

The database character set defines which characters are classified as letters and digits. If COMPATIBLE is set to a value of 12.2 or higher, the representation of the identifier in the database character set cannot exceed 128 bytes. If COMPATIBLE is set to a value of 12.1 or lower, the limit is 30 bytes.

Examples of acceptable ordinary user-defined identifiers:

```
X  
t2  
phone#  
credit_limit  
LastName  
oracle$number  
money$$$tree  
SN##  
try_again_
```

Examples of unacceptable ordinary user-defined identifiers:

```
mine&yours  
debit-amount  
on/off  
user id
```

2.2.2.3.2 Quoted User-Defined Identifiers

A quoted user-defined identifier is enclosed in double quotation marks.

Between the double quotation marks, any characters from the database character set are allowed except double quotation marks, new line characters, and null characters. For example, these identifiers are acceptable:

```
"X+Y"  
"last name"  
"on/off switch"  
"employee(s) "  
"*** header info ***"
```

If COMPATIBLE is set to a value of 12.2 or higher, the representation of the quoted identifier in the database character set cannot exceed 128 bytes (excluding the double quotation marks). If COMPATIBLE is set to a value of 12.1 or lower, the limit is 30 bytes.

A quoted user-defined identifier is case-sensitive, with one exception: If a quoted user-defined identifier, without its enclosing double quotation marks, is a valid *ordinary* user-defined identifier, then the double quotation marks are optional in references to the identifier, and if you omit them, then the identifier is case-insensitive.

It is not recommended, but you can use a reserved word as a quoted user-defined identifier. Because a reserved word is not a valid ordinary user-defined identifier, you must always enclose the identifier in double quotation marks, and it is always case-sensitive.

Example 2-1 Valid Case-Insensitive Reference to Quoted User-Defined Identifier

In this example, the quoted user-defined identifier "HELLO", without its enclosing double quotation marks, is a valid ordinary user-defined identifier. Therefore, the reference Hello is valid.

```
DECLARE  
  "HELLO" varchar2(10) := 'hello';  
BEGIN  
  DBMS_Output.Put_Line(Hello);
```

```
END;  
/
```

Result:

```
hello
```

Example 2-2 Invalid Case-Insensitive Reference to Quoted User-Defined Identifier

In this example, the reference "Hello" is invalid, because the double quotation marks make the identifier case-sensitive.

```
DECLARE  
  "HELLO" varchar2(10) := 'hello';  
BEGIN  
  DBMS_Output.Put_Line("Hello");  
END;  
/
```

Result:

```
  DBMS_Output.Put_Line("Hello");  
                          *  
ERROR at line 4:  
ORA-06550: line 4, column 25:  
PLS-00201: identifier 'Hello' must be declared  
ORA-06550: line 4, column 3:  
PL/SQL: Statement ignored
```

Example 2-3 Reserved Word as Quoted User-Defined Identifier

This example declares quoted user-defined identifiers "BEGIN", "Begin", and "begin". Although BEGIN, Begin, and begin represent the same reserved word, "BEGIN", "Begin", and "begin" represent different identifiers.

```
DECLARE  
  "BEGIN" varchar2(15) := 'UPPERCASE';  
  "Begin" varchar2(15) := 'Initial Capital';  
  "begin" varchar2(15) := 'lowercase';  
BEGIN  
  DBMS_Output.Put_Line("BEGIN");  
  DBMS_Output.Put_Line("Begin");  
  DBMS_Output.Put_Line("begin");  
END;  
/
```

Result:

```
UPPERCASE  
Initial Capital  
lowercase  
  
PL/SQL procedure successfully completed.
```

Example 2-4 Neglecting Double Quotation Marks

This example references a quoted user-defined identifier that is a reserved word, neglecting to enclose it in double quotation marks.

```
DECLARE  
  "HELLO" varchar2(10) := 'hello'; -- HELLO is not a reserved word  
  "BEGIN" varchar2(10) := 'begin'; -- BEGIN is a reserved word
```

```

BEGIN
  DBMS_Output.Put_Line>Hello);          -- Double quotation marks are optional
  DBMS_Output.Put_Line(BEGIN);         -- Double quotation marks are required
end;
/

```

Result:

```

      DBMS_Output.Put_Line(BEGIN);      -- Double quotation marks are required
                                *
ERROR at line 6:
ORA-06550: line 6, column 24:
PLS-00103: Encountered the symbol "BEGIN" when expecting one of the following:
( ) - + case mod new not null <an identifier>
<a double-quoted delimited-identifier> <a bind variable>
table continue avg count current exists max min prior sql
stddev sum variance execute multiset the both leading
trailing forall merge year month day hour minute second
timezone_hour timezone_minute timezone_region timezone_abbr
time timestamp interval date
<a string literal with character set specificat

```

Example 2-5 Neglecting Case-Sensitivity

This example references a quoted user-defined identifier that is a reserved word, neglecting its case-sensitivity.

```

DECLARE
  "HELLO" varchar2(10) := 'hello';    -- HELLO is not a reserved word
  "BEGIN" varchar2(10) := 'begin';    -- BEGIN is a reserved word
BEGIN
  DBMS_Output.Put_Line>Hello);          -- Identifier is case-insensitive
  DBMS_Output.Put_Line("Begin");       -- Identifier is case-sensitive
END;
/

```

Result:

```

      DBMS_Output.Put_Line("Begin");    -- Identifier is case-sensitive
                                *
ERROR at line 6:
ORA-06550: line 6, column 25:
PLS-00201: identifier 'Begin' must be declared
ORA-06550: line 6, column 3:
PL/SQL: Statement ignored

```

2.2.3 Literals

A **literal** is a value that is neither represented by an identifier nor calculated from other values.

For example, 123 is an integer literal and 'abc' is a character literal, but 1+2 is not a literal.

PL/SQL literals include all SQL literals (described in *Oracle Database SQL Language Reference*) and `BOOLEAN` literals (which SQL does not have). A `BOOLEAN` literal is the predefined logical value `TRUE`, `FALSE`, or `NULL`. `NULL` represents an unknown value.

 **Note:**

Like *Oracle Database SQL Language Reference*, this document uses the terms *character literal* and *string* interchangeably.

When using character literals in PL/SQL, remember:

- Character literals are case-sensitive.
For example, 'Z' and 'z' are different.
- Whitespace characters are significant.
For example, these literals are different:

```
'abc'  
' abc'  
'abc '  
' abc '  
'a b c'
```

- PL/SQL has no line-continuation character that means "this string continues on the next source line." If you continue a string on the next source line, then the string includes a line-break character.

For example, this PL/SQL code:

```
BEGIN  
  DBMS_OUTPUT.PUT_LINE('This string breaks  
here.');
```

Prints this:

```
This string breaks  
here.
```

If your string does not fit on a source line and you do not want it to include a line-break character, then construct the string with the concatenation operator (||).

For example, this PL/SQL code:

```
BEGIN  
  DBMS_OUTPUT.PUT_LINE('This string ' ||  
                        'contains no line-break character.');
```

Prints this:

```
This string contains no line-break character.
```

For more information about the concatenation operator, see "[Concatenation Operator](#)".

- '0' through '9' are not equivalent to the integer literals 0 through 9.
However, because PL/SQL converts them to integers, you can use them in arithmetic expressions.
- A character literal with zero characters has the value `NULL` and is called a **null string**.

However, this `NULL` value is not the `BOOLEAN` value `NULL`.

- An **ordinary character literal** is composed of characters in the **database character set**.

For information about the database character set, see *Oracle Database Globalization Support Guide*.

- A **national character literal** is composed of characters in the **national character set**.

For information about the national character set, see *Oracle Database Globalization Support Guide*.

- You can use `Q` or `q` as part of the character literal syntax to indicate that an alternative quoting mechanism will be used. This mechanism allows a wide range of delimiters for a string as opposed to simply single quotation marks.

For more information about the alternative quoting mechanism, see *Oracle Database SQL Language Reference*.

Live SQL:

You can view and run examples of the `Q` mechanism at [Alternative Quoting Mechanism \("Q"\) for String Literals](#)

2.2.4 Pragma

A **pragma** is an instruction to the compiler that it processes at compile time.

A pragma begins with the reserved word `PRAGMA` followed by the name of the pragma. Some pragmas have arguments. A pragma may appear before a declaration or a statement. Additional restrictions may apply for specific pragmas. The extent of a pragma's effect depends on the pragma. A pragma whose name or argument is not recognized by the compiler has no effect.

pragma ::=

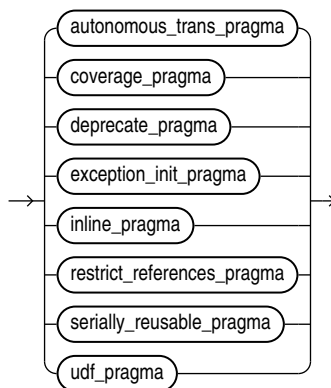

For information about pragmas syntax and semantics, see :

- ["AUTONOMOUS_TRANSACTION Pragma"](#)
- ["COVERAGE Pragma"](#)
- ["DEPRECATE Pragma"](#)
- ["EXCEPTION_INIT Pragma"](#)
- ["INLINE Pragma"](#)
- ["RESTRICT_REFERENCES Pragma"](#)
- ["SERIALLY_REUSABLE Pragma"](#)
- ["UDF Pragma"](#)

2.2.5 Comments

The PL/SQL compiler ignores comments. Their purpose is to help other application developers understand your source text.

Typically, you use comments to describe the purpose and use of each code segment. You can also disable obsolete or unfinished pieces of code by turning them into comments.

Topics

- [Single-Line Comments](#)
- [Multiline Comments](#)



See Also:

["Comment"](#)

2.2.5.1 Single-Line Comments

A single-line comment begins with `--` and extends to the end of the line.



Caution:

Do not put a single-line comment in a PL/SQL block to be processed dynamically by an Oracle Precompiler program. The Oracle Precompiler program ignores end-of-line characters, which means that a single-line comment ends when the block ends.

While testing or debugging a program, you can disable a line of code by making it a comment. For example:

```
-- DELETE FROM employees WHERE comm_pct IS NULL
```

Example 2-6 Single-Line Comments

This example has three single-line comments.

```
DECLARE  
    howmany    NUMBER;
```

```

    num_tables NUMBER;
BEGIN
    -- Begin processing
    SELECT COUNT(*) INTO howmany
    FROM USER_OBJECTS
    WHERE OBJECT_TYPE = 'TABLE'; -- Check number of tables
    num_tables := howmany;      -- Compute another value
END;
/

```

2.2.5.2 Multiline Comments

A multiline comment begins with `/*`, ends with `*/`, and can span multiple lines.

You can use multiline comment delimiters to "comment out" sections of code. When doing so, be careful not to cause nested multiline comments. One multiline comment cannot contain another multiline comment. However, a multiline comment can contain a single-line comment. For example, this causes a syntax error:

```

/*
  IF 2 + 2 = 4 THEN
    some_condition := TRUE;
  /* We expect this THEN to always be performed */
  END IF;
*/

```

This does not cause a syntax error:

```

/*
  IF 2 + 2 = 4 THEN
    some_condition := TRUE;
  -- We expect this THEN to always be performed
  END IF;
*/

```

Example 2-7 Multiline Comments

This example has two multiline comments. (The SQL function `TO_CHAR` returns the character equivalent of its argument. For more information about `TO_CHAR`, see *Oracle Database SQL Language Reference*.)

```

DECLARE
    some_condition BOOLEAN;
    pi              NUMBER := 3.1415926;
    radius         NUMBER := 15;
    area           NUMBER;
BEGIN
    /* Perform some simple tests and assignments */

    IF 2 + 2 = 4 THEN
        some_condition := TRUE;
    /* We expect this THEN to always be performed */
    END IF;

    /* This line computes the area of a circle using pi,
    which is the ratio between the circumference and diameter.
    After the area is computed, the result is displayed. */

    area := pi * radius**2;
    DBMS_OUTPUT.PUT_LINE('The area is: ' || TO_CHAR(area));
END;

```

/

Result:

The area is: 706.858335

2.2.6 Whitespace Characters Between Lexical Units

You can put whitespace characters between lexical units, which often makes your source text easier to read.

Example 2-8 Whitespace Characters Improving Source Text Readability

```
DECLARE
  x    NUMBER := 10;
  y    NUMBER := 5;
  max  NUMBER;
BEGIN
  IF x>y THEN max:=x;ELSE max:=y;END IF;  -- correct but hard to read

  -- Easier to read:

  IF x > y THEN
    max:=x;
  ELSE
    max:=y;
  END IF;
END;
/
```

2.3 Declarations

A declaration allocates storage space for a value of a specified data type, and names the storage location so that you can reference it.

You must declare objects before you can reference them. Declarations can appear in the declarative part of any block, subprogram, or package.

Topics

- [Declaring Variables](#)
- [Declaring Constants](#)
- [Initial Values of Variables and Constants](#)
- [NOT NULL Constraint](#)
- [Declaring Items using the %TYPE Attribute](#)

For information about declaring objects other than variables and constants, see the syntax of *declare_section* in "[Block](#)".

2.3.1 NOT NULL Constraint

You can impose the `NOT NULL` constraint on a scalar variable or constant (or scalar component of a composite variable or constant).

The `NOT NULL` constraint prevents assigning a null value to the item. The item can acquire this constraint either implicitly (from its data type) or explicitly.

A scalar variable declaration that specifies `NOT NULL`, either implicitly or explicitly, must assign an initial value to the variable (because the default initial value for a scalar variable is `NULL`).

PL/SQL treats any zero-length string as a `NULL` value. This includes values returned by character functions and `BOOLEAN` expressions.

To test for a `NULL` value, use the ["IS \[NOT\] NULL Operator"](#).

Examples

Example 2-9 Variable Declaration with NOT NULL Constraint

In this example, the variable `acct_id` acquires the `NOT NULL` constraint explicitly, and the variables `a`, `b`, and `c` acquire it from their data types.

```
DECLARE
  acct_id INTEGER(4) NOT NULL := 9999;
  a NATURALN           := 9999;
  b POSITIVEN          := 9999;
  c SIMPLE_INTEGER     := 9999;
BEGIN
  NULL;
END;
/
```

Example 2-10 Variables Initialized to NULL Values

In this example, all variables are initialized to `NULL`.

```
DECLARE
  null_string VARCHAR2(80) := TO_CHAR('');
  address     VARCHAR2(80);
  zip_code    VARCHAR2(80) := SUBSTR(address, 25, 0);
  name        VARCHAR2(80);
  valid       BOOLEAN      := (name != '');
BEGIN
  NULL;
END;
/
```

2.3.2 Declaring Variables

A variable declaration always specifies the name and data type of the variable.

For most data types, a variable declaration can also specify an initial value.

The variable name must be a valid user-defined identifier .

The data type can be any PL/SQL data type. The PL/SQL data types include the SQL data types. A data type is either scalar (without internal components) or composite (with internal components).

Example

Example 2-11 Scalar Variable Declarations

This example declares several variables with scalar data types.

```

DECLARE
    part_number      NUMBER(6);      -- SQL data type
    part_name        VARCHAR2(20);   -- SQL data type
    in_stock         BOOLEAN;        -- PL/SQL-only data type
    part_price       NUMBER(6,2);    -- SQL data type
    part_description VARCHAR2(50);   -- SQL data type
BEGIN
    NULL;
END;
/

```

Related Topics

- ["User-Defined Identifiers"](#)
- ["Scalar Variable Declaration"](#) for scalar variable declaration syntax
- [PL/SQL Data Types](#) for information about scalar data types
- [PL/SQL Collections and Records](#), for information about composite data types and variables

2.3.3 Declaring Constants

A constant holds a value that does not change.

The information in ["Declaring Variables"](#) also applies to constant declarations, but a constant declaration has two more requirements: the keyword `CONSTANT` and the initial value of the constant. (The initial value of a constant is its permanent value.)

Example 2-12 Constant Declarations

This example declares three constants with scalar data types.

```

DECLARE
    credit_limit     CONSTANT REAL      := 5000.00;  -- SQL data type
    max_days_in_year CONSTANT INTEGER := 366;      -- SQL data type
    urban_legend     CONSTANT BOOLEAN := FALSE;    -- PL/SQL-only data type
BEGIN
    NULL;
END;
/

```

Related Topic

- ["Constant Declaration"](#) for constant declaration syntax

2.3.4 Initial Values of Variables and Constants

In a variable declaration, the initial value is optional unless you specify the `NOT NULL` constraint. In a constant declaration, the initial value is required.

If the declaration is in a block or subprogram, the initial value is assigned to the variable or constant every time control passes to the block or subprogram. If the declaration is in a

package specification, the initial value is assigned to the variable or constant for each session (whether the variable or constant is public or private).

To specify the initial value, use either the assignment operator (`:=`) or the keyword `DEFAULT`, followed by an expression. The expression can include previously declared constants and previously initialized variables.

If you do not specify an initial value for a variable, assign a value to it before using it in any other context.

Examples

Example 2-13 Variable and Constant Declarations with Initial Values

This example assigns initial values to the constant and variables that it declares. The initial value of `area` depends on the previously declared constant `pi` and the previously initialized variable `radius`.

```
DECLARE
  hours_worked    INTEGER := 40;
  employee_count  INTEGER := 0;

  pi              CONSTANT REAL := 3.14159;
  radius          REAL := 1;
  area            REAL := (pi * radius**2);
BEGIN
  NULL;
END;
/
```

Example 2-14 Variable Initialized to NULL by Default

In this example, the variable `counter` has the initial value `NULL`, by default. The example uses the ["IS \[NOT\] NULL Operator"](#) to show that `NULL` is different from zero.

```
DECLARE
  counter INTEGER; -- initial value is NULL by default
BEGIN
  counter := counter + 1; -- NULL + 1 is still NULL

  IF counter IS NULL THEN
    DBMS_OUTPUT.PUT_LINE('counter is NULL.');
```

Result:

```
counter is NULL.
```

Related Topics

- ["Declaring Associative Array Constants"](#) for information about declaring constant associative arrays
- ["Declaring Record Constants"](#) for information about declaring constant records
- ["NOT NULL Constraint"](#)

2.3.5 Declaring Items using the %TYPE Attribute

The %TYPE attribute lets you declare a data item of the same data type as a previously declared variable or column (without knowing what that type is). If the declaration of the referenced item changes, then the declaration of the referencing item changes accordingly.

The syntax of the declaration is:

```
referencing_item referenced_item%TYPE;
```

For the kinds of items that can be referencing and referenced items, see "[%TYPE Attribute](#)".

The referencing item inherits the following from the referenced item:

- Data type and size
- Constraints (unless the referenced item is a column)

The referencing item does not inherit the initial value of the referenced item. Therefore, if the referencing item specifies or inherits the NOT NULL constraint, you must specify an initial value for it.

The %TYPE attribute is particularly useful when declaring variables to hold database values. The syntax for declaring a variable of the same type as a column is:

```
variable_name table_name.column_name%TYPE;
```



See Also:

"[Declaring Items using the %ROWTYPE Attribute](#)", which lets you declare a record variable that represents either a full or partial row of a database table or view

Examples

Example 2-15 Declaring Variable of Same Type as Column

In this example, the variable `surname` inherits the data type and size of the column `employees.last_name`, which has a NOT NULL constraint. Because `surname` does not inherit the NOT NULL constraint, its declaration does not need an initial value.

```
DECLARE
  surname employees.last_name%TYPE;
BEGIN
  DBMS_OUTPUT.PUT_LINE('surname=' || surname);
END;
/
```

Result:

```
surname=
```

Example 2-16 Declaring Variable of Same Type as Another Variable

In this example, the variable `surname` inherits the data type, size, and NOT NULL constraint of the variable `name`. Because `surname` does not inherit the initial value of `name`, its declaration needs an initial value (which cannot exceed 25 characters).

```
DECLARE
  name      VARCHAR(25) NOT NULL := 'Smith';
  surname   name%TYPE := 'Jones';
BEGIN
  DBMS_OUTPUT.PUT_LINE('name=' || name);
  DBMS_OUTPUT.PUT_LINE('surname=' || surname);
END;
/
```

Result:

```
name=Smith
surname=Jones
```

2.4 References to Identifiers

When referencing an identifier, you use a name that is either simple, qualified, remote, or both qualified and remote.

The **simple name** of an identifier is the name in its declaration. For example:

```
DECLARE
  a INTEGER; -- Declaration
BEGIN
  a := 1;    -- Reference with simple name
END;
/
```

If an identifier is declared in a named PL/SQL unit, you can (and sometimes must) reference it with its **qualified name**. The syntax (called **dot notation**) is:

```
unit_name.simple_identifier_name
```

For example, if package *p* declares identifier *a*, you can reference the identifier with the qualified name *p.a*. The unit name also can (and sometimes must) be qualified. You *must* qualify an identifier when it is not visible (see "[Scope and Visibility of Identifiers](#)").

If the identifier names an object on a remote database, you must reference it with its **remote name**. The syntax is:

```
simple_identifier_name@link_to_remote_database
```

If the identifier is declared in a PL/SQL unit on a remote database, you must reference it with its **qualified remote name**. The syntax is:

```
unit_name.simple_identifier_name@link_to_remote_database
```

You can create synonyms for remote schema objects, but you cannot create synonyms for objects declared in PL/SQL subprograms or packages. To create a synonym, use the SQL statement `CREATE SYNONYM`, explained in *Oracle Database SQL Language Reference*.

For information about how PL/SQL resolves ambiguous names, see [PL/SQL Name Resolution](#).

**Note:**

You can reference identifiers declared in the packages `STANDARD` and `DBMS_STANDARD` without qualifying them with the package names, unless you have declared a local identifier with the same name (see "[Scope and Visibility of Identifiers](#)").

2.5 Scope and Visibility of Identifiers

The **scope** of an identifier is the region of a PL/SQL unit from which you can reference the identifier. The **visibility** of an identifier is the region of a PL/SQL unit from which you can reference the identifier without qualifying it. An identifier is **local** to the PL/SQL unit that declares it. If that unit has subunits, the identifier is **global** to them.

If a subunit redeclares a global identifier, then inside the subunit, both identifiers are in scope, but only the local identifier is visible. To reference the global identifier, the subunit must qualify it with the name of the unit that declared it. If that unit has no name, then the subunit cannot reference the global identifier.

A PL/SQL unit cannot reference identifiers declared in other units at the same level, because those identifiers are neither local nor global to the block.

You cannot declare the same identifier twice in the same PL/SQL unit. If you do, an error occurs when you reference the duplicate identifier.

You can declare the same identifier in two different units. The two objects represented by the identifier are distinct. Changing one does not affect the other.

In the same scope, give labels and subprograms unique names to avoid confusion and unexpected results.

Examples

Example 2-17 Scope and Visibility of Identifiers

This example shows the scope and visibility of several identifiers. The first sub-block redeclares the global identifier `a`. To reference the global variable `a`, the first sub-block would have to qualify it with the name of the outer block—but the outer block has no name. Therefore, the first sub-block cannot reference the global variable `a`; it can reference only its local variable `a`. Because the sub-blocks are at the same level, the first sub-block cannot reference `d`, and the second sub-block cannot reference `c`.

```
-- Outer block:
DECLARE
  a CHAR;  -- Scope of a (CHAR) begins
  b REAL;  -- Scope of b begins
BEGIN
  -- Visible: a (CHAR), b

  -- First sub-block:
  DECLARE
    a INTEGER;  -- Scope of a (INTEGER) begins
    c REAL;     -- Scope of c begins
  BEGIN
    -- Visible: a (INTEGER), b, c
```

```

    NULL;
END;          -- Scopes of a (INTEGER) and c end

-- Second sub-block:
DECLARE
    d REAL;    -- Scope of d begins
BEGIN
    -- Visible: a (CHAR), b, d
    NULL;
END;          -- Scope of d ends

-- Visible: a (CHAR), b
END;          -- Scopes of a (CHAR) and b end
/

```

Example 2-18 Qualifying Redeclared Global Identifier with Block Label

This example labels the outer block with the name `outer`. Therefore, after the sub-block redeclares the global variable `birthdate`, it can reference that global variable by qualifying its name with the block label. The sub-block can also reference its local variable `birthdate`, by its simple name.

```

<<outer>> -- label
DECLARE
    birthdate DATE := TO_DATE('09-AUG-70', 'DD-MON-YY');
BEGIN
    DECLARE
        birthdate DATE := TO_DATE('29-SEP-70', 'DD-MON-YY');
    BEGIN
        IF birthdate = outer.birthdate THEN
            DBMS_OUTPUT.PUT_LINE ('Same Birthday');
        ELSE
            DBMS_OUTPUT.PUT_LINE ('Different Birthday');
        END IF;
    END;
END;
/

```

Result:

```
Different Birthday
```

Example 2-19 Qualifying Identifier with Subprogram Name

In this example, the procedure `check_credit` declares a variable, `rating`, and a function, `check_rating`. The function redeclares the variable. Then the function references the global variable by qualifying it with the procedure name.

```

CREATE OR REPLACE PROCEDURE check_credit (credit_limit NUMBER) AS
    rating NUMBER := 3;

FUNCTION check_rating RETURN BOOLEAN IS
    rating NUMBER := 1;
    over_limit BOOLEAN;
BEGIN
    IF check_credit.rating <= credit_limit THEN -- reference global variable
        over_limit := FALSE;
    ELSE
        over_limit := TRUE;
        rating := credit_limit; -- reference local variable
    END IF;
END;

```

```
        END IF;
        RETURN over_limit;
    END check_rating;
BEGIN
    IF check_rating THEN
        DBMS_OUTPUT.PUT_LINE
            ('Credit rating over limit (' || TO_CHAR(credit_limit) || '). '
             || 'Rating: ' || TO_CHAR(rating));
    ELSE
        DBMS_OUTPUT.PUT_LINE
            ('Credit rating OK. ' || 'Rating: ' || TO_CHAR(rating));
    END IF;
END;
/

BEGIN
    check_credit(1);
END;
/
```

Result:

Credit rating over limit (1). Rating: 3

Example 2-20 Duplicate Identifiers in Same Scope

You cannot declare the same identifier twice in the same PL/SQL unit. If you do, an error occurs when you reference the duplicate identifier, as this example shows.

```
DECLARE
    id BOOLEAN;
    id VARCHAR2(5); -- duplicate identifier
BEGIN
    id := FALSE;
END;
/
```

Result:

```
    id := FALSE;
    *
ERROR at line 5:
ORA-06550: line 5, column 3:
PLS-00371: at most one declaration for 'ID' is permitted
ORA-06550: line 5, column 3:
PL/SQL: Statement ignored
```

Example 2-21 Declaring Same Identifier in Different Units

You can declare the same identifier in two different units. The two objects represented by the identifier are distinct. Changing one does not affect the other, as this example shows. In the same scope, give labels and subprograms unique names to avoid confusion and unexpected results.

```
DECLARE
    PROCEDURE p
    IS
        x VARCHAR2(1);
    BEGIN
        x := 'a'; -- Assign the value 'a' to x
```

```

        DBMS_OUTPUT.PUT_LINE('In procedure p, x = ' || x);
    END;

    PROCEDURE q
    IS
        x VARCHAR2(1);
    BEGIN
        x := 'b'; -- Assign the value 'b' to x
        DBMS_OUTPUT.PUT_LINE('In procedure q, x = ' || x);
    END;

BEGIN
    p;
    q;
END;
/

```

Result:

```

In procedure p, x = a
In procedure q, x = b

```

Example 2-22 Label and Subprogram with Same Name in Same Scope

In this example, `echo` is the name of both a block and a subprogram. Both the block and the subprogram declare a variable named `x`. In the subprogram, `echo.x` refers to the local variable `x`, not to the global variable `x`.

```

<<echo>>
DECLARE
    x NUMBER := 5;

    PROCEDURE echo AS
        x NUMBER := 0;
    BEGIN
        DBMS_OUTPUT.PUT_LINE('x = ' || x);
        DBMS_OUTPUT.PUT_LINE('echo.x = ' || echo.x);
    END;

BEGIN
    echo;
END;
/

```

Result:

```

x = 0
echo.x = 0

```

Example 2-23 Block with Multiple and Duplicate Labels

This example has two labels for the outer block, `compute_ratio` and `another_label`. The second label appears again in the inner block. In the inner block, `another_label.denominator` refers to the local variable `denominator`, not to the global variable `denominator`, which results in the error `ZERO_DIVIDE`.

```

<<compute_ratio>>
<<another_label>>
DECLARE
    numerator NUMBER := 22;

```

```
denominator NUMBER := 7;
BEGIN
  <<another_label>>
  DECLARE
    denominator NUMBER := 0;
  BEGIN
    DBMS_OUTPUT.PUT_LINE('Ratio with compute_ratio.denominator = ');
    DBMS_OUTPUT.PUT_LINE( numerator/compute_ratio.denominator);

    DBMS_OUTPUT.PUT_LINE('Ratio with another_label.denominator = ');
    DBMS_OUTPUT.PUT_LINE( numerator/another_label.denominator);

  EXCEPTION
    WHEN ZERO_DIVIDE THEN
      DBMS_OUTPUT.PUT_LINE('Divide-by-zero error: can''t divide '
        || numerator || ' by ' || denominator);
    WHEN OTHERS THEN
      DBMS_OUTPUT.PUT_LINE('Unexpected error. ');
  END another_label;
END compute_ratio;
/
```

Result:

```
Ratio with compute_ratio.denominator =
3.14285714285714285714285714285714
Ratio with another_label.denominator =
Divide-by-zero error: cannot divide 22 by 0
```

2.6 Assigning Values to Variables

After declaring a variable, you can assign a value to it in these ways:

- Use the assignment statement to assign it the value of an expression.
- Use the `SELECT INTO` or `FETCH` statement to assign it a value from a table.
- Pass it to a subprogram as an `OUT` or `IN OUT` parameter, and then assign the value inside the subprogram.

The variable and the value must have compatible data types. One data type is **compatible** with another data type if it can be implicitly converted to that type. For information about implicit data conversion, see *Oracle Database SQL Language Reference*.

Topics

- [Assigning Values to Variables with the Assignment Statement](#)
- [Assigning Values to Variables with the SELECT INTO Statement](#)
- [Assigning Values to Variables as Parameters of a Subprogram](#)
- [Assigning Values to BOOLEAN Variables](#)

 **See Also:**

- ["Assigning Values to Collection Variables"](#)
- ["Assigning Values to Record Variables"](#)
- ["FETCH Statement"](#)

2.6.1 Assigning Values to Variables with the Assignment Statement

To assign the value of an expression to a variable, use this form of the assignment statement:

```
variable_name := expression;
```

For the complete syntax of the assignment statement, see ["Assignment Statement"](#).

For the syntax of an expression, see ["Expression"](#).

Example 2-24 Assigning Values to Variables with Assignment Statement

This example declares several variables (specifying initial values for some) and then uses assignment statements to assign the values of expressions to them.

```
DECLARE -- You can assign initial values here
wages          NUMBER;
hours_worked   NUMBER := 40;
hourly_salary  NUMBER := 22.50;
bonus          NUMBER := 150;
country        VARCHAR2(128);
counter        NUMBER := 0;
done           BOOLEAN;
valid_id       BOOLEAN;
emp_rec1       employees%ROWTYPE;
emp_rec2       employees%ROWTYPE;
TYPE commissions IS TABLE OF NUMBER INDEX BY PLS_INTEGER;
comm_tab       commissions;

BEGIN -- You can assign values here too
wages := (hours_worked * hourly_salary) + bonus;
country := 'France';
country := UPPER('Canada');
done := (counter > 100);
valid_id := TRUE;
emp_rec1.first_name := 'Antonio';
emp_rec1.last_name := 'Ortiz';
emp_rec1 := emp_rec2;
comm_tab(5) := 20000 * 0.15;
END;
/
```

2.6.2 Assigning Values to Variables with the SELECT INTO Statement

A simple form of the `SELECT INTO` statement is:

```
SELECT select_item [, select_item ]...  
INTO variable_name [, variable_name ]...  
FROM table_name;
```

For each *select_item*, there must be a corresponding, type-compatible *variable_name*. Because SQL does not have a `BOOLEAN` type, *variable_name* cannot be a `BOOLEAN` variable.

For the complete syntax of the `SELECT INTO` statement, see "[SELECT INTO Statement](#)".

Example 2-25 Assigning Value to Variable with `SELECT INTO` Statement

This example uses a `SELECT INTO` statement to assign to the variable `bonus` the value that is 10% of the salary of the employee whose `employee_id` is 100.

```
DECLARE  
    bonus    NUMBER(8,2);  
BEGIN  
    SELECT salary * 0.10 INTO bonus  
    FROM employees  
    WHERE employee_id = 100;  
END;  
  
DBMS_OUTPUT.PUT_LINE('bonus = ' || TO_CHAR(bonus));  
/
```

Result:

```
bonus = 2400
```

2.6.3 Assigning Values to Variables as Parameters of a Subprogram

If you pass a variable to a subprogram as an `OUT` or `IN OUT` parameter, and the subprogram assigns a value to the parameter, the variable retains that value after the subprogram finishes running. For more information, see "[Subprogram Parameters](#)".

Example 2-26 Assigning Value to Variable as `IN OUT` Subprogram Parameter

This example passes the variable `new_sal` to the procedure `adjust_salary`. The procedure assigns a value to the corresponding formal parameter, `sal`. Because `sal` is an `IN OUT` parameter, the variable `new_sal` retains the assigned value after the procedure finishes running.

```
DECLARE  
    emp_salary    NUMBER(8,2);  
  
    PROCEDURE adjust_salary (  
        emp        NUMBER,  
        sal IN OUT NUMBER,  
        adjustment NUMBER  
    ) IS  
    BEGIN  
        sal := sal + adjustment;  
    END;  
  
BEGIN  
    SELECT salary INTO emp_salary  
    FROM employees  
    WHERE employee_id = 100;  
  
    DBMS_OUTPUT.PUT_LINE
```

```

('Before invoking procedure, emp_salary: ' || emp_salary);

adjust_salary (100, emp_salary, 1000);

DBMS_OUTPUT.PUT_LINE
('After invoking procedure, emp_salary: ' || emp_salary);
END;
/

```

Result:

```

Before invoking procedure, emp_salary: 24000
After invoking procedure, emp_salary: 25000

```

2.6.4 Assigning Values to BOOLEAN Variables

The only values that you can assign to a `BOOLEAN` variable are `TRUE`, `FALSE`, and `NULL`.

For more information about the `BOOLEAN` data type, see "[BOOLEAN Data Type](#)".

Example 2-27 Assigning Value to BOOLEAN Variable

This example initializes the `BOOLEAN` variable `done` to `NULL` by default, assigns it the literal value `FALSE`, compares it to the literal value `TRUE`, and assigns it the value of a `BOOLEAN` expression.

```

DECLARE
  done    BOOLEAN;           -- Initial value is NULL by default
  counter NUMBER := 0;
BEGIN
  done := FALSE;           -- Assign literal value
  WHILE done != TRUE      -- Compare to literal value
  LOOP
    counter := counter + 1;
    done := (counter > 500); -- Assign value of BOOLEAN expression
  END LOOP;
END;
/

```

2.7 Expressions

An expression is a combination of one or more values, operators, and SQL functions that evaluates to a value.

An expression always returns a single value. The simplest expressions, in order of increasing complexity, are:

1. A single constant or variable (for example, `a`)
2. A unary operator and its single operand (for example, `-a`)
3. A binary operator and its two operands (for example, `a+b`)

An **operand** can be a variable, constant, literal, operator, function invocation, or placeholder—or another expression. Therefore, expressions can be arbitrarily complex. For expression syntax, see [Expression](#).

The data types of the operands determine the data type of the expression. Every time the expression is evaluated, a single value of that data type results. The data type of that result is the data type of the expression.

Topics

- [Concatenation Operator](#)
- [Operator Precedence](#)
- [Logical Operators](#)
- [Short-Circuit Evaluation](#)
- [Comparison Operators](#)
- [BOOLEAN Expressions](#)
- [CASE Expressions](#)
- [SQL Functions in PL/SQL Expressions](#)

2.7.1 Concatenation Operator

The concatenation operator (`||`) appends one string operand to another.

The concatenation operator ignores null operands.

For more information about the syntax of the concatenation operator, see "[character_expression ::=](#)".

Example 2-28 Concatenation Operator

```
DECLARE
  x VARCHAR2(4) := 'suit';
  y VARCHAR2(4) := 'case';
BEGIN
  DBMS_OUTPUT.PUT_LINE (x || y);
END;
/
```

Result:

```
suitcase
```

Example 2-29 Concatenation Operator with NULL Operands

The concatenation operator ignores null operands, as this example shows.

```
BEGIN
  DBMS_OUTPUT.PUT_LINE ('apple' || NULL || NULL || 'sauce');
END;
/
```

Result:

```
applesauce
```

2.7.2 Operator Precedence

An **operation** is either a unary operator and its single operand or a binary operator and its two operands. The operations in an expression are evaluated in order of operator precedence.

[Table 2-3](#) shows operator precedence from highest to lowest. Operators with equal precedence are evaluated in no particular order.

Table 2-3 Operator Precedence

Operator	Operation
**	exponentiation
+, -	identity, negation
*, /	multiplication, division
+, -,	addition, subtraction, concatenation
=, <, >, <=, >=, <>, !=, ~=, ^=, IS NULL, LIKE, BETWEEN, IN	comparison
NOT	negation
AND	conjunction
OR	inclusion

To control the order of evaluation, enclose operations in parentheses, as in [Example 2-30](#).

When parentheses are nested, the most deeply nested operations are evaluated first.

You can also use parentheses to improve readability where the parentheses do not affect evaluation order.

Example 2-30 Controlling Evaluation Order with Parentheses

```
DECLARE
  a INTEGER := 1+2**2;
  b INTEGER := (1+2)**2;
BEGIN
  DBMS_OUTPUT.PUT_LINE('a = ' || TO_CHAR(a));
  DBMS_OUTPUT.PUT_LINE('b = ' || TO_CHAR(b));
END;
/
```

Result:

```
a = 5
b = 9
```

Example 2-31 Expression with Nested Parentheses

In this example, the operations (1+2) and (3+4) are evaluated first, producing the values 3 and 7, respectively. Next, the operation 3*7 is evaluated, producing the result 21. Finally, the operation 21/7 is evaluated, producing the final value 3.

```
DECLARE
  a INTEGER := ((1+2)*(3+4))/7;
```

```
BEGIN
  DBMS_OUTPUT.PUT_LINE('a = ' || TO_CHAR(a));
END;
/
```

Result:

```
a = 3
```

Example 2-32 Improving Readability with Parentheses

In this example, the parentheses do not affect the evaluation order. They only improve readability.

```
DECLARE
  a INTEGER := 2**2*3**2;
  b INTEGER := (2**2)*(3**2);
BEGIN
  DBMS_OUTPUT.PUT_LINE('a = ' || TO_CHAR(a));
  DBMS_OUTPUT.PUT_LINE('b = ' || TO_CHAR(b));
END;
/
```

Result:

```
a = 36
b = 36
```

Example 2-33 Operator Precedence

This example shows the effect of operator precedence and parentheses in several more complex expressions.

```
DECLARE
  salary      NUMBER := 60000;
  commission  NUMBER := 0.10;
BEGIN
  -- Division has higher precedence than addition:

  DBMS_OUTPUT.PUT_LINE('5 + 12 / 4 = ' || TO_CHAR(5 + 12 / 4));
  DBMS_OUTPUT.PUT_LINE('12 / 4 + 5 = ' || TO_CHAR(12 / 4 + 5));

  -- Parentheses override default operator precedence:

  DBMS_OUTPUT.PUT_LINE('8 + 6 / 2 = ' || TO_CHAR(8 + 6 / 2));
  DBMS_OUTPUT.PUT_LINE('(8 + 6) / 2 = ' || TO_CHAR((8 + 6) / 2));

  -- Most deeply nested operation is evaluated first:

  DBMS_OUTPUT.PUT_LINE('100 + (20 / 5 + (7 - 3)) = '
    || TO_CHAR(100 + (20 / 5 + (7 - 3))));

  -- Parentheses, even when unnecessary, improve readability:

  DBMS_OUTPUT.PUT_LINE('(salary * 0.05) + (commission * 0.25) = '
    || TO_CHAR((salary * 0.05) + (commission * 0.25))
  );

  DBMS_OUTPUT.PUT_LINE('salary * 0.05 + commission * 0.25 = '
    || TO_CHAR(salary * 0.05 + commission * 0.25)
  );
END;
```

/

Result:

```

5 + 12 / 4 = 8
12 / 4 + 5 = 8
8 + 6 / 2 = 11
(8 + 6) / 2 = 7
100 + (20 / 5 + (7 - 3)) = 108
(salary * 0.05) + (commission * 0.25) = 3000.025
salary * 0.05 + commission * 0.25 = 3000.025

```

2.7.3 Logical Operators

The logical operators **AND**, **OR**, and **NOT** follow a tri-state logic.

AND and **OR** are binary operators; **NOT** is a unary operator.

Table 2-4 Logical Truth Table

x	y	x AND y	x OR y	NOT x
TRUE	TRUE	TRUE	TRUE	FALSE
TRUE	FALSE	FALSE	TRUE	FALSE
TRUE	NULL	NULL	TRUE	FALSE
FALSE	TRUE	FALSE	TRUE	TRUE
FALSE	FALSE	FALSE	FALSE	TRUE
FALSE	NULL	FALSE	NULL	TRUE
NULL	TRUE	NULL	TRUE	NULL
NULL	FALSE	FALSE	NULL	NULL
NULL	NULL	NULL	NULL	NULL

AND returns **TRUE** if and only if both operands are **TRUE**.

OR returns **TRUE** if either operand is **TRUE**.

NOT returns the opposite of its operand, unless the operand is **NULL**. **NOTNULL** returns **NULL**, because **NULL** is an indeterminate value.

Example 2-34 Procedure Prints **BOOLEAN** Variable

This example creates a procedure, `print_boolean`, that prints the value of a **BOOLEAN** variable. The procedure uses the "[IS \[NOT\] NULL Operator](#)". Several examples in this chapter invoke `print_boolean`.

```

CREATE OR REPLACE PROCEDURE print_boolean (
  b_name  VARCHAR2,
  b_value BOOLEAN
) AUTHID DEFINER IS
BEGIN
  IF b_value IS NULL THEN
    DBMS_OUTPUT.PUT_LINE (b_name || ' = NULL');
  ELSIF b_value = TRUE THEN
    DBMS_OUTPUT.PUT_LINE (b_name || ' = TRUE');

```

```
ELSE
  DBMS_OUTPUT.PUT_LINE (b_name || ' = FALSE');
END IF;
END;
/
```

Example 2-35 AND Operator

As [Table 2-4](#) and this example show, AND returns TRUE if and only if both operands are TRUE.

```
DECLARE
  PROCEDURE print_x_and_y (
    x BOOLEAN,
    y BOOLEAN
  ) IS
  BEGIN
    print_boolean ('x', x);
    print_boolean ('y', y);
    print_boolean ('x AND y', x AND y);
  END print_x_and_y;

BEGIN
  print_x_and_y (FALSE, FALSE);
  print_x_and_y (TRUE, FALSE);
  print_x_and_y (FALSE, TRUE);
  print_x_and_y (TRUE, TRUE);

  print_x_and_y (TRUE, NULL);
  print_x_and_y (FALSE, NULL);
  print_x_and_y (NULL, TRUE);
  print_x_and_y (NULL, FALSE);
END;
/
```

Result:

```
x = FALSE
y = FALSE
x AND y = FALSE
x = TRUE
y = FALSE
x AND y = FALSE
x = FALSE
y = TRUE
x AND y = FALSE
x = TRUE
y = TRUE
x AND y = TRUE
x = TRUE
y = NULL
x AND y = NULL
x = FALSE
y = NULL
x AND y = FALSE
x = NULL
y = TRUE
x AND y = NULL
x = NULL
y = FALSE
x AND y = FALSE
```

Example 2-36 OR Operator

As [Table 2-4](#) and this example show, OR returns TRUE if either operand is TRUE. (This example invokes the `print_boolean` procedure from [Example 2-34](#).)

```
DECLARE
  PROCEDURE print_x_or_y (
    x BOOLEAN,
    y BOOLEAN
  ) IS
  BEGIN
    print_boolean ('x', x);
    print_boolean ('y', y);
    print_boolean ('x OR y', x OR y);
  END print_x_or_y;

BEGIN
  print_x_or_y (FALSE, FALSE);
  print_x_or_y (TRUE, FALSE);
  print_x_or_y (FALSE, TRUE);
  print_x_or_y (TRUE, TRUE);

  print_x_or_y (TRUE, NULL);
  print_x_or_y (FALSE, NULL);
  print_x_or_y (NULL, TRUE);
  print_x_or_y (NULL, FALSE);
END;
```

Result:

```
x = FALSE
y = FALSE
x OR y = FALSE
x = TRUE
y = FALSE
x OR y = TRUE
x = FALSE
y = TRUE
x OR y = TRUE
x = TRUE
y = TRUE
x OR y = TRUE
x = TRUE
y = NULL
x OR y = TRUE
x = FALSE
y = NULL
x OR y = NULL
x = NULL
y = TRUE
x OR y = TRUE
x = NULL
y = FALSE
x OR y = NULL
```

Example 2-37 NOT Operator

As [Table 2-4](#) and this example show, `NOT` returns the opposite of its operand, unless the operand is `NULL`. `NOT NULL` returns `NULL`, because `NULL` is an indeterminate value. (This example invokes the `print_boolean` procedure from [Example 2-34](#).)

```
DECLARE
  PROCEDURE print_not_x (
    x BOOLEAN
  ) IS
  BEGIN
    print_boolean ('x', x);
    print_boolean ('NOT x', NOT x);
  END print_not_x;

BEGIN
  print_not_x (TRUE);
  print_not_x (FALSE);
  print_not_x (NULL);
END;
```

Result:

```
x = TRUE
NOT x = FALSE
x = FALSE
NOT x = TRUE
x = NULL
NOT x = NULL
```

Example 2-38 NULL Value in Unequal Comparison

In this example, you might expect the sequence of statements to run because `x` and `y` seem unequal. But, `NULL` values are indeterminate. Whether `x` equals `y` is unknown. Therefore, the `IF` condition yields `NULL` and the sequence of statements is bypassed.

```
DECLARE
  x NUMBER := 5;
  y NUMBER := NULL;
BEGIN
  IF x != y THEN -- yields NULL, not TRUE
    DBMS_OUTPUT.PUT_LINE('x != y'); -- not run
  ELSIF x = y THEN -- also yields NULL
    DBMS_OUTPUT.PUT_LINE('x = y');
  ELSE
    DBMS_OUTPUT.PUT_LINE
      ('Can''t tell if x and y are equal or not.');
```

Result:

```
Can't tell if x and y are equal or not.
```

Example 2-39 NULL Value in Equal Comparison

In this example, you might expect the sequence of statements to run because `a` and `b` seem equal. But, again, that is unknown, so the `IF` condition yields `NULL` and the sequence of statements is bypassed.

```
DECLARE
  a NUMBER := NULL;
  b NUMBER := NULL;
BEGIN
  IF a = b THEN -- yields NULL, not TRUE
    DBMS_OUTPUT.PUT_LINE('a = b'); -- not run
  ELSIF a != b THEN -- yields NULL, not TRUE
    DBMS_OUTPUT.PUT_LINE('a != b'); -- not run
  ELSE
    DBMS_OUTPUT.PUT_LINE('Can't tell if two NULLs are equal');
  END IF;
END;
/
```

Result:

```
Can't tell if two NULLs are equal
```

Example 2-40 NOT NULL Equals NULL

In this example, the two `IF` statements appear to be equivalent. However, if either `x` or `y` is `NULL`, then the first `IF` statement assigns the value of `y` to `high` and the second `IF` statement assigns the value of `x` to `high`.

```
DECLARE
  x INTEGER := 2;
  y INTEGER := 5;
  high INTEGER;
BEGIN
  IF (x > y) -- If x or y is NULL, then (x > y) is NULL
    THEN high := x; -- run if (x > y) is TRUE
    ELSE high := y; -- run if (x > y) is FALSE or NULL
  END IF;

  IF NOT (x > y) -- If x or y is NULL, then NOT (x > y) is NULL
    THEN high := y; -- run if NOT (x > y) is TRUE
    ELSE high := x; -- run if NOT (x > y) is FALSE or NULL
  END IF;
END;
/
```

Example 2-41 Changing Evaluation Order of Logical Operators

This example invokes the `print_boolean` procedure from [Example 2-34](#) three times. The third and first invocation are logically equivalent—the parentheses in the third invocation only improve readability. The parentheses in the second invocation change the order of operation.

```
DECLARE
  x BOOLEAN := FALSE;
  y BOOLEAN := FALSE;
BEGIN
  print_boolean ('NOT x AND y', NOT x AND y);
```



```
print_boolean ('NOT (x AND y)', NOT (x AND y));
print_boolean ('(NOT x) AND y', (NOT x) AND y);
END;
/
```

Result:

```
NOT x AND y = FALSE
NOT (x AND y) = TRUE
(NOT x) AND y = FALSE
```

2.7.4 Short-Circuit Evaluation

When evaluating a logical expression, PL/SQL uses **short-circuit evaluation**. That is, PL/SQL stops evaluating the expression as soon as it can determine the result.

Therefore, you can write expressions that might otherwise cause errors.

In [Example 2-42](#), short-circuit evaluation prevents the `OR` expression from causing a divide-by-zero error. When the value of `on_hand` is zero, the value of the left operand is `TRUE`, so PL/SQL does not evaluate the right operand. If PL/SQL evaluated both operands before applying the `OR` operator, the right operand would cause a division by zero error.

Example 2-42 Short-Circuit Evaluation

```
DECLARE
  on_hand INTEGER := 0;
  on_order INTEGER := 100;
BEGIN
  -- Does not cause divide-by-zero error;
  -- evaluation stops after first expression

  IF (on_hand = 0) OR ((on_order / on_hand) < 5) THEN
    DBMS_OUTPUT.PUT_LINE('On hand quantity is zero.');
```

Result:

```
On hand quantity is zero.
```

2.7.5 Comparison Operators

Comparison operators compare one expression to another. The result is always either `TRUE`, `FALSE`, or `NULL`.

If the value of one expression is `NULL`, then the result of the comparison is also `NULL`.

The comparison operators are:

- [IS \[NOT\] NULL Operator](#)
- [Relational Operators](#)
- [LIKE Operator](#)
- [BETWEEN Operator](#)

- [IN Operator](#)

 **Note:**

Character comparisons are affected by NLS parameter settings, which can change at runtime. Therefore, character comparisons are evaluated at runtime, and the same character comparison can have different values at different times. For information about NLS parameters that affect character comparisons, see *Oracle Database Globalization Support Guide*.

 **Note:**

Using CLOB values with comparison operators can create temporary LOB values. Ensure that your temporary tablespace is large enough to handle them.

2.7.5.1 IS [NOT] NULL Operator

The `IS NULL` operator returns the `BOOLEAN` value `TRUE` if its operand is `NULL` or `FALSE` if it is not `NULL`. The `IS NOT NULL` operator does the opposite.

Comparisons involving `NULL` values always yield `NULL`.

To test whether a value is `NULL`, use `IF value IS NULL`, as in these examples:

- [Example 2-14](#), "Variable Initialized to `NULL` by Default"
- [Example 2-34](#), "Procedure Prints `BOOLEAN` Variable"
- [Example 2-53](#), "Searched `CASE` Expression with `WHEN ... IS NULL`"

2.7.5.2 Relational Operators

This table summarizes the relational operators.

Table 2-5 Relational Operators

Operator	Meaning
=	equal to
<>, !=, ~=, ^=	not equal to
<	less than
>	greater than
<=	less than or equal to
>=	greater than or equal to

Topics

- [Arithmetic Comparisons](#)

- [BOOLEAN Comparisons](#)
- [Character Comparisons](#)
- [Date Comparisons](#)

2.7.5.2.1 Arithmetic Comparisons

One number is greater than another if it represents a larger quantity.

Real numbers are stored as approximate values, so Oracle recommends comparing them for equality or inequality.

Example 2-43 Relational Operators in Expressions

This example invokes the `print_boolean` procedure from [Example 2-35](#) to print the values of expressions that use relational operators to compare arithmetic values.

```
BEGIN
  print_boolean ('(2 + 2 = 4)', 2 + 2 = 4);

  print_boolean ('(2 + 2 <> 4)', 2 + 2 <> 4);
  print_boolean ('(2 + 2 != 4)', 2 + 2 != 4);
  print_boolean ('(2 + 2 ~= 4)', 2 + 2 ~= 4);
  print_boolean ('(2 + 2 ^= 4)', 2 + 2 ^= 4);

  print_boolean ('(1 < 2)', 1 < 2);

  print_boolean ('(1 > 2)', 1 > 2);

  print_boolean ('(1 <= 2)', 1 <= 2);

  print_boolean ('(1 >= 1)', 1 >= 1);
END;
/
```

Result:

```
(2 + 2 = 4) = TRUE
(2 + 2 <> 4) = FALSE
(2 + 2 != 4) = FALSE
(2 + 2 ~= 4) = FALSE
(2 + 2 ^= 4) = FALSE
(1 < 2) = TRUE
(1 > 2) = FALSE
(1 <= 2) = TRUE
(1 >= 1) = TRUE
```

2.7.5.2.2 BOOLEAN Comparisons

By definition, `TRUE` is greater than `FALSE`. Any comparison with `NULL` returns `NULL`.

2.7.5.2.3 Character Comparisons

By default, one character is greater than another if its binary value is larger.

For example, this expression is true:

```
'y' > 'r'
```

Strings are compared character by character. For example, this expression is true:

```
'Kathy' > 'Kathryn'
```

If you set the initialization parameter `NLS_COMP=ANSI`, string comparisons use the collating sequence identified by the `NLS_SORT` initialization parameter.

A **collating sequence** is an internal ordering of the character set in which a range of numeric codes represents the individual characters. One character value is greater than another if its internal numeric value is larger. Each language might have different rules about where such characters occur in the collating sequence. For example, an accented letter might be sorted differently depending on the database character set, even though the binary value is the same in each case.

By changing the value of the `NLS_SORT` parameter, you can perform comparisons that are case-insensitive and accent-insensitive.

A **case-insensitive comparison** treats corresponding uppercase and lowercase letters as the same letter. For example, these expressions are true:

```
'a' = 'A'  
'Alpha' = 'ALPHA'
```

To make comparisons case-insensitive, append `_CI` to the value of the `NLS_SORT` parameter (for example, `BINARY_CI` or `XGERMAN_CI`).

An **accent-insensitive comparison** is case-insensitive, and also treats letters that differ only in accents or punctuation characters as the same letter. For example, these expressions are true:

```
'Cooperate' = 'Co-Operate'  
'Co-Operate' = 'coöperate'
```

To make comparisons both case-insensitive and accent-insensitive, append `_AI` to the value of the `NLS_SORT` parameter (for example, `BINARY_AI` or `FRENCH_M_AI`).

Semantic differences between the `CHAR` and `VARCHAR2` data types affect character comparisons.

For more information, see "[Value Comparisons](#)".

2.7.5.2.4 Date Comparisons

One date is greater than another if it is more recent.

For example, this expression is true:

```
'01-JAN-91' > '31-DEC-90'
```

2.7.5.3 LIKE Operator

The `LIKE` operator compares a character, string, or `CLOB` value to a pattern and returns `TRUE` if the value matches the pattern and `FALSE` if it does not.

Case is significant.

The pattern can include the two **wildcard characters** underscore (`_`) and percent sign (`%`).

Underscore matches exactly one character.

Percent sign (%) matches zero or more characters.

To search for the percent sign or underscore, define an escape character and put it before the percent sign or underscore.

See Also:

- *Oracle Database SQL Language Reference* for more information about `LIKE`
- *Oracle Database SQL Language Reference* for information about `REGEXP_LIKE`, which is similar to `LIKE`

Example 2-44 LIKE Operator in Expression

The string 'Johnson' matches the pattern 'J%s_n' but not 'J%S_N', as this example shows.

```
DECLARE
  PROCEDURE compare (
    value  VARCHAR2,
    pattern VARCHAR2
  ) IS
  BEGIN
    IF value LIKE pattern THEN
      DBMS_OUTPUT.PUT_LINE ('TRUE');
    ELSE
      DBMS_OUTPUT.PUT_LINE ('FALSE');
    END IF;
  END;
BEGIN
  compare('Johnson', 'J%s_n');
  compare('Johnson', 'J%S_N');
END;
/
```

Result:

```
TRUE
FALSE
```

Example 2-45 Escape Character in Pattern

This example uses the backslash as the escape character, so that the percent sign in the string does not act as a wildcard.

```
DECLARE
  PROCEDURE half_off (sale_sign VARCHAR2) IS
  BEGIN
    IF sale_sign LIKE '50\% off!' ESCAPE '\' THEN
      DBMS_OUTPUT.PUT_LINE ('TRUE');
    ELSE
      DBMS_OUTPUT.PUT_LINE ('FALSE');
    END IF;
  END;
BEGIN
  half_off('Going out of business!');
  half_off('50% off!');
END;
```

/

Result:FALSE
TRUE

2.7.5.4 BETWEEN Operator

The `BETWEEN` operator tests whether a value lies in a specified range.

The value of the expression `x BETWEEN a AND b` is defined to be the same as the value of the expression `(x>=a) AND (x<=b)`. The expression `x` will only be evaluated once.



See Also:

Oracle Database SQL Language Reference for more information about `BETWEEN`

Example 2-46 BETWEEN Operator in Expressions

This example invokes the `print_boolean` procedure from [Example 2-34](#) to print the values of expressions that include the `BETWEEN` operator.

```
BEGIN
  print_boolean ('2 BETWEEN 1 AND 3', 2 BETWEEN 1 AND 3);
  print_boolean ('2 BETWEEN 2 AND 3', 2 BETWEEN 2 AND 3);
  print_boolean ('2 BETWEEN 1 AND 2', 2 BETWEEN 1 AND 2);
  print_boolean ('2 BETWEEN 3 AND 4', 2 BETWEEN 3 AND 4);
END;
/
```

Result:

```
2 BETWEEN 1 AND 3 = TRUE
2 BETWEEN 2 AND 3 = TRUE
2 BETWEEN 1 AND 2 = TRUE
2 BETWEEN 3 AND 4 = FALSE
```

2.7.5.5 IN Operator

The `IN` operator tests set membership.

`x IN (set)` returns `TRUE` only if `x` equals a member of `set`.



See Also:

Oracle Database SQL Language Reference for more information about `IN`

Example 2-47 IN Operator in Expressions

This example invokes the `print_boolean` procedure from [Example 2-34](#) to print the values of expressions that include the `IN` operator.

```
DECLARE
  letter VARCHAR2(1) := 'm';
BEGIN
  print_boolean (
    'letter IN (''a'', ''b'', ''c'')',
    letter IN ('a', 'b', 'c')
  );
  print_boolean (
    'letter IN (''z'', ''m'', ''y'', ''p'')',
    letter IN ('z', 'm', 'y', 'p')
  );
END;
/
```

Result:

```
letter IN ('a', 'b', 'c') = FALSE
letter IN ('z', 'm', 'y', 'p') = TRUE
```

Example 2-48 IN Operator with Sets with NULL Values

This example shows what happens when `set` includes a `NULL` value. This invokes the `print_boolean` procedure from [Example 2-34](#).

```
DECLARE
  a INTEGER; -- Initialized to NULL by default
  b INTEGER := 10;
  c INTEGER := 100;
BEGIN
  print_boolean ('100 IN (a, b, c)', 100 IN (a, b, c));
  print_boolean ('100 NOT IN (a, b, c)', 100 NOT IN (a, b, c));

  print_boolean ('100 IN (a, b)', 100 IN (a, b));
  print_boolean ('100 NOT IN (a, b)', 100 NOT IN (a, b));

  print_boolean ('a IN (a, b)', a IN (a, b));
  print_boolean ('a NOT IN (a, b)', a NOT IN (a, b));
END;
/
```

Result:

```
100 IN (a, b, c) = TRUE
100 NOT IN (a, b, c) = FALSE
100 IN (a, b) = NULL
100 NOT IN (a, b) = NULL
a IN (a, b) = NULL
a NOT IN (a, b) = NULL
```

2.7.6 BOOLEAN Expressions

A **BOOLEAN expression** is an expression that returns a **BOOLEAN value**—`TRUE`, `FALSE`, or `NULL`.

The simplest `BOOLEAN` expression is a `BOOLEAN` literal, constant, or variable. The following are also `BOOLEAN` expressions:

```
NOT boolean_expression
boolean_expression relational_operator boolean_expression
boolean_expression { AND | OR } boolean_expression
```

For a list of relational operators, see [Table 2-5](#). For the complete syntax of a `BOOLEAN` expression, see "[boolean_expression ::=](#)".

Typically, you use `BOOLEAN` expressions as conditions in control statements (explained in [PL/SQL Control Statements](#)) and in `WHERE` clauses of DML statements.

You can use a `BOOLEAN` variable itself as a condition; you need not compare it to the value `TRUE` or `FALSE`.

Example 2-49 Equivalent `BOOLEAN` Expressions

In this example, the conditions in the loops are equivalent.

```
DECLARE
  done BOOLEAN;
BEGIN
  -- These WHILE loops are equivalent

  done := FALSE;
  WHILE done = FALSE
  LOOP
    done := TRUE;
  END LOOP;

  done := FALSE;
  WHILE NOT (done = TRUE)
  LOOP
    done := TRUE;
  END LOOP;

  done := FALSE;
  WHILE NOT done
  LOOP
    done := TRUE;
  END LOOP;
END;
/
```

2.7.7 CASE Expressions

Topics

- [Simple CASE Expression](#)
- [Searched CASE Expression](#)

2.7.7.1 Simple CASE Expression

For this explanation, assume that a simple `CASE` expression has this syntax:

```
CASE selector
WHEN selector_value_1 THEN result_1
WHEN selector_value_2 THEN result_2
```



```

...
WHEN selector_value_n THEN result_n
[ ELSE
  else_result ]
END

```

The *selector* is an expression (typically a single variable). Each *selector_value* and each *result* can be either a literal or an expression. At least one *result* must not be the literal `NULL`.

The simple `CASE` expression returns the first *result* for which *selector_value* matches *selector*. Remaining expressions are not evaluated. If no *selector_value* matches *selector*, the `CASE` expression returns *else_result* if it exists and `NULL` otherwise.



See Also:

"[simple_case_expression ::=](#)" for the complete syntax

Example 2-50 Simple CASE Expression

This example assigns the value of a simple `CASE` expression to the variable `appraisal`. The *selector* is `grade`.

```

DECLARE
  grade CHAR(1) := 'B';
  appraisal VARCHAR2(20);
BEGIN
  appraisal :=
    CASE grade
      WHEN 'A' THEN 'Excellent'
      WHEN 'B' THEN 'Very Good'
      WHEN 'C' THEN 'Good'
      WHEN 'D' THEN 'Fair'
      WHEN 'F' THEN 'Poor'
      ELSE 'No such grade'
    END;
  DBMS_OUTPUT.PUT_LINE ('Grade ' || grade || ' is ' || appraisal);
END;
/

```

Result:

```
Grade B is Very Good
```

Example 2-51 Simple CASE Expression with WHEN NULL

If *selector* has the value `NULL`, it cannot be matched by `WHEN NULL`, as this example shows.

Instead, use a searched `CASE` expression with `WHEN boolean_expression IS NULL`, as in [Example 2-53](#).

```

DECLARE
  grade CHAR(1); -- NULL by default
  appraisal VARCHAR2(20);
BEGIN
  appraisal :=

```

```

CASE grade
  WHEN NULL THEN 'No grade assigned'
  WHEN 'A' THEN 'Excellent'
  WHEN 'B' THEN 'Very Good'
  WHEN 'C' THEN 'Good'
  WHEN 'D' THEN 'Fair'
  WHEN 'F' THEN 'Poor'
  ELSE 'No such grade'
END;
DBMS_OUTPUT.PUT_LINE ('Grade ' || grade || ' is ' || appraisal);
END;
/

```

Result:

Grade is **No such grade**

2.7.7.2 Searched CASE Expression

For this explanation, assume that a searched CASE expression has this syntax:

```

CASE
  WHEN boolean_expression_1 THEN result_1
  WHEN boolean_expression_2 THEN result_2
  ...
  WHEN boolean_expression_n THEN result_n
  [ ELSE
    else_result ]
END]

```

The searched CASE expression returns the first *result* for which *boolean_expression* is TRUE. Remaining expressions are not evaluated. If no *boolean_expression* is TRUE, the CASE expression returns *else_result* if it exists and NULL otherwise.



See Also:

"[searched_case_expression ::=](#)" for the complete syntax

Example 2-52 Searched CASE Expression

This example assigns the value of a searched CASE expression to the variable appraisal.

```

DECLARE
  grade      CHAR(1) := 'B';
  appraisal  VARCHAR2(120);
  id         NUMBER := 8429862;
  attendance NUMBER := 150;
  min_days   CONSTANT NUMBER := 200;

  FUNCTION attends_this_school (id NUMBER)
    RETURN BOOLEAN IS
  BEGIN
    RETURN TRUE;
  END;
BEGIN
  appraisal :=

```

```

CASE
  WHEN attends_this_school(id) = FALSE
    THEN 'Student not enrolled'
  WHEN grade = 'F' OR attendance < min_days
    THEN 'Poor (poor performance or bad attendance)'
  WHEN grade = 'A' THEN 'Excellent'
  WHEN grade = 'B' THEN 'Very Good'
  WHEN grade = 'C' THEN 'Good'
  WHEN grade = 'D' THEN 'Fair'
  ELSE 'No such grade'
END;
DBMS_OUTPUT.PUT_LINE
('Result for student ' || id || ' is ' || appraisal);
END;
/

```

Result:

Result for student 8429862 is Poor (poor performance or bad attendance)

Example 2-53 Searched CASE Expression with WHEN ... IS NULL

This example uses a searched CASE expression to solve the problem in [Example 2-51](#).

```

DECLARE
  grade CHAR(1); -- NULL by default
  appraisal VARCHAR2(20);
BEGIN
  appraisal :=
    CASE
      WHEN grade IS NULL THEN 'No grade assigned'
      WHEN grade = 'A' THEN 'Excellent'
      WHEN grade = 'B' THEN 'Very Good'
      WHEN grade = 'C' THEN 'Good'
      WHEN grade = 'D' THEN 'Fair'
      WHEN grade = 'F' THEN 'Poor'
      ELSE 'No such grade'
    END;
  DBMS_OUTPUT.PUT_LINE ('Grade ' || grade || ' is ' || appraisal);
END;
/

```

Result:

Grade is No grade assigned

2.7.8 SQL Functions in PL/SQL Expressions

In PL/SQL expressions, you can use all SQL functions except:

- Aggregate functions (such as `AVG` and `COUNT`)
- Analytic functions (such as `LAG` and `RATIO_TO_REPORT`)
- Data mining functions (such as `CLUSTER_ID` and `FEATURE_VALUE`)
- Encoding and decoding functions (such as `DECODE` and `DUMP`)
- Model functions (such as `ITERATION_NUMBER` and `PREVIOUS`)

- Object reference functions (such as `REF` and `VALUE`)
- XML functions
- These conversion functions:
 - `BIN_TO_NUM`
- These JSON SQL operators:
 - `JSON_ARRAYAGG`
 - `JSON_EQUAL`
 - `JSON_OBJECTAGG`
 - `JSON_TABLE`
 - `JSON_TEXTCONTAINS`
- These collation SQL operators and functions:
 - `COLLATE`
 - `COLLATION`
 - `NLS_COLLATION_ID`
 - `NLS_COLLATION_NAME`
- These miscellaneous functions:
 - `CUBE_TABLE`
 - `DATAOBJ_TO_PARTITION`
 - `LNNVL`
 - `NVL2`
 - `SYS_CONNECT_BY_PATH`
 - `SYS_TYPEID`
 - `WIDTH_BUCKET`

PL/SQL supports an overload of `BITAND` for which the arguments and result are `BINARY_INTEGER`.

When used in a PL/SQL expression, the `RAWTOHEX` function accepts an argument of data type `RAW` and returns a `VARCHAR2` value with the hexadecimal representation of bytes that comprise the value of the argument. Arguments of types other than `RAW` can be specified only if they can be implicitly converted to `RAW`. This conversion is possible for `CHAR`, `VARCHAR2`, and `LONG` values that are valid arguments of the `HEXTORAW` function, and for `LONG RAW` and `BLOB` values of up to 16380 bytes.

2.7.9 Static Expressions

A **static expression** is an expression whose value can be determined at compile time—that is, it does not include character comparisons, variables, or function invocations. Static expressions are the only expressions that can appear in conditional compilation directives.

Definition of Static Expression

- An expression is static if it is the NULL literal.
- An expression is static if it is a character, numeric, or boolean literal.
- An expression is static if it is a reference to a static constant.
- An expression is static if it is a reference to a conditional compilation variable begun with \$\$.
- An expression is static if it is an operator is allowed in static expressions, if all of its operands are static, and if the operator does not raise an exception when it is evaluated on those operands.

Table 2-6 Operators Allowed in Static Expressions

Operators	Operators Category
()	Expression delimiter
**	exponentiation
*, /, +, -	Arithmetic operators for multiplication, division, addition or positive, subtraction or negative
=, !=, <, <=, >=, > IS [NOT] NULL	Comparison operators
NOT	Logical operator
[NOT] LIKE, [NOT] LIKE2, [NOT] LIKE4, [NOT] LIKEC	Pattern matching operators
XOR	Binary operator

This list shows functions allowed in static expressions.

- ABS
- ACOS
- ASCII
- ASCIISTR
- ASIN
- ATAN
- ATAN2
- BITAND
- CEIL
- CHR
- COMPOSE
- CONVERT
- COS
- COSH
- DECOMPOSE
- EXP

- FLOOR
- HEXTORAW
- INSTR
- INSTRB
- INSTRC
- INSTR2
- INSTR4
- IS [NOT] INFINITE
- IS [NOT] NAN
- LENGTH
- LENGTH2
- LENGTH4
- LENGTHB
- LENGTHC
- LN
- LOG
- LOWER
- LPAD
- LTRIM
- MOD
- NVL
- POWER
- RAWTOHEX
- REM
- REMAINDER
- REPLACE
- ROUND
- RPAD
- RTRIM
- SIGN
- SIN
- SINH
- SQRT
- SUBSTR
- SUBSTR2
- SUBSTR4
- SUBSTRB

- SUBSTRC
- TAN
- TANH
- TO_BINARY_DOUBLE
- TO_BINARY_FLOAT
- TO_CHAR
- TO_NUMBER
- TRIM
- TRUNC
- UPPER

Static expressions can be used in the following subtype declarations:

- Length of string types (`VARCHAR2`, `NCHAR`, `CHAR`, `NVARCHAR2`, `RAW`, and the ANSI equivalents)
- Scale and precision of `NUMBER` types and subtypes such as `FLOAT`
- Interval type precision (year, month ,second)
- Time and Timestamp precision
- `VARRAY` bounds
- Bounds of ranges in type declarations

In each case, the resulting type of the static expression must be the same as the declared item subtype and must be in the correct range for the context.

Topics

- [PLS_INTEGER Static Expressions](#)
- [BOOLEAN Static Expressions](#)
- [VARCHAR2 Static Expressions](#)
- [Static Constants](#)



See Also:

["Expressions"](#) for general information about expressions

2.7.9.1 PLS_INTEGER Static Expressions

`PLS_INTEGER` static expressions are:

- `PLS_INTEGER` literals
For information about literals, see ["Literals"](#).
- `PLS_INTEGER` static constants
For information about static constants, see ["Static Constants"](#).

- NULL

**See Also:**

"[PLS_INTEGER and BINARY_INTEGER Data Types](#)" for information about the `PLS_INTEGER` data type

2.7.9.2 BOOLEAN Static Expressions

BOOLEAN static expressions are:

- BOOLEAN literals (`TRUE`, `FALSE`, or `NULL`)
- BOOLEAN static constants

For information about static constants, see "[Static Constants](#)".

- Where x and y are `PLS_INTEGER` static expressions:

- $x > y$
- $x < y$
- $x \geq y$
- $x \leq y$
- $x = y$
- $x \lt \gt y$

For information about `PLS_INTEGER` static expressions, see "[PLS_INTEGER Static Expressions](#)".

- Where x and y are `BOOLEAN` expressions:

- NOT y
- x AND y
- x OR y
- $x > y$
- $x \geq y$
- $x = y$
- $x \leq y$
- $x \lt \gt y$

For information about `BOOLEAN` expressions, see "[BOOLEAN Expressions](#)".

- Where x is a static expression:

- x IS NULL
- x IS NOT NULL

For information about static expressions, see "[Static Expressions](#)".

**See Also:**

"[BOOLEAN Data Type](#)" for information about the `BOOLEAN` data type

2.7.9.3 VARCHAR2 Static Expressions

`VARCHAR2` static expressions are:

- String literal with maximum size of 32,767 bytes
For information about literals, see "[Literals](#)".
- `NULL`
- `TO_CHAR(x)`, where `x` is a `PLS_INTEGER` static expression
For information about the `TO_CHAR` function, see *Oracle Database SQL Language Reference*.
- `TO_CHAR(x, f, n)` where `x` is a `PLS_INTEGER` static expression and `f` and `n` are `VARCHAR2` static expressions
For information about the `TO_CHAR` function, see *Oracle Database SQL Language Reference*.
- `x || y` where `x` and `y` are `VARCHAR2` or `PLS_INTEGER` static expressions
For information about `PLS_INTEGER` static expressions, see "[PLS_INTEGER Static Expressions](#)".

**See Also:**

"[CHAR and VARCHAR2 Variables](#)" for information about the `VARCHAR2` data type

2.7.9.4 Static Constants

A **static constant** is declared in a package specification with this syntax:

```
constant_name CONSTANT data_type := static_expression;
```

The type of `static_expression` must be the same as `data_type` (either `BOOLEAN` or `PLS_INTEGER`).

The static constant must always be referenced as `package_name.constant_name`, even in the body of the `package_name` package.

If you use `constant_name` in the `BOOLEAN` expression in a conditional compilation directive in a PL/SQL unit, then the PL/SQL unit depends on the package `package_name`. If you alter the package specification, the dependent PL/SQL unit might become invalid and need recompilation (for information about the invalidation of dependent objects, see *Oracle Database Development Guide*).

If you use a package with static constants to control conditional compilation in multiple PL/SQL units, Oracle recommends that you create only the package specification, and

dedicate it exclusively to controlling conditional compilation. This practice minimizes invalidations caused by altering the package specification.

To control conditional compilation in a single PL/SQL unit, you can set flags in the `PLSQL_CCFLAGS` compilation parameter. For information about this parameter, see ["Assigning Values to Inquiry Directives"](#) and *Oracle Database Reference*.

See Also:

- ["Declaring Constants"](#) for general information about declaring constants
- [PL/SQL Packages](#) for more information about packages
- *Oracle Database Development Guide* for more information about schema object dependencies

Example 2-54 Static Constants

In this example, the package `my_debug` defines the static constants `debug` and `trace` to control debugging and tracing in multiple PL/SQL units. The procedure `my_proc1` uses only `debug`, and the procedure `my_proc2` uses only `trace`, but both procedures depend on the package. However, the recompiled code might not be different. For example, if you only change the value of `debug` to `FALSE` and then recompile the two procedures, the compiled code for `my_proc1` changes, but the compiled code for `my_proc2` does not.

```
CREATE PACKAGE my_debug IS
  debug CONSTANT BOOLEAN := TRUE;
  trace CONSTANT BOOLEAN := TRUE;
END my_debug;
/

CREATE PROCEDURE my_proc1 AUTHID DEFINER IS
BEGIN
  $IF my_debug.debug $THEN
    DBMS_OUTPUT.put_line('Debugging ON');
  $ELSE
    DBMS_OUTPUT.put_line('Debugging OFF');
  $END
END my_proc1;
/

CREATE PROCEDURE my_proc2 AUTHID DEFINER IS
BEGIN
  $IF my_debug.trace $THEN
    DBMS_OUTPUT.put_line('Tracing ON');
  $ELSE
    DBMS_OUTPUT.put_line('Tracing OFF');
  $END
END my_proc2;
/
```

2.8 Error-Reporting Functions

PL/SQL has two error-reporting functions, `SQLCODE` and `SQLERRM`, for use in PL/SQL exception-handling code.

For their descriptions, see "[SQLCODE Function](#)" and "[SQLERRM Function](#)".

You cannot use the `SQLCODE` and `SQLERRM` functions in SQL statements.

2.9 Conditional Compilation

Conditional compilation lets you customize the functionality of a PL/SQL application without removing source text.

For example, you can:

- Use new features with the latest database release and disable them when running the application in an older database release.
- Activate debugging or tracing statements in the development environment and hide them when running the application at a production site.

Topics

- [How Conditional Compilation Works](#)
- [Conditional Compilation Examples](#)
- [Retrieving and Printing Post-Processed Source Text](#)
- [Conditional Compilation Directive Restrictions](#)

2.9.1 How Conditional Compilation Works

Conditional compilation uses selection directives, which are similar to `IF` statements, to select source text for compilation.

The condition in a selection directive usually includes an inquiry directive. Error directives raise user-defined errors. All conditional compilation directives are built from preprocessor control tokens and PL/SQL text.

Topics

- [Preprocessor Control Tokens](#)
- [Selection Directives](#)
- [Error Directives](#)
- [Inquiry Directives](#)
- [DBMS_DB_VERSION Package](#)



See Also:

["Static Expressions"](#)

2.9.1.1 Preprocessor Control Tokens

A preprocessor control token identifies code that is processed before the PL/SQL unit is compiled.

Syntax

```
$plsql_identifier
```

There cannot be space between `$` and *plsql_identifier*.

The character `$` can also appear inside *plsql_identifier*, but it has no special meaning there.

These preprocessor control tokens are reserved:

- `$IF`
- `$THEN`
- `$ELSE`
- `$ELSIF`
- `$ERROR`

For information about *plsql_identifier*, see "[Identifiers](#)".

2.9.1.2 Selection Directives

A **selection directive** selects source text to compile.

Syntax

```
$IF boolean_static_expression $THEN
    text
[ $ELSIF boolean_static_expression $THEN
    text
]...
[ $ELSE
    text
$END
]
```

For the syntax of *boolean_static_expression*, see "[BOOLEAN Static Expressions](#)". The *text* can be anything, but typically, it is either a statement (see "[statement ::=](#)") or an error directive (explained in "[Error Directives](#)").

The selection directive evaluates the `BOOLEAN` static expressions in the order that they appear until either one expression has the value `TRUE` or the list of expressions is exhausted. If one expression has the value `TRUE`, its text is compiled, the remaining expressions are not evaluated, and their text is not analyzed. If no expression has the value `TRUE`, then if `$ELSE` is present, its text is compiled; otherwise, no text is compiled.

For examples of selection directives, see "[Conditional Compilation Examples](#)".

**See Also:**

"[Conditional Selection Statements](#)" for information about the `IF` statement, which has the same logic as the selection directive

2.9.1.3 Error Directives

An **error directive** produces a user-defined error message during compilation.

Syntax

```
$ERROR varchar2_static_expression $END
```

It produces this compile-time error message, where *string* is the value of *varchar2_static_expression*:

```
PLS-00179: $ERROR: string
```

For the syntax of *varchar2_static_expression*, see "[VARCHAR2 Static Expressions](#)".

For an example of an error directive, see [Example 2-58](#).

2.9.1.4 Inquiry Directives

An **inquiry directive** provides information about the compilation environment.

Syntax

```
$$name
```

For information about *name*, which is an unquoted PL/SQL identifier, see "[Identifiers](#)".

An inquiry directive typically appears in the *boolean_static_expression* of a selection directive, but it can appear anywhere that a variable or literal of its type can appear. Moreover, it can appear where regular PL/SQL allows only a literal (not a variable)—for example, to specify the size of a `VARCHAR2` variable.

Topics

- [Predefined Inquiry Directives](#)
- [Assigning Values to Inquiry Directives](#)
- [Unresolvable Inquiry Directives](#)

2.9.1.4.1 Predefined Inquiry Directives

The predefined inquiry directives are:

- `$$PLSQL_LINE`

A `PLS_INTEGER` literal whose value is the number of the source line on which the directive appears in the current PL/SQL unit. An example of `$$PLSQL_LINE` in a selection directive is:

```
$IF $$PLSQL_LINE = 32 $THEN ...
```

- `$$PLSQL_UNIT`
A `VARCHAR2` literal that contains the name of the current PL/SQL unit. If the current PL/SQL unit is an anonymous block, then `$$PLSQL_UNIT` contains a `NULL` value.
- `$$PLSQL_UNIT_OWNER`
A `VARCHAR2` literal that contains the name of the owner of the current PL/SQL unit. If the current PL/SQL unit is an anonymous block, then `$$PLSQL_UNIT_OWNER` contains a `NULL` value.
- `$$PLSQL_UNIT_TYPE`
A `VARCHAR2` literal that contains the type of the current PL/SQL unit—`ANONYMOUS BLOCK`, `FUNCTION`, `PACKAGE`, `PACKAGE BODY`, `PROCEDURE`, `TRIGGER`, `TYPE`, or `TYPE BODY`. Inside an anonymous block or non-DML trigger, `$$PLSQL_UNIT_TYPE` has the value `ANONYMOUS BLOCK`.
- `$$plsql_compilation_parameter`
The name `plsql_compilation_parameter` is a PL/SQL compilation parameter (for example, `PLSCOPE_SETTINGS`). For descriptions of these parameters, see [Table 1-2](#).

Because a selection directive needs a `BOOLEAN` static expression, you cannot use `$$PLSQL_UNIT`, `$$PLSQL_UNIT_OWNER`, or `$$PLSQL_UNIT_TYPE` in a `VARCHAR2` comparison such as:

```

$IF $$PLSQL_UNIT = 'AWARD_BONUS' $THEN ...
$IF $$PLSQL_UNIT_OWNER IS HR $THEN ...
$IF $$PLSQL_UNIT_TYPE IS FUNCTION $THEN ...

```

However, you can compare the preceding directives to `NULL`. For example:

```

$IF $$PLSQL_UNIT IS NULL $THEN ...
$IF $$PLSQL_UNIT_OWNER IS NOT NULL $THEN ...
$IF $$PLSQL_UNIT_TYPE IS NULL $THEN ...

```

Example 2-55 Predefined Inquiry Directives

In this example, a SQL*Plus script, uses several predefined inquiry directives as `PLS_INTEGER` and `VARCHAR2` literals to show how their values are assigned.

```

SQL> CREATE OR REPLACE PROCEDURE p
2 AUTHID DEFINER IS
3   i PLS_INTEGER;
4 BEGIN
5   DBMS_OUTPUT.PUT_LINE('Inside p');
6   i := $$PLSQL_LINE;
7   DBMS_OUTPUT.PUT_LINE('i = ' || i);
8   DBMS_OUTPUT.PUT_LINE('$$PLSQL_LINE = ' || $$PLSQL_LINE);
9   DBMS_OUTPUT.PUT_LINE('$$PLSQL_UNIT = ' || $$PLSQL_UNIT);
10  DBMS_OUTPUT.PUT_LINE('$$PLSQL_UNIT_OWNER = ' || $$PLSQL_UNIT_OWNER);
11  DBMS_OUTPUT.PUT_LINE('$$PLSQL_UNIT_TYPE = ' || $$PLSQL_UNIT_TYPE);
12 END;
13 /

```

Procedure created.

```

SQL> BEGIN
2   p;
3   DBMS_OUTPUT.PUT_LINE('Outside p');

```

```

4  DBMS_OUTPUT.PUT_LINE('$$PLSQL_LINE = ' || $$PLSQL_LINE);
5  DBMS_OUTPUT.PUT_LINE('$$PLSQL_UNIT = ' || $$PLSQL_UNIT);
6  DBMS_OUTPUT.PUT_LINE('$$PLSQL_UNIT_OWNER = ' || $$PLSQL_UNIT_OWNER);
7  DBMS_OUTPUT.PUT_LINE('$$PLSQL_UNIT_TYPE = ' || $$PLSQL_UNIT_TYPE);
8  END;
9  /

```

Result:

```

Inside p
i = 6
$$PLSQL_LINE = 8
$$PLSQL_UNIT = P
$$PLSQL_UNIT_OWNER = HR
$$PLSQL_UNIT_TYPE = PROCEDURE
Outside p
$$PLSQL_LINE = 4
$$PLSQL_UNIT =
$$PLSQL_UNIT_OWNER =
$$PLSQL_UNIT_TYPE = ANONYMOUS BLOCK

```

PL/SQL procedure successfully completed.

Example 2-56 Displaying Values of PL/SQL Compilation Parameters

This example displays the current values of PL/SQL the compilation parameters.

 **Note:**

In the SQL*Plus environment, you can display the current values of initialization parameters, including the PL/SQL compilation parameters, with the command `SHOW PARAMETERS`. For more information about the `SHOW` command and its `PARAMETERS` option, see *SQL*Plus User's Guide and Reference*.

```

BEGIN
  DBMS_OUTPUT.PUT_LINE('$$PLSCOPE_SETTINGS = ' || $$PLSCOPE_SETTINGS);
  DBMS_OUTPUT.PUT_LINE('$$PLSQL_CCFLAGS = ' || $$PLSQL_CCFLAGS);
  DBMS_OUTPUT.PUT_LINE('$$PLSQL_CODE_TYPE = ' || $$PLSQL_CODE_TYPE);
  DBMS_OUTPUT.PUT_LINE('$$PLSQL_OPTIMIZE_LEVEL = ' || $$PLSQL_OPTIMIZE_LEVEL);
  DBMS_OUTPUT.PUT_LINE('$$PLSQL_WARNINGS = ' || $$PLSQL_WARNINGS);
  DBMS_OUTPUT.PUT_LINE('$$NLS_LENGTH_SEMANTICS = ' || $$NLS_LENGTH_SEMANTICS);
END;
/

```

Result:

```

$$PLSCOPE_SETTINGS = IDENTIFIERS:NONE
$$PLSQL_CCFLAGS =
$$PLSQL_CODE_TYPE = INTERPRETED
$$PLSQL_OPTIMIZE_LEVEL = 2
$$PLSQL_WARNINGS = ENABLE:ALL
$$NLS_LENGTH_SEMANTICS = BYTE

```

2.9.1.4.2 Assigning Values to Inquiry Directives

You can assign values to inquiry directives with the `PLSQL_CCFLAGS` compilation parameter.

For example:

```
ALTER SESSION SET PLSQL_CCFLAGS =  
  'name1:value1, name2:value2, ... namen:valuen'
```

Each *value* must be either a `BOOLEAN` literal (`TRUE`, `FALSE`, or `NULL`) or `PLS_INTEGER` literal. The data type of *value* determines the data type of *name*.

The same *name* can appear multiple times, with values of the same or different data types. Later assignments override earlier assignments. For example, this command sets the value of `$$flag` to 5 and its data type to `PLS_INTEGER`:

```
ALTER SESSION SET PLSQL_CCFLAGS = 'flag:TRUE, flag:5'
```

Oracle recommends against using `PLSQL_CCFLAGS` to assign values to predefined inquiry directives, including compilation parameters. To assign values to compilation parameters, Oracle recommends using the `ALTER SESSION` statement.

For more information about the `ALTER SESSION` statement, see *Oracle Database SQL Language Reference*.

Note:

The compile-time value of `PLSQL_CCFLAGS` is stored with the metadata of stored PL/SQL units, which means that you can reuse the value when you explicitly recompile the units. For more information, see "[PL/SQL Units and Compilation Parameters](#)".

For more information about `PLSQL_CCFLAGS`, see *Oracle Database Reference*.

Example 2-57 PLSQL_CCFLAGS Assigns Value to Itself

This example uses `PLSQL_CCFLAGS` to assign a value to the user-defined inquiry directive `$$Some_Flag` and (though not recommended) to itself. Because later assignments override earlier assignments, the resulting value of `$$Some_Flag` is 2 and the resulting value of `PLSQL_CCFLAGS` is the value that it assigns to itself (99), not the value that the `ALTER SESSION` statement assigns to it ('Some_Flag:1, Some_Flag:2, PLSQL_CCFlags:99').

```
ALTER SESSION SET  
PLSQL_CCFlags = 'Some_Flag:1, Some_Flag:2, PLSQL_CCFlags:99'  
/  
BEGIN  
  DBMS_OUTPUT.PUT_LINE($$Some_Flag);  
  DBMS_OUTPUT.PUT_LINE($$PLSQL_CCFlags);  
END;  
/
```

Result:

2.9.1.4.3 Unresolvable Inquiry Directives

If the source text is not wrapped, PL/SQL issues a warning if the value of an inquiry directive cannot be determined.

If an inquiry directive (`$$name`) cannot be resolved, and the source text is not wrapped, then PL/SQL issues the warning `PLW-6003` and substitutes `NULL` for the value of the unresolved inquiry directive. If the source text is wrapped, the warning message is disabled, so that the unresolved inquiry directive is not revealed.

For information about wrapping PL/SQL source text, see [PL/SQL Source Text Wrapping](#).

2.9.1.5 DBMS_DB_VERSION Package

The `DBMS_DB_VERSION` package specifies the Oracle version numbers and other information useful for simple conditional compilation selections based on Oracle versions.

The `DBMS_DB_VERSION` package provides these static constants:

- The `PLS_INTEGER` constant `VERSION` identifies the current Oracle Database version.
- The `PLS_INTEGER` constant `RELEASE` identifies the current Oracle Database release number.
- Each `BOOLEAN` constant of the form `VER_LE_v` has the value `TRUE` if the database version is less than or equal to `v`; otherwise, it has the value `FALSE`.
- Each `BOOLEAN` constant of the form `VER_LE_v_r` has the value `TRUE` if the database version is less than or equal to `v` and release is less than or equal to `r`; otherwise, it has the value `FALSE`.

For more information about the `DBMS_DB_VERSION` package, see *Oracle Database PL/SQL Packages and Types Reference*.

2.9.2 Conditional Compilation Examples

Examples of conditional compilation using selection and user-defined inquiry directives.

Example 2-58 Code for Checking Database Version

This example generates an error message if the database version and release is less than Oracle Database 10g release 2; otherwise, it displays a message saying that the version and release are supported and uses a `COMMIT` statement that became available at Oracle Database 10g release 2.

```
BEGIN
  $IF DBMS_DB_VERSION.VER_LE_10_1 $THEN -- selection directive begins
    $ERROR 'unsupported database release' $END -- error directive
  $ELSE
    DBMS_OUTPUT.PUT_LINE (
      'Release ' || DBMS_DB_VERSION.VERSION || '.' ||
      DBMS_DB_VERSION.RELEASE || ' is supported.'
    );
    -- This COMMIT syntax is newly supported in 10.2:
    COMMIT WRITE IMMEDIATE NOWAIT;
  $END -- selection directive ends
```

```
END;
/
```

Result:

Release 12.1 is supported.

Example 2-59 Compiling Different Code for Different Database Versions

This example sets the values of the user-defined inquiry directives `$$my_debug` and `$$my_tracing` and then uses conditional compilation:

- In the specification of package `my_pkg`, to determine the base type of the subtype `my_real` (`BINARY_DOUBLE` is available only for Oracle Database versions 10g and later.)
- In the body of package `my_pkg`, to compute the values of `my_pi` and `my_e` differently for different database versions
- In the procedure `circle_area`, to compile some code only if the inquiry directive `$$my_debug` has the value `TRUE`.

```
ALTER SESSION SET PLSQL_CCFLAGS = 'my_debug:FALSE, my_tracing:FALSE';

CREATE OR REPLACE PACKAGE my_pkg AUTHID DEFINER AS
  SUBTYPE my_real IS
    $IF DBMS_DB_VERSION.VERSION < 10 $THEN
      NUMBER;
    $ELSE
      BINARY_DOUBLE;
    $END

    my_pi my_real;
    my_e my_real;
  END my_pkg;
/

CREATE OR REPLACE PACKAGE BODY my_pkg AS
  BEGIN
    $IF DBMS_DB_VERSION.VERSION < 10 $THEN
      my_pi := 3.14159265358979323846264338327950288420;
      my_e := 2.71828182845904523536028747135266249775;
    $ELSE
      my_pi := 3.14159265358979323846264338327950288420d;
      my_e := 2.71828182845904523536028747135266249775d;
    $END
  END my_pkg;
/

CREATE OR REPLACE PROCEDURE circle_area(radius my_pkg.my_real) AUTHID DEFINER IS
  my_area my_pkg.my_real;
  my_data_type VARCHAR2(30);
  BEGIN
    my_area := my_pkg.my_pi * (radius**2);

    DBMS_OUTPUT.PUT_LINE
      ('Radius: ' || TO_CHAR(radius) || ' Area: ' || TO_CHAR(my_area));

    $IF $$my_debug $THEN
      SELECT DATA_TYPE INTO my_data_type
```

```

FROM USER_ARGUMENTS
WHERE OBJECT_NAME = 'CIRCLE_AREA'
AND ARGUMENT_NAME = 'RADIUS';

DBMS_OUTPUT.PUT_LINE
('Data type of the RADIUS argument is: ' || my_data_type);
$END
END;
/

CALL DBMS_PREPROCESSOR.PRINT_POST_PROCESSED_SOURCE
('PACKAGE', 'HR', 'MY_PKG');

```

Result:

```

PACKAGE my_pkg AUTHID DEFINER AS
SUBTYPE my_real IS
BINARY_DOUBLE;
my_pi my_real;
my_e my_real;
END my_pkg;

```

Call completed.

2.9.3 Retrieving and Printing Post-Processed Source Text

The `DBMS_PREPROCESSOR` package provides subprograms that retrieve and print the source text of a PL/SQL unit in its post-processed form.

For information about the `DBMS_PREPROCESSOR` package, see *Oracle Database PL/SQL Packages and Types Reference*.

Example 2-60 Displaying Post-Processed Source Text

This example invokes the procedure `DBMS_PREPROCESSOR.PRINT_POST_PROCESSED_SOURCE` to print the post-processed form of `my_pkg` (from "Example 2-59"). Lines of code in "Example 2-59" that are not included in the post-processed text appear as blank lines.

```

CALL DBMS_PREPROCESSOR.PRINT_POST_PROCESSED_SOURCE (
  'PACKAGE', 'HR', 'MY_PKG'
);

```

Result:

```

PACKAGE my_pkg AUTHID DEFINERs AS
SUBTYPE my_real IS
BINARY_DOUBLE;
my_pi my_real;
my_e my_real;
END my_pkg;

```

2.9.4 Conditional Compilation Directive Restrictions

Conditional compilation directives are subject to these semantic restrictions.

A conditional compilation directive cannot appear in the specification of a schema-level user-defined type (created with the "CREATE TYPE Statement"). This type specification specifies the attribute structure of the type, which determines the attribute structure of dependent types and the column structure of dependent tables.

 **Caution:**

Using a conditional compilation directive to change the attribute structure of a type can cause dependent objects to "go out of sync" or dependent tables to become inaccessible. Oracle recommends that you change the attribute structure of a type only with the "[ALTER TYPE Statement](#)". The `ALTER TYPE` statement propagates changes to dependent objects.

If a conditional compilation directive is used in a schema-level type specification, the compiler raises the error `PLS-00180: preprocessor directives are not supported in this context`.

As all conditional compiler constructs are processed by the PL/SQL preprocessor, the SQL Parser imposes the following restrictions on the location of the first conditional compilation directive in a stored PL/SQL unit or anonymous block:

- In a package specification, a package body, a type body, a schema-level function and in a schema-level procedure, at least one nonwhitespace PL/SQL token must appear after the identifier of the unit name before a conditional compilation directive is valid.

 **Note:**

- The PL/SQL comments, "--" or "/*", are counted as whitespace tokens.
- If the token is invalid in PL/SQL, then a `PLS-00103` error is issued. But if a conditional compilation directive is used in violation of this rule, then an `ORA` error is produced.

[Example 2-61](#) and [Example 2-62](#), show that the first conditional compilation directive appears after the first PL/SQL token that follows the identifier of the unit being defined.

- In a trigger or an anonymous block, the first conditional compilation directive cannot appear before the keyword `DECLARE` or `BEGIN`, whichever comes first.

The SQL parser also imposes this restriction: If an anonymous block uses a placeholder, the placeholder cannot appear in a conditional compilation directive. For example:

```
BEGIN
  :n := 1; -- valid use of placeholder
  $IF ... $THEN
    :n := 1; -- invalid use of placeholder
$END
```

Example 2-61 Using Conditional Compilation Directive in the Definition of a Package Specification

This example shows the placement of the first conditional compilation directive after an `AUTHID` clause, but before the keyword `IS`, in the definition of the package specification.

```
CREATE OR REPLACE PACKAGE cc_pkg
AUTHID DEFINER
$IF $$XFLAG $THEN ACCESSIBLE BY (p1_pkg) $END
IS
    i NUMBER := 10;
    trace CONSTANT BOOLEAN := TRUE;
END cc_pkg;
```

Result:

Package created.

Example 2-62 Using Conditional Compilation Directive in the Formal Parameter List of a Subprogram

This example shows the placement of the first conditional compilation directive after the left parenthesis, in the formal parameter list of a PL/SQL procedure definition.

```
CREATE OR REPLACE PROCEDURE my_proc (
    $IF $$xxx $THEN i IN PLS_INTEGER $ELSE i IN INTEGER $END
) IS
BEGIN
    NULL;
END my_proc;
```

Result:

Procedure created.

3

PL/SQL Data Types

Every PL/SQL constant, variable, parameter, and function return value has a **data type** that determines its storage format and its valid values and operations.

This chapter explains **scalar data types**, which store values with no internal components.

A scalar data type can have subtypes. A **subtype** is a data type that is a subset of another data type, which is its **base type**. A subtype has the same valid operations as its base type. A data type and its subtypes comprise a **data type family**.

PL/SQL predefines many types and subtypes in the package `STANDARD` and lets you define your own subtypes.

The PL/SQL scalar data types are:

- The SQL data types
- `BOOLEAN`
- `PLS_INTEGER`
- `BINARY_INTEGER`
- `REF CURSOR`
- User-defined subtypes

Topics

- [SQL Data Types](#)
- [BOOLEAN Data Type](#)
- [PLS_INTEGER and BINARY_INTEGER Data Types](#)
- [SIMPLE_INTEGER Subtype of PLS_INTEGER](#)
- [User-Defined PL/SQL Subtypes](#)

See Also:

- ["PL/SQL Collections and Records"](#) for information about **composite data types**
- ["Cursor Variables"](#) for information about `REF CURSOR`
- ["CREATE TYPE Statement"](#) for information about creating schema-level user-defined data types
- ["PL/SQL Predefined Data Types"](#) for the predefined PL/SQL data types and subtypes, grouped by data type family

3.1 SQL Data Types

The PL/SQL data types include the SQL data types.

For information about the SQL data types, see *Oracle Database SQL Language Reference*—all information there about data types and subtypes, data type comparison rules, data conversion, literals, and format models applies to both SQL and PL/SQL, except as noted here:

- [Different Maximum Sizes](#)
- [Additional PL/SQL Constants for BINARY_FLOAT and BINARY_DOUBLE](#)
- [Additional PL/SQL Subtypes of BINARY_FLOAT and BINARY_DOUBLE](#)

Unlike SQL, PL/SQL lets you declare variables, to which the following topics apply:

- [CHAR and VARCHAR2 Variables](#)
- [LONG and LONG RAW Variables](#)
- [ROWID and UROWID Variables](#)

3.1.1 Different Maximum Sizes

The SQL data types listed in [Table 3-1](#) have different maximum sizes in PL/SQL and SQL.

Table 3-1 Data Types with Different Maximum Sizes in PL/SQL and SQL

Data Type	Maximum Size in PL/SQL	Maximum Size in SQL
CHAR ¹	32,767 bytes	2,000 bytes
NCHAR ¹	32,767 bytes	2,000 bytes
RAW ¹	32,767 bytes	2,000 bytes ²
VARCHAR2 ¹	32,767 bytes	4,000 bytes ²
NVARCHAR2 ¹	32,767 bytes	4,000 bytes ²
LONG ³	32,760 bytes	2 gigabytes (GB) - 1
LONG RAW ³	32,760 bytes	2 GB
BLOB	128 terabytes (TB)	(4 GB - 1) * <i>database_block_size</i>
CLOB	128 TB	(4 GB - 1) * <i>database_block_size</i>
NCLOB	128 TB	(4 GB - 1) * <i>database_block_size</i>

¹ When specifying the maximum size of a value of this data type in PL/SQL, use an integer literal (not a constant or variable) whose value is in the range from 1 through 32,767.

² To eliminate this size difference, follow the instructions in *Oracle Database SQL Language Reference*.

³ Supported only for backward compatibility with existing applications.

3.1.2 Additional PL/SQL Constants for BINARY_FLOAT and BINARY_DOUBLE

The SQL data types `BINARY_FLOAT` and `BINARY_DOUBLE` represent single-precision and double-precision IEEE 754-format floating-point numbers, respectively.

`BINARY_FLOAT` and `BINARY_DOUBLE` computations do not raise exceptions, so you must check the values that they produce for conditions such as overflow and underflow by comparing them to predefined constants (for examples, see *Oracle Database SQL Language Reference*). PL/SQL has more of these constants than SQL does.

[Table 3-2](#) lists and describes the predefined PL/SQL constants for `BINARY_FLOAT` and `BINARY_DOUBLE`, and identifies those that SQL also defines.

Table 3-2 Predefined PL/SQL BINARY_FLOAT and BINARY_DOUBLE Constants

Constant	Description
<code>BINARY_FLOAT_NAN (*)</code>	<code>BINARY_FLOAT</code> value for which the condition <code>IS NAN</code> (not a number) is true
<code>BINARY_FLOAT_INFINITY (*)</code>	Single-precision positive infinity
<code>BINARY_FLOAT_MAX_NORMAL</code>	Maximum normal <code>BINARY_FLOAT</code> value
<code>BINARY_FLOAT_MIN_NORMAL</code>	Minimum normal <code>BINARY_FLOAT</code> value
<code>BINARY_FLOAT_MAX_SUBNORMAL</code>	Maximum subnormal <code>BINARY_FLOAT</code> value
<code>BINARY_FLOAT_MIN_SUBNORMAL</code>	Minimum subnormal <code>BINARY_FLOAT</code> value
<code>BINARY_DOUBLE_NAN (*)</code>	<code>BINARY_DOUBLE</code> value for which the condition <code>IS NAN</code> (not a number) is true
<code>BINARY_DOUBLE_INFINITY (*)</code>	Double-precision positive infinity
<code>BINARY_DOUBLE_MAX_NORMAL</code>	Maximum normal <code>BINARY_DOUBLE</code> value
<code>BINARY_DOUBLE_MIN_NORMAL</code>	Minimum normal <code>BINARY_DOUBLE</code> value
<code>BINARY_DOUBLE_MAX_SUBNORMAL</code>	Maximum subnormal <code>BINARY_DOUBLE</code> value
<code>BINARY_DOUBLE_MIN_SUBNORMAL</code>	Minimum subnormal <code>BINARY_DOUBLE</code> value

(*) SQL also predefines this constant.

3.1.3 Additional PL/SQL Subtypes of BINARY_FLOAT and BINARY_DOUBLE

PL/SQL predefines these subtypes:

- `SIMPLE_FLOAT`, a subtype of SQL data type `BINARY_FLOAT`
- `SIMPLE_DOUBLE`, a subtype of SQL data type `BINARY_DOUBLE`

Each subtype has the same range as its base type and has a `NOT NULL` constraint (explained in ["NOT NULL Constraint"](#)).

If you know that a variable will never have the value `NULL`, declare it as `SIMPLE_FLOAT` or `SIMPLE_DOUBLE`, rather than `BINARY_FLOAT` or `BINARY_DOUBLE`. Without the overhead of

checking for nullness, the subtypes provide significantly better performance than their base types. The performance improvement is greater with `PLSQL_CODE_TYPE='NATIVE'` than with `PLSQL_CODE_TYPE='INTERPRETED'` (for more information, see ["Use Data Types that Use Hardware Arithmetic"](#)).

3.1.4 CHAR and VARCHAR2 Variables

Topics

- [Assigning or Inserting Too-Long Values](#)
- [Declaring Variables for Multibyte Characters](#)
- [Differences Between CHAR and VARCHAR2 Data Types](#)

3.1.4.1 Assigning or Inserting Too-Long Values

If the value that you assign to a character variable is longer than the maximum size of the variable, an error occurs. For example:

```
DECLARE
  c VARCHAR2(3 CHAR);
BEGIN
  c := 'abc  ';
END;
/
```

Result:

```
DECLARE
*
ERROR at line 1:
ORA-06502: PL/SQL: numeric or value error: character string buffer too small
ORA-06512: at line 4
```

Similarly, if you insert a character variable into a column, and the value of the variable is longer than the defined width of the column, an error occurs. For example:

```
DROP TABLE t;
CREATE TABLE t (c CHAR(3 CHAR));

DECLARE
  s VARCHAR2(5 CHAR) := 'abc  ';
BEGIN
  INSERT INTO t(c) VALUES(s);
END;
/
```

Result:

```
BEGIN
*
ERROR at line 1:
ORA-12899: value too large for column "HR"."T"."C" (actual: 5, maximum: 3)
ORA-06512: at line 4
```

To strip trailing blanks from a character value before assigning it to a variable or inserting it into a column, use the `RTRIM` function, explained in *Oracle Database SQL Language Reference*. For example:

```

DECLARE
  c VARCHAR2(3 CHAR);
BEGIN
  c := RTRIM('abc ');
  INSERT INTO t(c) VALUES (RTRIM('abc '));
END;
/

```

Result:

PL/SQL procedure successfully completed.

3.1.4.2 Declaring Variables for Multibyte Characters

The maximum size of a `CHAR` or `VARCHAR2` variable is 32,767 bytes, whether you specify the maximum size in characters or bytes. The maximum *number of characters* in the variable depends on the character set type and sometimes on the characters themselves:

Character Set Type	Maximum Number of Characters
Single-byte character set	32,767
<i>n</i> -byte fixed-width multibyte character set (for example, AL16UTF16)	$\text{FLOOR}(32,767/n)$
<i>n</i> -byte variable-width multibyte character set with character widths between 1 and <i>n</i> bytes (for example, JA16SJIS or AL32UTF8)	Depends on characters themselves—can be anything from 32,767 (for a string containing only 1-byte characters) through $\text{FLOOR}(32,767/n)$ (for a string containing only <i>n</i> -byte characters).

When declaring a `CHAR` or `VARCHAR2` variable, to ensure that it can always hold *n* characters in any multibyte character set, declare its length in characters—that is, `CHAR(n CHAR)` or `VARCHAR2(n CHAR)`, where *n* does not exceed $\text{FLOOR}(32767/4) = 8191$.

**See Also:**

Oracle Database Globalization Support Guide for information about Oracle Database character set support

3.1.4.3 Differences Between CHAR and VARCHAR2 Data Types

`CHAR` and `VARCHAR2` data types differ in:

- [Predefined Subtypes](#)
- [How Blank-Padding Works](#)
- [Value Comparisons](#)

3.1.4.3.1 Predefined Subtypes

The `CHAR` data type has one predefined subtype in both PL/SQL and SQL—`CHARACTER`.

The `VARCHAR2` data type has one predefined subtype in both PL/SQL and SQL, `VARCHAR`, and an additional predefined subtype in PL/SQL, `STRING`.

Each subtype has the same range of values as its base type.

**Note:**

In a future PL/SQL release, to accommodate emerging SQL standards, `VARCHAR` might become a separate data type, no longer synonymous with `VARCHAR2`.

3.1.4.3.2 How Blank-Padding Works

This explains the differences and considerations of using blank-padding with `CHAR` and `VARCHAR2`.

Consider these situations:

- The value that you assign to a variable is shorter than the maximum size of the variable.
- The value that you insert into a column is shorter than the defined width of the column.
- The value that you retrieve from a column into a variable is shorter than the maximum size of the variable.

If the data type of the receiver is `CHAR`, PL/SQL blank-pads the value to the maximum size. Information about trailing blanks in the original value is lost.

If the data type of the receiver is `VARCHAR2`, PL/SQL neither blank-pads the value nor strips trailing blanks. Character values are assigned intact, and no information is lost.

Example 3-1 CHAR and VARCHAR2 Blank-Padding Difference

In this example, both the `CHAR` variable and the `VARCHAR2` variable have the maximum size of 10 characters. Each variable receives a five-character value with one trailing blank. The value assigned to the `CHAR` variable is blank-padded to 10 characters, and you cannot tell that one of the six trailing blanks in the resulting value was in the original value. The value assigned to the `VARCHAR2` variable is not changed, and you can see that it has one trailing blank.

```
DECLARE
  first_name  CHAR(10 CHAR);
  last_name   VARCHAR2(10 CHAR);
BEGIN
  first_name := 'John ';
  last_name  := 'Chen ';

  DBMS_OUTPUT.PUT_LINE('*' || first_name || '*');
  DBMS_OUTPUT.PUT_LINE('*' || last_name || '*');
END;
/
```

Result:

```
*John      *
*Chen     *
```

3.1.4.3.3 Value Comparisons

The SQL rules for comparing character values apply to PL/SQL character variables.

Whenever one or both values in the comparison have the data type `VARCHAR2` or `NVARCHAR2`, nonpadded comparison semantics apply; otherwise, blank-padded semantics apply. For more information, see *Oracle Database SQL Language Reference*.

3.1.5 LONG and LONG RAW Variables

Note:

Oracle supports the `LONG` and `LONG RAW` data types only for backward compatibility with existing applications. For new applications:

- Instead of `LONG`, use `VARCHAR2 (32760)`, `BLOB`, `CLOB` or `NCLOB`.
- Instead of `LONG RAW`, use `BLOB`.

You can insert any `LONG` value into a `LONG` column. You can insert any `LONG RAW` value into a `LONG RAW` column. You cannot retrieve a value longer than 32,760 bytes from a `LONG` or `LONG RAW` column into a `LONG` or `LONG RAW` variable.

You can insert any `CHAR` or `VARCHAR2` value into a `LONG` column. You cannot retrieve a value longer than 32,767 bytes from a `LONG` column into a `CHAR` or `VARCHAR2` variable.

You can insert any `RAW` value into a `LONG RAW` column. You cannot retrieve a value longer than 32,767 bytes from a `LONG RAW` column into a `RAW` variable.

See Also:

"[Trigger LONG and LONG RAW Data Type Restrictions](#)" for restrictions on `LONG` and `LONG RAW` data types in triggers

3.1.6 ROWID and UROWID Variables

When you retrieve a rowid into a `ROWID` variable, use the `ROWIDTOCHAR` function to convert the binary value to a character value. For information about this function, see *Oracle Database SQL Language Reference*.

To convert the value of a `ROWID` variable to a rowid, use the `CHARTOROWID` function, explained in *Oracle Database SQL Language Reference*. If the value does not represent a valid rowid, PL/SQL raises the predefined exception `SYS_INVALID_ROWID`.

To retrieve a rowid into a `UROWID` variable, or to convert the value of a `UROWID` variable to a rowid, use an assignment statement; conversion is implicit.

 **Note:**

- UROWID is a more versatile data type than ROWID, because it is compatible with both logical and physical rowids.
- When you update a row in a table compressed with Hybrid Columnar Compression (HCC), the ROWID of the row changes. HCC, a feature of certain Oracle storage systems, is described in *Oracle Database Concepts*.

 **See Also:**

Oracle Database PL/SQL Packages and Types Reference for information about the DBMS_ROWID package, whose subprograms let you create and return information about ROWID values (but not UROWID values)

3.2 BOOLEAN Data Type

The PL/SQL data type `BOOLEAN` stores **logical values**, which are the boolean values `TRUE` and `FALSE` and the value `NULL`. `NULL` represents an unknown value.

The syntax for declaring an `BOOLEAN` variable is:

```
variable_name BOOLEAN
```

The only value that you can assign to a `BOOLEAN` variable is a `BOOLEAN` expression. For details, see "[BOOLEAN Expressions](#)".

Because SQL has no data type equivalent to `BOOLEAN`, you cannot:

- Assign a `BOOLEAN` value to a database table column
- Select or fetch the value of a database table column into a `BOOLEAN` variable
- Use a `BOOLEAN` value in a SQL function

(However, a SQL query can invoke a PL/SQL function that has a `BOOLEAN` parameter, as in "[Example 3-3](#)".)

- Use a `BOOLEAN` expression in a SQL statement, except as an argument to a PL/SQL function invoked in a SQL query, or in a PL/SQL anonymous block.

 **Note:**

An argument to a PL/SQL function invoked in a static SQL query cannot be a `BOOLEAN` literal. The workaround is to assign the literal to a variable and then pass the variable to the function, as in "[Example 3-3](#)".

You cannot pass a `BOOLEAN` value to the `DBMS_OUTPUT.PUT` or `DBMS_OUTPUT.PUTLINE` subprogram. To print a `BOOLEAN` value, use an `IF` or `CASE` statement to translate it to a

character value (for information about these statements, see "[Conditional Selection Statements](#)").

Example 3-2 Printing BOOLEAN Values

In this example, the procedure accepts a `BOOLEAN` parameter and uses a `CASE` statement to print `Unknown` if the value of the parameter is `NULL`, `Yes` if it is `TRUE`, and `No` if it is `FALSE`.



See Also:

[Example 2-34](#), which creates a `print_boolean` procedure that uses an `IF` statement.

```
PROCEDURE print_boolean (b BOOLEAN)
AS
BEGIN
    DBMS_OUTPUT.PUT_LINE (
        CASE
            WHEN b IS NULL THEN 'Unknown'
            WHEN b THEN 'Yes'
            WHEN NOT b THEN 'No'
        END
    );
END;

BEGIN
    print_boolean(TRUE);
    print_boolean(FALSE);
    print_boolean(NULL);
END;
```

Result:

```
Yes
No
Unknown
```

Example 3-3 SQL Statement Invokes PL/SQL Function with BOOLEAN Parameter

In this example, a SQL statement invokes a PL/SQL function that has a `BOOLEAN` parameter.

```
FUNCTION f (x BOOLEAN, y PLS_INTEGER)
RETURN employees.employee_id%TYPE
AUTHID CURRENT_USER AS
BEGIN
    IF x THEN
        RETURN y;
    ELSE
        RETURN 2*y;
    END IF;
END;

DECLARE
    name employees.last_name%TYPE;
    b BOOLEAN := TRUE;
BEGIN
    SELECT last_name INTO name
    FROM employees
```

```

WHERE employee_id = f(b, 100);

DBMS_OUTPUT.PUT_LINE(name);

b := FALSE;

SELECT last_name INTO name
FROM employees
WHERE employee_id = f(b, 100);

DBMS_OUTPUT.PUT_LINE(name);
END;
/

```

Result:

```

King
Whalen

```

3.3 PLS_INTEGER and BINARY_INTEGER Data Types

The PL/SQL data types `PLS_INTEGER` and `BINARY_INTEGER` are identical.

For simplicity, this document uses `PLS_INTEGER` to mean both `PLS_INTEGER` and `BINARY_INTEGER`.

The `PLS_INTEGER` data type stores signed integers in the range -2,147,483,648 through 2,147,483,647, represented in 32 bits.

The `PLS_INTEGER` data type has these advantages over the `NUMBER` data type and `NUMBER` subtypes:

- `PLS_INTEGER` values require less storage.
- `PLS_INTEGER` operations use hardware arithmetic, so they are faster than `NUMBER` operations, which use library arithmetic.

For efficiency, use `PLS_INTEGER` values for all calculations in its range.

Topics

- [Preventing PLS_INTEGER Overflow](#)
- [Predefined PLS_INTEGER Subtypes](#)
- [SIMPLE_INTEGER Subtype of PLS_INTEGER](#)

3.3.1 Preventing PLS_INTEGER Overflow

A calculation with two `PLS_INTEGER` values that overflows the `PLS_INTEGER` range raises an overflow exception.

For calculations outside the `PLS_INTEGER` range, use `INTEGER`, a predefined subtype of the `NUMBER` data type.

Example 3-4 PLS_INTEGER Calculation Raises Overflow Exception

This example shows that a calculation with two `PLS_INTEGER` values that overflows the `PLS_INTEGER` range raises an overflow exception, even if you assign the result to a `NUMBER` data type.

```

DECLARE
  p1 PLS_INTEGER := 2147483647;
  p2 PLS_INTEGER := 1;
  n NUMBER;
BEGIN
  n := p1 + p2;
END;
/

```

Result:

```

DECLARE
*
ERROR at line 1:
ORA-01426: numeric overflow
ORA-06512: at line 6

```

Example 3-5 Preventing Example 3-4 Overflow

This example shows the correct use of the `INTEGER` predefined subtype for calculations outside the `PLS_INTEGER` range.

```

DECLARE
  p1 PLS_INTEGER := 2147483647;
  p2 INTEGER := 1;
  n NUMBER;
BEGIN
  n := p1 + p2;
END;
/

```

Result:

PL/SQL procedure successfully completed.

3.3.2 Predefined PLS_INTEGER Subtypes

This summary lists the predefined subtypes of the `PLS_INTEGER` data type and describes the data they store.

Table 3-3 Predefined Subtypes of PLS_INTEGER Data Type

Data Type	Data Description
NATURAL	Nonnegative <code>PLS_INTEGER</code> value
NATURALN	Nonnegative <code>PLS_INTEGER</code> value with <code>NOT NULL</code> constraint
POSITIVE	Positive <code>PLS_INTEGER</code> value
POSITIVEN	Positive <code>PLS_INTEGER</code> value with <code>NOT NULL</code> constraint
SIGNTYPE	<code>PLS_INTEGER</code> value -1, 0, or 1 (useful for programming tri-state logic)
SIMPLE_INTEGER	<code>PLS_INTEGER</code> value with <code>NOT NULL</code> constraint.

`PLS_INTEGER` and its subtypes can be implicitly converted to these data types:

- CHAR
- VARCHAR2

- NUMBER
- LONG

All of the preceding data types except LONG, and all PLS_INTEGER subtypes, can be implicitly converted to PLS_INTEGER.

A PLS_INTEGER value can be implicitly converted to a PLS_INTEGER subtype only if the value does not violate a constraint of the subtype.



See Also:

- ["NOT NULL Constraint"](#) for information about the NOT NULL constraint
- ["SIMPLE_INTEGER Subtype of PLS_INTEGER"](#) for more information about SIMPLE_INTEGER

Example 3-6 Violating Constraint of SIMPLE_INTEGER Subtype

This example shows that casting the PLS_INTEGER value NULL to the SIMPLE_INTEGER subtype raises an exception.

```
DECLARE
  a SIMPLE_INTEGER := 1;
  b PLS_INTEGER := NULL;
BEGIN
  a := b;
END;
/
```

Result:

```
DECLARE
*
ERROR at line 1:
ORA-06502: PL/SQL: numeric or value error
ORA-06512: at line 5
```

3.3.3 SIMPLE_INTEGER Subtype of PLS_INTEGER

SIMPLE_INTEGER is a predefined subtype of the PLS_INTEGER data type.

SIMPLE_INTEGER has the same range as PLS_INTEGER and has a NOT NULL constraint. It differs significantly from PLS_INTEGER in its overflow semantics.

If you know that a variable will never have the value NULL or need overflow checking, declare it as SIMPLE_INTEGER rather than PLS_INTEGER. Without the overhead of checking for nullness and overflow, SIMPLE_INTEGER performs significantly better than PLS_INTEGER.

Topics

- [SIMPLE_INTEGER Overflow Semantics](#)
- [Expressions with Both SIMPLE_INTEGER and Other Operands](#)
- [Integer Literals in SIMPLE_INTEGER Range](#)

**See Also:**["NOT NULL Constraint"](#)

3.3.3.1 SIMPLE_INTEGER Overflow Semantics

If and only if all operands in an expression have the data type `SIMPLE_INTEGER`, PL/SQL uses two's complement arithmetic and ignores overflows.

Because overflows are ignored, values can wrap from positive to negative or from negative to positive; for example:

$$2^{30} + 2^{30} = 0x40000000 + 0x40000000 = 0x80000000 = -2^{31}$$

$$-2^{31} + -2^{31} = 0x80000000 + 0x80000000 = 0x00000000 = 0$$

For example, this block runs without errors:

```
DECLARE
  n SIMPLE_INTEGER := 2147483645;
BEGIN
  FOR j IN 1..4 LOOP
    n := n + 1;
    DBMS_OUTPUT.PUT_LINE(TO_CHAR(n, 'S999999999'));
  END LOOP;
  FOR j IN 1..4 LOOP
    n := n - 1;
    DBMS_OUTPUT.PUT_LINE(TO_CHAR(n, 'S999999999'));
  END LOOP;
END;
/
```

Result:

```
+2147483646
+2147483647
-2147483648
-2147483647
-2147483648
+2147483647
+2147483646
+2147483645
```

PL/SQL procedure successfully completed.

3.3.3.2 Expressions with Both SIMPLE_INTEGER and Other Operands

If an expression has both `SIMPLE_INTEGER` and other operands, PL/SQL implicitly converts the `SIMPLE_INTEGER` values to `PLS_INTEGER NOT NULL`.

The PL/SQL compiler issues a warning when `SIMPLE_INTEGER` and other values are mixed in a way that might negatively impact performance by inhibiting some optimizations.

3.3.3.3 Integer Literals in SIMPLE_INTEGER Range

Integer literals in the `SIMPLE_INTEGER` range have the data type `SIMPLE_INTEGER`.

However, to ensure backward compatibility, when all operands in an arithmetic expression are integer literals, PL/SQL treats the integer literals as if they were cast to `PLS_INTEGER`.

3.4 User-Defined PL/SQL Subtypes

PL/SQL lets you define your own subtypes.

The base type can be any scalar or user-defined PL/SQL data type specifier such as `CHAR`, `DATE`, or `RECORD` (including a previously defined user-defined subtype).



Note:

The information in this topic applies to both user-defined subtypes and the predefined subtypes listed in [PL/SQL Predefined Data Types](#).

Subtypes can:

- Provide compatibility with ANSI/ISO data types
- Show the intended use of data items of that type
- Detect out-of-range values

Topics

- [Unconstrained Subtypes](#)
- [Constrained Subtypes](#)
- [Subtypes with Base Types in Same Data Type Family](#)

3.4.1 Unconstrained Subtypes

An **unconstrained subtype** has the same set of values as its base type, so it is only another name for the base type.

Therefore, unconstrained subtypes of the same base type are interchangeable with each other and with the base type. No data type conversion occurs.

To define an unconstrained subtype, use this syntax:

```
SUBTYPE subtype_name IS base_type
```

For information about *subtype_name* and *base_type*, see [subtype](#).

An example of an unconstrained subtype, which PL/SQL predefines for compatibility with ANSI, is:

```
SUBTYPE "DOUBLE PRECISION" IS FLOAT
```

Example 3-7 User-Defined Unconstrained Subtypes Show Intended Use

In this example, the unconstrained subtypes `Balance` and `Counter` show the intended uses of data items of their types.

```

DECLARE
    SUBTYPE Balance IS NUMBER;

    checking_account      Balance(6,2);
    savings_account      Balance(8,2);
    certificate_of_deposit Balance(8,2);
    max_insured CONSTANT Balance(8,2) := 250000.00;

    SUBTYPE Counter IS NATURAL;

    accounts Counter := 1;
    deposits Counter := 0;
    withdrawals Counter := 0;
    overdrafts Counter := 0;

    PROCEDURE deposit (
        account IN OUT Balance,
        amount IN Balance
    ) IS
    BEGIN
        account := account + amount;
        deposits := deposits + 1;
    END;

BEGIN
    NULL;
END;
/

```

3.4.2 Constrained Subtypes

A **constrained subtype** has only a subset of the values of its base type.

If the base type lets you specify size, precision and scale, or a range of values, then you can specify them for its subtypes. The subtype definition syntax is:

```

SUBTYPE subtype_name IS base_type
    { precision [, scale ] | RANGE low_value .. high_value } [ NOT NULL ]

```

Otherwise, the only constraint that you can put on its subtypes is NOT NULL:

```

SUBTYPE subtype_name IS base_type [ NOT NULL ]

```



Note:

The only base types for which you can specify a range of values are `PLS_INTEGER` and its subtypes (both predefined and user-defined).

A constrained subtype can be implicitly converted to its base type, but the base type can be implicitly converted to the constrained subtype only if the value does not violate a constraint of the subtype.

A constrained subtype can be implicitly converted to another constrained subtype with the same base type only if the source value does not violate a constraint of the target subtype.

 See Also:

- "[subtype_definition ::=](#)" syntax diagram
- "[subtype](#)" semantic description
- "[Example 3-6](#)", "Violating Constraint of SIMPLE_INTEGER Subtype"
- "[Formal Parameters of Constrained Subtypes](#)"
- "[NOT NULL Constraint](#)"

Example 3-8 User-Defined Constrained Subtype Detects Out-of-Range Values

In this example, the constrained subtype `Balance` detects out-of-range values.

```
DECLARE
    SUBTYPE Balance IS NUMBER(8,2);

    checking_account Balance;
    savings_account  Balance;

BEGIN
    checking_account := 2000.00;
    savings_account  := 1000000.00;
END;
/
```

Result:

```
DECLARE
*
ERROR at line 1:
ORA-06502: PL/SQL: numeric or value error: number precision too large
ORA-06512: at line 9
```

Example 3-9 Implicit Conversion Between Constrained Subtypes with Same Base Type

In this example, the three constrained subtypes have the same base type. The first two subtypes can be implicitly converted to the third subtype, but not to each other.

```
DECLARE
    SUBTYPE Digit      IS PLS_INTEGER RANGE 0..9;
    SUBTYPE Double_digit IS PLS_INTEGER RANGE 10..99;
    SUBTYPE Under_100  IS PLS_INTEGER RANGE 0..99;

    d Digit      := 4;
    dd Double_digit := 35;
    u Under_100;

BEGIN
    u := d; -- Succeeds; Under_100 range includes Digit range
    u := dd; -- Succeeds; Under_100 range includes Double_digit range
    dd := d; -- Raises error; Double_digit range does not include Digit range
END;
/
```

Result:

```
DECLARE
*
ERROR at line 1:
ORA-06502: PL/SQL: numeric or value error
ORA-06512: at line 12
```

3.4.3 Subtypes with Base Types in Same Data Type Family

If two subtypes have different base types in the same data type family, then one subtype can be implicitly converted to the other only if the source value does not violate a constraint of the target subtype.

For the predefined PL/SQL data types and subtypes, grouped by data type family, see [PL/SQL Predefined Data Types](#).

Example 3-10 Implicit Conversion Between Subtypes with Base Types in Same Family

In this example, the subtypes `Word` and `Text` have different base types in the same data type family. The first assignment statement implicitly converts a `Word` value to `Text`. The second assignment statement implicitly converts a `Text` value to `Word`. The third assignment statement cannot implicitly convert the `Text` value to `Word`, because the value is too long.

```
DECLARE
  SUBTYPE Word IS CHAR(6);
  SUBTYPE Text IS VARCHAR2(15);

  verb      Word := 'run';
  sentence1 Text;
  sentence2 Text := 'Hurry!';
  sentence3 Text := 'See Tom run.';

BEGIN
  sentence1 := verb; -- 3-character value, 15-character limit
  verb := sentence2; -- 6-character value, 6-character limit
  verb := sentence3; -- 12-character value, 6-character limit
END;
/
```

Result:

```
DECLARE
*
ERROR at line 1:
ORA-06502: PL/SQL: numeric or value error: character string buffer too small
ORA-06512: at line 13
```

4

PL/SQL Control Statements

PL/SQL has three categories of control statements: conditional selection statements, loop statements and sequential control statements.

PL/SQL categories of control statements are:

- **Conditional selection statements**, which run different statements for different data values.
The conditional selection statements are `IF` and `CASE`.
- **Loop statements**, which run the same statements with a series of different data values.
The loop statements are the basic `LOOP`, `FOR LOOP`, and `WHILE LOOP`.
The `EXIT` statement transfers control to the end of a loop. The `CONTINUE` statement exits the current iteration of a loop and transfers control to the next iteration. Both `EXIT` and `CONTINUE` have an optional `WHEN` clause, where you can specify a condition.
- **Sequential control statements**, which are not crucial to PL/SQL programming.
The sequential control statements are `GOTO`, which goes to a specified statement, and `NULL`, which does nothing.

Topics

- [Conditional Selection Statements](#)
- [LOOP Statements](#)
- [Sequential Control Statements](#)

4.1 Conditional Selection Statements

The **conditional selection statements**, `IF` and `CASE`, run different statements for different data values.

The `IF` statement either runs or skips a sequence of one or more statements, depending on a condition. The `IF` statement has these forms:

- `IF THEN`
- `IF THEN ELSE`
- `IF THEN ELSIF`

The `CASE` statement chooses from a sequence of conditions, and runs the corresponding statement. The `CASE` statement has these forms:

- Simple, which evaluates a single expression and compares it to several potential values.
- Searched, which evaluates multiple conditions and chooses the first one that is true.

The `CASE` statement is appropriate when a different action is to be taken for each alternative.

Topics

- [IF THEN Statement](#)
- [IF THEN ELSE Statement](#)
- [IF THEN ELSIF Statement](#)
- [Simple CASE Statement](#)
- [Searched CASE Statement](#)

4.1.1 IF THEN Statement

The `IF THEN` statement either runs or skips a sequence of one or more statements, depending on a condition.

The `IF THEN` statement has this structure:

```
IF condition THEN
  statements
END IF;
```

If the *condition* is true, the *statements* run; otherwise, the `IF` statement does nothing.

For complete syntax, see "[IF Statement](#)".



Tip:

Avoid clumsy `IF` statements such as:

```
IF new_balance < minimum_balance THEN
  overdrawn := TRUE;
ELSE
  overdrawn := FALSE;
END IF;
```

Instead, assign the value of the `BOOLEAN` expression directly to a `BOOLEAN` variable:

```
overdrawn := new_balance < minimum_balance;
```

A `BOOLEAN` variable is either `TRUE`, `FALSE`, or `NULL`. Do not write:

```
IF overdrawn = TRUE THEN
  RAISE insufficient_funds;
END IF;
```

Instead, write:

```
IF overdrawn THEN
  RAISE insufficient_funds;
END IF;
```

Example 4-1 IF THEN Statement

In this example, the statements between `THEN` and `END IF` run if and only if the value of `sales` is greater than `quota+200`.

```
DECLARE
  PROCEDURE p (
    sales NUMBER,
    quota NUMBER,
    emp_id NUMBER
  )
  IS
    bonus    NUMBER := 0;
    updated  VARCHAR2(3) := 'No';
  BEGIN
    IF sales > (quota + 200) THEN
      bonus := (sales - quota)/4;

      UPDATE employees
      SET salary = salary + bonus
      WHERE employee_id = emp_id;

      updated := 'Yes';
    END IF;

    DBMS_OUTPUT.PUT_LINE (
      'Table updated? ' || updated || ', ' ||
      'bonus = ' || bonus || '.'
    );
  END p;
BEGIN
  p(10100, 10000, 120);
  p(10500, 10000, 121);
END;
/
```

Result:

```
Table updated? No, bonus = 0.
Table updated? Yes, bonus = 125.
```

4.1.2 IF THEN ELSE Statement

The `IF THEN ELSE` statement has this structure:

```
IF condition THEN
  statements
ELSE
  else_statements
END IF;
```

If the value of *condition* is true, the *statements* run; otherwise, the *else_statements* run.

IF statements can be nested, as in [Example 4-3](#).

For complete syntax, see "[IF Statement](#)".

Example 4-2 IF THEN ELSE Statement

In this example, the statement between `THEN` and `ELSE` runs if and only if the value of `sales` is greater than `quota+200`; otherwise, the statement between `ELSE` and `END IF` runs.

```
DECLARE
  PROCEDURE p (
    sales NUMBER,
    quota NUMBER,
    emp_id NUMBER
  )
  IS
    bonus NUMBER := 0;
  BEGIN
    IF sales > (quota + 200) THEN
      bonus := (sales - quota)/4;
    ELSE
      bonus := 50;
    END IF;

    DBMS_OUTPUT.PUT_LINE('bonus = ' || bonus);

    UPDATE employees
    SET salary = salary + bonus
    WHERE employee_id = emp_id;
  END p;
BEGIN
  p(10100, 10000, 120);
  p(10500, 10000, 121);
END;
/
```

Result:

```
bonus = 50
bonus = 125
```

Example 4-3 Nested IF THEN ELSE Statements

```
DECLARE
  PROCEDURE p (
    sales NUMBER,
    quota NUMBER,
    emp_id NUMBER
  )
  IS
    bonus NUMBER := 0;
  BEGIN
    IF sales > (quota + 200) THEN
      bonus := (sales - quota)/4;
    ELSE
      IF sales > quota THEN
        bonus := 50;
      ELSE
        bonus := 0;
      END IF;
    END IF;

    DBMS_OUTPUT.PUT_LINE('bonus = ' || bonus);
```

```
UPDATE employees
SET salary = salary + bonus
WHERE employee_id = emp_id;
END p;
BEGIN
p(10100, 10000, 120);
p(10500, 10000, 121);
p(9500, 10000, 122);
END;
/
```

Result:

```
bonus = 50
bonus = 125
bonus = 0
```

4.1.3 IF THEN ELSIF Statement

The IF THEN ELSIF statement has this structure:

```
IF condition_1 THEN
  statements_1
ELSIF condition_2 THEN
  statements_2
[ ELSIF condition_3 THEN
  statements_3
]...
[ ELSE
  else_statements
]
END IF;
```

The IF THEN ELSIF statement runs the first *statements* for which *condition* is true. Remaining conditions are not evaluated. If no *condition* is true, the *else_statements* run, if they exist; otherwise, the IF THEN ELSIF statement does nothing.

A single IF THEN ELSIF statement is easier to understand than a logically equivalent nested IF THEN ELSE statement:

```
-- IF THEN ELSIF statement

IF condition_1 THEN statements_1;
  ELSIF condition_2 THEN statements_2;
  ELSIF condition_3 THEN statement_3;
END IF;

-- Logically equivalent nested IF THEN ELSE statements

IF condition_1 THEN
  statements_1;
ELSE
  IF condition_2 THEN
    statements_2;
  ELSE
    IF condition_3 THEN
      statements_3;
    END IF;
  END IF;
END IF;
```

For complete syntax, see ["IF Statement"](#).

Example 4-4 IF THEN ELSIF Statement

In this example, when the value of `sales` is larger than 50000, both the first and second conditions are true. However, because the first condition is true, `bonus` is assigned the value 1500, and the second condition is never tested. After `bonus` is assigned the value 1500, control passes to the `DBMS_OUTPUT.PUT_LINE` invocation.

```
DECLARE
  PROCEDURE p (sales NUMBER)
  IS
    bonus NUMBER := 0;
  BEGIN
    IF sales > 50000 THEN
      bonus := 1500;
    ELSIF sales > 35000 THEN
      bonus := 500;
    ELSE
      bonus := 100;
    END IF;

    DBMS_OUTPUT.PUT_LINE (
      'Sales = ' || sales || ', bonus = ' || bonus || '.'
    );
  END p;
BEGIN
  p(55000);
  p(40000);
  p(30000);
END;
/
```

Result:

```
Sales = 55000, bonus = 1500.
Sales = 40000, bonus = 500.
Sales = 30000, bonus = 100.
```

Example 4-5 IF THEN ELSIF Statement Simulates Simple CASE Statement

This example uses an `IF THEN ELSIF` statement with many `ELSIF` clauses to compare a single value to many possible values. For this purpose, a simple `CASE` statement is clearer—see [Example 4-6](#).

```
DECLARE
  grade CHAR(1);
BEGIN
  grade := 'B';

  IF grade = 'A' THEN
    DBMS_OUTPUT.PUT_LINE('Excellent');
  ELSIF grade = 'B' THEN
    DBMS_OUTPUT.PUT_LINE('Very Good');
  ELSIF grade = 'C' THEN
    DBMS_OUTPUT.PUT_LINE('Good');
  ELSIF grade = 'D' THEN
    DBMS_OUTPUT.PUT_LINE('Fair');
  ELSIF grade = 'F' THEN
    DBMS_OUTPUT.PUT_LINE('Poor');
  ELSE
```

```

        DBMS_OUTPUT.PUT_LINE('No such grade');
    END IF;
END;
/

```

Result:

Very Good

4.1.4 Simple CASE Statement

The simple CASE statement has this structure:

```

CASE selector
WHEN selector_value_1 THEN statements_1
WHEN selector_value_2 THEN statements_2
...
WHEN selector_value_n THEN statements_n
[ ELSE
  else_statements ]
END CASE;]

```

The *selector* is an expression (typically a single variable). Each *selector_value* can be either a literal or an expression. (For complete syntax, see "[CASE Statement](#)".)

The simple CASE statement runs the first *statements* for which *selector_value* equals *selector*. Remaining conditions are not evaluated. If no *selector_value* equals *selector*, the CASE statement runs *else_statements* if they exist and raises the predefined exception `CASE_NOT_FOUND` otherwise.

[Example 4-6](#) uses a simple CASE statement to compare a single value to many possible values. The CASE statement in [Example 4-6](#) is logically equivalent to the IF THEN ELSIF statement in [Example 4-5](#).

Note:

As in a simple CASE expression, if the selector in a simple CASE statement has the value `NULL`, it cannot be matched by `WHEN NULL` (see [Example 2-51](#)). Instead, use a searched CASE statement with `WHEN condition IS NULL` (see [Example 2-53](#)).

Example 4-6 Simple CASE Statement

```

DECLARE
  grade CHAR(1);
BEGIN
  grade := 'B';

  CASE grade
    WHEN 'A' THEN DBMS_OUTPUT.PUT_LINE('Excellent');
    WHEN 'B' THEN DBMS_OUTPUT.PUT_LINE('Very Good');
    WHEN 'C' THEN DBMS_OUTPUT.PUT_LINE('Good');
    WHEN 'D' THEN DBMS_OUTPUT.PUT_LINE('Fair');
    WHEN 'F' THEN DBMS_OUTPUT.PUT_LINE('Poor');
    ELSE DBMS_OUTPUT.PUT_LINE('No such grade');
  END CASE;

```

```
END;
/
```

Result:

Very Good

4.1.5 Searched CASE Statement

The searched CASE statement has this structure:

```
CASE
WHEN condition_1 THEN statements_1
WHEN condition_2 THEN statements_2
...
WHEN condition_n THEN statements_n
[ ELSE
  else_statements ]
END CASE;]
```

The searched CASE statement runs the first *statements* for which *condition* is true. Remaining conditions are not evaluated. If no *condition* is true, the CASE statement runs *else_statements* if they exist and raises the predefined exception CASE_NOT_FOUND otherwise. (For complete syntax, see "CASE Statement".)

The searched CASE statement in [Example 4-7](#) is logically equivalent to the simple CASE statement in [Example 4-6](#).

In both [Example 4-7](#) and [Example 4-6](#), the ELSE clause can be replaced by an EXCEPTION part. [Example 4-8](#) is logically equivalent to [Example 4-7](#).

Example 4-7 Searched CASE Statement

```
DECLARE
  grade CHAR(1);
BEGIN
  grade := 'B';

  CASE
    WHEN grade = 'A' THEN DBMS_OUTPUT.PUT_LINE('Excellent');
    WHEN grade = 'B' THEN DBMS_OUTPUT.PUT_LINE('Very Good');
    WHEN grade = 'C' THEN DBMS_OUTPUT.PUT_LINE('Good');
    WHEN grade = 'D' THEN DBMS_OUTPUT.PUT_LINE('Fair');
    WHEN grade = 'F' THEN DBMS_OUTPUT.PUT_LINE('Poor');
    ELSE DBMS_OUTPUT.PUT_LINE('No such grade');
  END CASE;
END;
/
```

Result:

Very Good

Example 4-8 EXCEPTION Instead of ELSE Clause in CASE Statement

```
DECLARE
  grade CHAR(1);
BEGIN
```

```
grade := 'B';

CASE
  WHEN grade = 'A' THEN DBMS_OUTPUT.PUT_LINE('Excellent');
  WHEN grade = 'B' THEN DBMS_OUTPUT.PUT_LINE('Very Good');
  WHEN grade = 'C' THEN DBMS_OUTPUT.PUT_LINE('Good');
  WHEN grade = 'D' THEN DBMS_OUTPUT.PUT_LINE('Fair');
  WHEN grade = 'F' THEN DBMS_OUTPUT.PUT_LINE('Poor');
END CASE;
EXCEPTION
  WHEN CASE_NOT_FOUND THEN
    DBMS_OUTPUT.PUT_LINE('No such grade');
END;
/
```

Result:

Very Good

4.2 LOOP Statements

Loop statements run the same statements with a series of different values. The loop statements are:

- **Basic LOOP**
- **FOR LOOP**
- **Cursor FOR LOOP**
- **WHILE LOOP**

The statements that exit a loop are:

- **EXIT**
- **EXIT WHEN**

The statements that exit the current iteration of a loop are:

- **CONTINUE**
- **CONTINUE WHEN**

EXIT, **EXIT WHEN**, **CONTINUE**, and **CONTINUE WHEN** and can appear anywhere inside a loop, but not outside a loop. Oracle recommends using these statements instead of the "**GOTO Statement**", which can exit a loop or the current iteration of a loop by transferring control to a statement outside the loop. (A raised exception also exits a loop. For information about exceptions, see "[Overview of Exception Handling](#)".)

LOOP statements can be labeled, and **LOOP** statements can be nested. Labels are recommended for nested loops to improve readability. You must ensure that the label in the **END LOOP** statement matches the label at the beginning of the same loop statement (the compiler does not check).

Topics

- [Basic LOOP Statement](#)
- [EXIT Statement](#)

- [EXIT WHEN Statement](#)
- [CONTINUE Statement](#)
- [CONTINUE WHEN Statement](#)
- [FOR LOOP Statement](#)
- [WHILE LOOP Statement](#)

For information about the cursor `FOR LOOP`, see "[Processing Query Result Sets With Cursor FOR LOOP Statements](#)".

4.2.1 Basic LOOP Statement

The basic `LOOP` statement has this structure:

```
[ label ] LOOP
  statements
END LOOP [ label ];
```

With each iteration of the loop, the *statements* run and control returns to the top of the loop. To prevent an infinite loop, a statement or raised exception must exit the loop.



See Also:

["Basic LOOP Statement"](#)

4.2.2 EXIT Statement

The `EXIT` statement exits the current iteration of a loop unconditionally and transfers control to the end of either the current loop or an enclosing labeled loop.

In [Example 4-9](#), the `EXIT` statement inside the basic `LOOP` statement transfers control unconditionally to the end of the current loop.



See Also:

["EXIT Statement"](#)

Example 4-9 Basic LOOP Statement with EXIT Statement

```
DECLARE
  x NUMBER := 0;
BEGIN
  LOOP
    DBMS_OUTPUT.PUT_LINE ('Inside loop: x = ' || TO_CHAR(x));
    x := x + 1;
    IF x > 3 THEN
      EXIT;
    END IF;
  END LOOP;
  -- After EXIT, control resumes here
  DBMS_OUTPUT.PUT_LINE(' After loop: x = ' || TO_CHAR(x));
```



```
END;
/
```

Result:

```
Inside loop: x = 0
Inside loop: x = 1
Inside loop: x = 2
Inside loop: x = 3
After loop: x = 4
```

4.2.3 EXIT WHEN Statement

The `EXIT WHEN` statement exits the current iteration of a loop when the condition in its `WHEN` clause is true, and transfers control to the end of either the current loop or an enclosing labeled loop.

Each time control reaches the `EXIT WHEN` statement, the condition in its `WHEN` clause is evaluated. If the condition is not true, the `EXIT WHEN` statement does nothing. To prevent an infinite loop, a statement inside the loop must make the condition true, as in [Example 4-10](#).

In [Example 4-10](#), the `EXIT WHEN` statement inside the basic `LOOP` statement transfers control to the end of the current loop when `x` is greater than 3. [Example 4-10](#) is logically equivalent to [Example 4-9](#).

**See Also:**

"EXIT Statement"

In [Example 4-11](#), one basic `LOOP` statement is nested inside the other, and both have labels. The inner loop has two `EXIT WHEN` statements; one that exits the inner loop and one that exits the outer loop.

An `EXIT WHEN` statement in an inner loop can transfer control to an outer loop only if the outer loop is labeled.

In [Example 4-12](#), the outer loop is not labeled; therefore, the inner loop cannot transfer control to it.

Example 4-10 Basic LOOP Statement with EXIT WHEN Statement

```
DECLARE
  x NUMBER := 0;
BEGIN
  LOOP
    DBMS_OUTPUT.PUT_LINE('Inside loop: x = ' || TO_CHAR(x));
    x := x + 1; -- prevents infinite loop
    EXIT WHEN x > 3;
  END LOOP;
  -- After EXIT statement, control resumes here
  DBMS_OUTPUT.PUT_LINE('After loop: x = ' || TO_CHAR(x));
END;
/
```

Result:

```

Inside loop: x = 0
Inside loop: x = 1
Inside loop: x = 2
Inside loop: x = 3
After loop:  x = 4

```

Example 4-11 Nested, Labeled Basic LOOP Statements with EXIT WHEN Statements

```

DECLARE
  s PLS_INTEGER := 0;
  i PLS_INTEGER := 0;
  j PLS_INTEGER;
BEGIN
  <<outer_loop>>
  LOOP
    i := i + 1;
    j := 0;
    <<inner_loop>>
    LOOP
      j := j + 1;
      s := s + i * j; -- Sum several products
      EXIT inner_loop WHEN (j > 5);
      EXIT outer_loop WHEN ((i * j) > 15);
    END LOOP inner_loop;
  END LOOP outer_loop;
  DBMS_OUTPUT.PUT_LINE
  ('The sum of products equals: ' || TO_CHAR(s));
END;
/

```

Result:

```
The sum of products equals: 166
```

Example 4-12 Nested, Unabeled Basic LOOP Statements with EXIT WHEN Statements

```

DECLARE
  i PLS_INTEGER := 0;
  j PLS_INTEGER := 0;
BEGIN
  LOOP
    i := i + 1;
    DBMS_OUTPUT.PUT_LINE ('i = ' || i);

    LOOP
      j := j + 1;
      DBMS_OUTPUT.PUT_LINE ('j = ' || j);
      EXIT WHEN (j > 3);
    END LOOP;

    DBMS_OUTPUT.PUT_LINE ('Exited inner loop');

    EXIT WHEN (i > 2);
  END LOOP;

  DBMS_OUTPUT.PUT_LINE ('Exited outer loop');

```

```
END;
/
```

Result:

```
i = 1
j = 1
j = 2
j = 3
j = 4
Exited inner loop
i = 2
j = 5
Exited inner loop
i = 3
j = 6
Exited inner loop
Exited outer loop
```

PL/SQL procedure successfully completed.

4.2.4 CONTINUE Statement

The `CONTINUE` statement exits the current iteration of a loop unconditionally and transfers control to the next iteration of either the current loop or an enclosing labeled loop.

In [Example 4-13](#), the `CONTINUE` statement inside the basic `LOOP` statement transfers control unconditionally to the next iteration of the current loop.



See Also:

["CONTINUE Statement"](#)

Example 4-13 CONTINUE Statement in Basic LOOP Statement

```
DECLARE
  x NUMBER := 0;
BEGIN
  LOOP -- After CONTINUE statement, control resumes here
    DBMS_OUTPUT.PUT_LINE ('Inside loop: x = ' || TO_CHAR(x));
    x := x + 1;
    IF x < 3 THEN
      CONTINUE;
    END IF;
    DBMS_OUTPUT.PUT_LINE
      ('Inside loop, after CONTINUE: x = ' || TO_CHAR(x));
    EXIT WHEN x = 5;
  END LOOP;

  DBMS_OUTPUT.PUT_LINE (' After loop: x = ' || TO_CHAR(x));
END;
/
```

Result:

```

Inside loop: x = 0
Inside loop: x = 1
Inside loop: x = 2
Inside loop, after CONTINUE: x = 3
Inside loop: x = 3
Inside loop, after CONTINUE: x = 4
Inside loop: x = 4
Inside loop, after CONTINUE: x = 5
After loop: x = 5

```

4.2.5 CONTINUE WHEN Statement

The `CONTINUE WHEN` statement exits the current iteration of a loop when the condition in its `WHEN` clause is true, and transfers control to the next iteration of either the current loop or an enclosing labeled loop.

Each time control reaches the `CONTINUE WHEN` statement, the condition in its `WHEN` clause is evaluated. If the condition is not true, the `CONTINUE WHEN` statement does nothing.

In [Example 4-14](#), the `CONTINUE WHEN` statement inside the basic `LOOP` statement transfers control to the next iteration of the current loop when `x` is less than 3.

[Example 4-14](#) is logically equivalent to [Example 4-13](#).



See Also:

["CONTINUE Statement"](#)

Example 4-14 CONTINUE WHEN Statement in Basic LOOP Statement

```

DECLARE
  x NUMBER := 0;
BEGIN
  LOOP -- After CONTINUE statement, control resumes here
    DBMS_OUTPUT.PUT_LINE ('Inside loop: x = ' || TO_CHAR(x));
    x := x + 1;
    CONTINUE WHEN x < 3;
    DBMS_OUTPUT.PUT_LINE
      ('Inside loop, after CONTINUE: x = ' || TO_CHAR(x));
    EXIT WHEN x = 5;
  END LOOP;
  DBMS_OUTPUT.PUT_LINE (' After loop: x = ' || TO_CHAR(x));
END;
/

```

Result:

```

Inside loop: x = 0
Inside loop: x = 1
Inside loop: x = 2
Inside loop, after CONTINUE: x = 3
Inside loop: x = 3
Inside loop, after CONTINUE: x = 4
Inside loop: x = 4

```

```
Inside loop, after CONTINUE: x = 5
After loop: x = 5
```

4.2.6 FOR LOOP Statement

The `FOR LOOP` statement runs one or more statements while the loop index is in a specified range. The statement has this structure:

```
[ label ] FOR index IN [ REVERSE ] lower_bound..upper_bound LOOP
    statements
END LOOP [ label ];
```

Without `REVERSE`, the value of `index` starts at `lower_bound` and increases by one with each iteration of the loop until it reaches `upper_bound`. If `lower_bound` is greater than `upper_bound`, then the `statements` never run.

With `REVERSE`, the value of `index` starts at `upper_bound` and decreases by one with each iteration of the loop until it reaches `lower_bound`. If `upper_bound` is less than `lower_bound`, then the `statements` never run.

An `EXIT`, `EXIT WHEN`, `CONTINUE`, or `CONTINUE WHEN` in the `statements` can cause the loop or the current iteration of the loop to end early.

Tip:

To process the rows of a query result set, use a cursor `FOR LOOP`, which has a query instead of a range of integers. For details, see "[Processing Query Result Sets With Cursor FOR LOOP Statements](#)".

See Also:

["FOR LOOP Statement"](#)

In [Example 4-15](#), `index` is `i`, `lower_bound` is 1, and `upper_bound` is 3. The loop prints the numbers from 1 to 3.

The `FOR LOOP` statement in [Example 4-16](#) is the reverse of the one in [Example 4-15](#): It prints the numbers from 3 to 1.

In some languages, the `FOR LOOP` has a `STEP` clause that lets you specify a loop index increment other than 1. To simulate the `STEP` clause in PL/SQL, multiply each reference to the loop index by the desired increment.

In [Example 4-17](#), the `FOR LOOP` effectively increments the index by five.

Topics

- [FOR LOOP Index](#)
- [Lower Bound and Upper Bound](#)
- [EXIT WHEN or CONTINUE WHEN Statement in FOR LOOP Statement](#)

Example 4-15 FOR LOOP Statements

```
BEGIN
  DBMS_OUTPUT.PUT_LINE ('lower_bound < upper_bound');

  FOR i IN 1..3 LOOP
    DBMS_OUTPUT.PUT_LINE (i);
  END LOOP;

  DBMS_OUTPUT.PUT_LINE ('lower_bound = upper_bound');

  FOR i IN 2..2 LOOP
    DBMS_OUTPUT.PUT_LINE (i);
  END LOOP;

  DBMS_OUTPUT.PUT_LINE ('lower_bound > upper_bound');

  FOR i IN 3..1 LOOP
    DBMS_OUTPUT.PUT_LINE (i);
  END LOOP;
END;
/
```

Result:

```
lower_bound < upper_bound
1
2
3
lower_bound = upper_bound
2
lower_bound > upper_bound
```

Example 4-16 Reverse FOR LOOP Statements

```
BEGIN
  DBMS_OUTPUT.PUT_LINE ('upper_bound > lower_bound');

  FOR i IN REVERSE 1..3 LOOP
    DBMS_OUTPUT.PUT_LINE (i);
  END LOOP;

  DBMS_OUTPUT.PUT_LINE ('upper_bound = lower_bound');

  FOR i IN REVERSE 2..2 LOOP
    DBMS_OUTPUT.PUT_LINE (i);
  END LOOP;

  DBMS_OUTPUT.PUT_LINE ('upper_bound < lower_bound');

  FOR i IN REVERSE 3..1 LOOP
    DBMS_OUTPUT.PUT_LINE (i);
  END LOOP;
END;
/
```

Result:

```
upper_bound > lower_bound
3
2
```

```
1
upper_bound = lower_bound
2
upper_bound < lower_bound
```

Example 4-17 Simulating STEP Clause in FOR LOOP Statement

```
DECLARE
  step PLS_INTEGER := 5;
BEGIN
  FOR i IN 1..3 LOOP
    DBMS_OUTPUT.PUT_LINE (i*step);
  END LOOP;
END;
/
```

Result:

```
5
10
15
```

4.2.6.1 FOR LOOP Index

The index of a `FOR LOOP` statement is implicitly declared as a variable of type `PLS_INTEGER` that is local to the loop. The statements in the loop can read the value of the index, but cannot change it. Statements outside the loop cannot reference the index. After the `FOR LOOP` statement runs, the index is undefined. (A loop index is sometimes called a loop counter.)

In [Example 4-18](#), the `FOR LOOP` statement tries to change the value of its index, causing an error.

In [Example 4-19](#), a statement outside the `FOR LOOP` statement references the loop index, causing an error.

If the index of a `FOR LOOP` statement has the same name as a variable declared in an enclosing block, the local implicit declaration hides the other declaration, as [Example 4-20](#) shows.

[Example 4-21](#) shows how to change [Example 4-20](#) to allow the statement inside the loop to reference the variable declared in the enclosing block.

In [Example 4-22](#), the indexes of the nested `FOR LOOP` statements have the same name. The inner loop references the index of the outer loop by qualifying the reference with the label of the outer loop. For clarity only, the inner loop also qualifies the reference to its own index with its own label.

Example 4-18 FOR LOOP Statement Tries to Change Index Value

```
BEGIN
  FOR i IN 1..3 LOOP
    IF i < 3 THEN
      DBMS_OUTPUT.PUT_LINE (TO_CHAR(i));
    ELSE
      i := 2;
    END IF;
  END LOOP;
END;
/
```

Result:

```

        i := 2;
        *
ERROR at line 6:
ORA-06550: line 6, column 8:
PLS-00363: expression 'I' cannot be used as an assignment target
ORA-06550: line 6, column 8:
PL/SQL: Statement ignored

```

Example 4-19 Outside Statement References FOR LOOP Statement Index

```

BEGIN
  FOR i IN 1..3 LOOP
    DBMS_OUTPUT.PUT_LINE ('Inside loop, i is ' || TO_CHAR(i));
  END LOOP;

  DBMS_OUTPUT.PUT_LINE ('Outside loop, i is ' || TO_CHAR(i));
END;
/

```

Result:

```

        DBMS_OUTPUT.PUT_LINE ('Outside loop, i is ' || TO_CHAR(i));
        *
ERROR at line 6:
ORA-06550: line 6, column 58:
PLS-00201: identifier 'I' must be declared
ORA-06550: line 6, column 3:
PL/SQL: Statement ignored

```

Example 4-20 FOR LOOP Statement Index with Same Name as Variable

```

DECLARE
  i NUMBER := 5;
BEGIN
  FOR i IN 1..3 LOOP
    DBMS_OUTPUT.PUT_LINE ('Inside loop, i is ' || TO_CHAR(i));
  END LOOP;

  DBMS_OUTPUT.PUT_LINE ('Outside loop, i is ' || TO_CHAR(i));
END;
/

```

Result:

```

Inside loop, i is 1
Inside loop, i is 2
Inside loop, i is 3
Outside loop, i is 5

```

Example 4-21 FOR LOOP Statement References Variable with Same Name as Index

```

<<main>> -- Label block.
DECLARE
  i NUMBER := 5;
BEGIN
  FOR i IN 1..3 LOOP
    DBMS_OUTPUT.PUT_LINE (

```



```

        'local: ' || TO_CHAR(i) || ', global: ' ||
        TO_CHAR(main.i) -- Qualify reference with block label.
    );
END LOOP;
END main;
/

```

Result:

```

local: 1, global: 5
local: 2, global: 5
local: 3, global: 5

```

Example 4-22 Nested FOR LOOP Statements with Same Index Name

```

BEGIN
    <<outer_loop>>
    FOR i IN 1..3 LOOP
        <<inner_loop>>
        FOR i IN 1..3 LOOP
            IF outer_loop.i = 2 THEN
                DBMS_OUTPUT.PUT_LINE
                    ('outer: ' || TO_CHAR(outer_loop.i) || ' inner: '
                     || TO_CHAR(inner_loop.i));
            END IF;
        END LOOP inner_loop;
    END LOOP outer_loop;
END;
/

```

Result:

```

outer: 2 inner: 1
outer: 2 inner: 2
outer: 2 inner: 3

```

4.2.6.2 Lower Bound and Upper Bound

The lower and upper bounds of a `FOR LOOP` statement can be either numeric literals, numeric variables, or numeric expressions. If a bound does not have a numeric value, then PL/SQL raises the predefined exception `VALUE_ERROR`.

In [Example 4-24](#), the upper bound of the `FOR LOOP` statement is a variable whose value is determined at run time.

Example 4-23 FOR LOOP Statement Bounds

```

DECLARE
    first INTEGER := 1;
    last  INTEGER := 10;
    high  INTEGER := 100;
    low   INTEGER := 12;
BEGIN
    -- Bounds are numeric literals:
    FOR j IN -5..5 LOOP
        NULL;
    END LOOP;

    -- Bounds are numeric variables:

```

```

FOR k IN REVERSE first..last LOOP
    NULL;
END LOOP;

-- Lower bound is numeric literal,
-- Upper bound is numeric expression:
FOR step IN 0..(TRUNC(high/low) * 2) LOOP
    NULL;
END LOOP;
END;
/

```

Example 4-24 Specifying FOR LOOP Statement Bounds at Run Time

```

DROP TABLE temp;
CREATE TABLE temp (
    emp_no     NUMBER,
    email_addr VARCHAR2(50)
);

DECLARE
    emp_count NUMBER;
BEGIN
    SELECT COUNT(employee_id) INTO emp_count
    FROM employees;

    FOR i IN 1..emp_count LOOP
        INSERT INTO temp (emp_no, email_addr)
        VALUES(i, 'to be added later');
    END LOOP;
END;
/

```

4.2.6.3 EXIT WHEN or CONTINUE WHEN Statement in FOR LOOP Statement

Suppose that you must exit a `FOR LOOP` statement immediately if a certain condition arises. You can put the condition in an `EXIT WHEN` statement inside the `FOR LOOP` statement.

In [Example 4-25](#), the `FOR LOOP` statement executes 10 times unless the `FETCH` statement inside it fails to return a row, in which case it ends immediately.

Now suppose that the `FOR LOOP` statement that you must exit early is nested inside another `FOR LOOP` statement. If, when you exit the inner loop early, you also want to exit the outer loop, then label the outer loop and specify its name in the `EXIT WHEN` statement, as in [Example 4-26](#).

If you want to exit the inner loop early but complete the current iteration of the outer loop, then label the outer loop and specify its name in the `CONTINUE WHEN` statement, as in [Example 4-27](#).

See Also:

"[Overview of Exception Handling](#)" for information about exceptions, which can also cause a loop to end immediately if a certain condition arises

Example 4-25 EXIT WHEN Statement in FOR LOOP Statement

```
DECLARE
  v_employees employees%ROWTYPE;
  CURSOR c1 is SELECT * FROM employees;
BEGIN
  OPEN c1;
  -- Fetch entire row into v_employees record:
  FOR i IN 1..10 LOOP
    FETCH c1 INTO v_employees;
    EXIT WHEN c1%NOTFOUND;
    -- Process data here
  END LOOP;
  CLOSE c1;
END;
/
```

Example 4-26 EXIT WHEN Statement in Inner FOR LOOP Statement

```
DECLARE
  v_employees employees%ROWTYPE;
  CURSOR c1 is SELECT * FROM employees;
BEGIN
  OPEN c1;

  -- Fetch entire row into v_employees record:
  <<outer_loop>>
  FOR i IN 1..10 LOOP
    -- Process data here
    FOR j IN 1..10 LOOP
      FETCH c1 INTO v_employees;
      EXIT outer_loop WHEN c1%NOTFOUND;
      -- Process data here
    END LOOP;
  END LOOP outer_loop;

  CLOSE c1;
END;
/
```

Example 4-27 CONTINUE WHEN Statement in Inner FOR LOOP Statement

```
DECLARE
  v_employees employees%ROWTYPE;
  CURSOR c1 is SELECT * FROM employees;
BEGIN
  OPEN c1;

  -- Fetch entire row into v_employees record:
  <<outer_loop>>
  FOR i IN 1..10 LOOP
    -- Process data here
    FOR j IN 1..10 LOOP
      FETCH c1 INTO v_employees;
      CONTINUE outer_loop WHEN c1%NOTFOUND;
      -- Process data here
    END LOOP;
  END LOOP outer_loop;

  CLOSE c1;
END;
/
```

4.2.7 WHILE LOOP Statement

The `WHILE LOOP` statement runs one or more statements while a condition is true. It has this structure:

```
[ label ] WHILE condition LOOP
    statements
END LOOP [ label ];
```

If the *condition* is true, the *statements* run and control returns to the top of the loop, where *condition* is evaluated again. If the *condition* is not true, control transfers to the statement after the `WHILE LOOP` statement. To prevent an infinite loop, a statement inside the loop must make the condition false or null. For complete syntax, see "[WHILE LOOP Statement](#)".

An `EXIT`, `EXIT WHEN`, `CONTINUE`, or `CONTINUE WHEN` in the *statements* can cause the loop or the current iteration of the loop to end early.

Some languages have a `LOOP UNTIL` or `REPEAT UNTIL` structure, which tests a condition at the bottom of the loop instead of at the top, so that the statements run at least once. To simulate this structure in PL/SQL, use a basic `LOOP` statement with an `EXIT WHEN` statement:

```
LOOP
    statements
    EXIT WHEN condition;
END LOOP;
```

In [Example 4-28](#), the statements in the first `WHILE LOOP` statement never run, and the statements in the second `WHILE LOOP` statement run once.

Example 4-28 WHILE LOOP Statements

```
DECLARE
    done BOOLEAN := FALSE;
BEGIN
    WHILE done LOOP
        DBMS_OUTPUT.PUT_LINE ('This line does not print. ');
        done := TRUE; -- This assignment is not made.
    END LOOP;

    WHILE NOT done LOOP
        DBMS_OUTPUT.PUT_LINE ('Hello, world! ');
        done := TRUE;
    END LOOP;
END;
/
```

Result:

```
Hello, world!
```

4.3 Sequential Control Statements

Unlike the `IF` and `LOOP` statements, the **sequential control statements** `GOTO` and `NULL` are not crucial to PL/SQL programming.

The `GOTO` statement, which goes to a specified statement, is seldom needed. Occasionally, it simplifies logic enough to warrant its use.

The `NULL` statement, which does nothing, can improve readability by making the meaning and action of conditional statements clear.

Topics

- [GOTO Statement](#)
- [NULL Statement](#)

4.3.1 GOTO Statement

The `GOTO` statement transfers control to a label unconditionally. The label must be unique in its scope and must precede an executable statement or a PL/SQL block. When run, the `GOTO` statement transfers control to the labeled statement or block. For `GOTO` statement restrictions, see "[GOTO Statement](#)".

Use `GOTO` statements sparingly—overusing them results in code that is hard to understand and maintain. Do not use a `GOTO` statement to transfer control from a deeply nested structure to an exception handler. Instead, raise an exception. For information about the PL/SQL exception-handling mechanism, see [PL/SQL Error Handling](#).

A label can appear only before a block (as in [Example 4-21](#)) or before a statement (as in [Example 4-29](#)), not in a statement, as in [Example 4-30](#).

To correct [Example 4-30](#), add a `NULL` statement, as in [Example 4-31](#).

A `GOTO` statement can transfer control to an enclosing block from the current block, as in [Example 4-32](#).

The `GOTO` statement transfers control to the first enclosing block in which the referenced label appears.

The `GOTO` statement in [Example 4-33](#) transfers control into an `IF` statement, causing an error.

Example 4-29 GOTO Statement

```
DECLARE
  p VARCHAR2(30);
  n PLS_INTEGER := 37;
BEGIN
  FOR j in 2..ROUND(SQRT(n)) LOOP
    IF n MOD j = 0 THEN
      p := ' is not a prime number';
      GOTO print_now;
    END IF;
  END LOOP;

  p := ' is a prime number';

  <<print_now>>
  DBMS_OUTPUT.PUT_LINE(TO_CHAR(n) || p);
END;
/
```

Result:

37 is a prime number

Example 4-30 Incorrect Label Placement

```
DECLARE
  done BOOLEAN;
BEGIN
  FOR i IN 1..50 LOOP
    IF done THEN
      GOTO end_loop;
    END IF;
    <<end_loop>>
  END LOOP;
END;
/
```

Result:

```
END LOOP;
*
ERROR at line 9:
ORA-06550: line 9, column 3:
PLS-00103: Encountered the symbol "END" when expecting one of the following:
 ( begin case declare exit for goto if loop mod null raise
 return select update while with <an identifier>
 <a double-quoted delimited-identifier> <a bind variable> <<
 continue close current delete fetch lock insert open rollback
 savepoint set sql run commit forall merge pipe purge
```

Example 4-31 GOTO Statement Goes to Labeled NULL Statement

```
DECLARE
  done BOOLEAN;
BEGIN
  FOR i IN 1..50 LOOP
    IF done THEN
      GOTO end_loop;
    END IF;
    <<end_loop>>
    NULL;
  END LOOP;
END;
/
```

Example 4-32 GOTO Statement Transfers Control to Enclosing Block

```
DECLARE
  v_last_name VARCHAR2(25);
  v_emp_id NUMBER(6) := 120;
BEGIN
  <<get_name>>
  SELECT last_name INTO v_last_name
  FROM employees
  WHERE employee_id = v_emp_id;

  BEGIN
    DBMS_OUTPUT.PUT_LINE (v_last_name);
    v_emp_id := v_emp_id + 5;

    IF v_emp_id < 120 THEN
      GOTO get_name;
```

```
        END IF;  
    END;  
END;  
/
```

Result:

Weiss

Example 4-33 GOTO Statement Cannot Transfer Control into IF Statement

```
DECLARE  
    valid BOOLEAN := TRUE;  
BEGIN  
    GOTO update_row;  
  
    IF valid THEN  
        <<update_row>>  
        NULL;  
    END IF;  
END;  
/
```

Result:

```
    GOTO update_row;  
    *  
ERROR at line 4:  
ORA-06550: line 4, column 3:  
PLS-00375: illegal GOTO statement; this GOTO cannot transfer control to label  
'UPDATE_ROW'  
ORA-06550: line 6, column 12:  
PL/SQL: Statement ignored
```

4.3.2 NULL Statement

The `NULL` statement only passes control to the next statement. Some languages refer to such an instruction as a no-op (no operation).

Some uses for the `NULL` statement are:

- To provide a target for a `GOTO` statement, as in [Example 4-31](#).
- To improve readability by making the meaning and action of conditional statements clear, as in [Example 4-34](#)
- To create placeholders and stub subprograms, as in [Example 4-35](#)
- To show that you are aware of a possibility, but that no action is necessary, as in [Example 4-36](#)

In [Example 4-34](#), the `NULL` statement emphasizes that only salespersons receive commissions.

In [Example 4-35](#), the `NULL` statement lets you compile this subprogram and fill in the real body later.

 **Note:**

Using the `NULL` statement might raise an `unreachable code` warning if warnings are enabled. For information about warnings, see ["Compile-Time Warnings"](#).

In [Example 4-36](#), the `NULL` statement shows that you have chosen to take no action for grades other than A, B, C, D, and F.

Example 4-34 NULL Statement Showing No Action

```
DECLARE
  v_job_id VARCHAR2(10);
  v_emp_id NUMBER(6) := 110;
BEGIN
  SELECT job_id INTO v_job_id
  FROM employees
  WHERE employee_id = v_emp_id;

  IF v_job_id = 'SA_REP' THEN
    UPDATE employees
    SET commission_pct = commission_pct * 1.2;
  ELSE
    NULL; -- Employee is not a sales rep
  END IF;
END;
/
```

Example 4-35 NULL Statement as Placeholder During Subprogram Creation

```
CREATE OR REPLACE PROCEDURE award_bonus (
  emp_id NUMBER,
  bonus NUMBER
) AUTHID DEFINER AS
BEGIN -- Executable part starts here
  NULL; -- Placeholder
  -- (raises "unreachable code" if warnings enabled)
END award_bonus;
/
```

Example 4-36 NULL Statement in ELSE Clause of Simple CASE Statement

```
CREATE OR REPLACE PROCEDURE print_grade (
  grade CHAR
) AUTHID DEFINER AS
BEGIN
  CASE grade
    WHEN 'A' THEN DBMS_OUTPUT.PUT_LINE('Excellent');
    WHEN 'B' THEN DBMS_OUTPUT.PUT_LINE('Very Good');
    WHEN 'C' THEN DBMS_OUTPUT.PUT_LINE('Good');
    WHEN 'D' THEN DBMS_OUTPUT.PUT_LINE('Fair');
    WHEN 'F' THEN DBMS_OUTPUT.PUT_LINE('Poor');
    ELSE NULL;
  END CASE;
END;
/
BEGIN
  print_grade('A');
END;
```



```
    print_grade('S');  
END;  
/
```

Result:

Excellent

5

PL/SQL Collections and Records

PL/SQL lets you define two kinds of composite data types: collection and record.

A **composite data type** stores values that have internal components. You can pass entire composite variables to subprograms as parameters, and you can access internal components of composite variables individually. Internal components can be either scalar or composite. You can use scalar components wherever you can use scalar variables. You can use composite components wherever you can use composite variables of the same type.

Note:

If you pass a composite variable as a parameter to a remote subprogram, then you must create a redundant loop-back `DATABASE LINK`, so that when the remote subprogram compiles, the type checker that verifies the source uses the same definition of the user-defined composite variable type as the invoker uses.

In a **collection**, the internal components always have the same data type, and are called **elements**. You can access each element of a collection variable by its unique index, with this syntax: `variable_name(index)`. To create a collection variable, you either define a collection type and then create a variable of that type or use `%TYPE`.

In a **record**, the internal components can have different data types, and are called **fields**. You can access each field of a record variable by its name, with this syntax: `variable_name.field_name`. To create a record variable, you either define a `RECORD` type and then create a variable of that type or use `%ROWTYPE` or `%TYPE`.

You can create a collection of records, and a record that contains collections.

Collection Topics

- [Collection Types](#)
- [Associative Arrays](#)
- [Varrays \(Variable-Size Arrays\)](#)
- [Nested Tables](#)
- [Collection Constructors](#)
- [Qualified Expressions Overview](#)
- [Assigning Values to Collection Variables](#)
- [Multidimensional Collections](#)
- [Collection Comparisons](#)
- [Collection Methods](#)
- [Collection Types Defined in Package Specifications](#)

 **See Also:**

- *Oracle Database SQL Language Reference* for information about the `CREATE DATABASE LINK` statement
- "Querying a Collection"
- "BULK COLLECT Clause" for information about retrieving query results into a collection
- "Collection Variable Declaration" for syntax and semantics of collection type definition and collection variable declaration

Record Topics

- [Record Variables](#)
- [Assigning Values to Record Variables](#)
- [Record Comparisons](#)
- [Inserting Records into Tables](#)
- [Updating Rows with Records](#)
- [Restrictions on Record Inserts and Updates](#)

 **Note:**

The components of an explicitly listed composite data structure (such as a collection constructor or record initializer) can be evaluated in any order. If a program determines order of evaluation, then at the point where the program does so, its behavior is undefined.

5.1 Collection Types

PL/SQL has three collection types—associative array, `VARRAY` (variable-size array), and nested table.

[Table 5-1](#) summarizes their similarities and differences.

Table 5-1 PL/SQL Collection Types

Collection Type	Number of Elements	Index Type	Dense or Sparse	Uninitialized Status	Where Defined	Can Be ADT Attribute Data Type
Associative array (or index-by table)	Unspecified	String or <code>PLS_INTEGER</code>	Either	Empty	In PL/SQL block or package	No
<code>VARRAY</code> (variable-size array)	Specified	Integer	Always dense	Null	In PL/SQL block or package or at schema level	Only if defined at schema level

Table 5-1 (Cont.) PL/SQL Collection Types

Collection Type	Number of Elements	Index Type	Dense or Sparse	Uninitialized Status	Where Defined	Can Be ADT Attribute Data Type
Nested table	Unspecified	Integer	Starts dense, can become sparse	Null	In PL/SQL block or package or at schema level	Only if defined at schema level

Number of Elements

If the number of elements is specified, it is the maximum number of elements in the collection. If the number of elements is unspecified, the maximum number of elements in the collection is the upper limit of the index type.

Dense or Sparse

A **dense collection** has no gaps between elements—every element between the first and last element is defined and has a value (the value can be `NULL` unless the element has a `NOT NULL` constraint). A **sparse collection** has gaps between elements.

Uninitialized Status

An **empty collection** exists but has no elements. To add elements to an empty collection, invoke the `EXTEND` method (described in "[EXTEND Collection Method](#)").

A **null collection** (also called an **atomically null collection**) does not exist. To change a null collection to an existing collection, you must initialize it, either by making it empty or by assigning a non-`NULL` value to it (for details, see "[Collection Constructors](#)" and "[Assigning Values to Collection Variables](#)"). You cannot use the `EXTEND` method to initialize a null collection.

Where Defined

A collection type defined in a PL/SQL block is a **local type**. It is available only in the block, and is stored in the database only if the block is in a standalone or package subprogram. (Standalone and package subprograms are explained in "[Nested, Package, and Standalone Subprograms](#)".)

A collection type defined in a package specification is a **public item**. You can reference it from outside the package by qualifying it with the package name (`package_name.type_name`). It is stored in the database until you drop the package. (Packages are explained in "[PL/SQL Packages](#)".)

A collection type defined at schema level is a **standalone type**. You create it with the "[CREATE TYPE Statement](#)". It is stored in the database until you drop it with the "[DROP TYPE Statement](#)".

Note:

A collection type defined in a package specification is incompatible with an identically defined local or standalone collection type (see [Example 5-33](#) and [Example 5-34](#)).

Can Be ADT Attribute Data Type

To be an ADT attribute data type, a collection type must be a standalone collection type. For other restrictions, see [Restrictions on datatype](#).

Translating Non-PL/SQL Composite Types to PL/SQL Composite Types

If you have code or business logic that uses another language, you can usually translate the array and set types of that language directly to PL/SQL collection types. For example:

Non-PL/SQL Composite Type	Equivalent PL/SQL Composite Type
Hash table	Associative array
Unordered table	Associative array
Set	Nested table
Bag	Nested table
Array	VARRAY

See Also:

Oracle Database SQL Language Reference for information about the `CAST` function, which converts one SQL data type or collection-typed value into another SQL data type or collection-typed value.

5.2 Associative Arrays

An **associative array** (formerly called **PL/SQL table** or **index-by table**) is a set of key-value pairs. Each key is a unique index, used to locate the associated value with the syntax `variable_name(index)`.

The data type of `index` can be either a string type (`VARCHAR2`, `VARCHAR`, `STRING`, or `LONG`) or `PLS_INTEGER`. Indexes are stored in sort order, not creation order. For string types, sort order is determined by the initialization parameters `NLS_SORT` and `NLS_COMP`.

Like a database table, an associative array:

- Is empty (but not null) until you populate it
- Can hold an unspecified number of elements, which you can access without knowing their positions

Unlike a database table, an associative array:

- Does not need disk space or network operations
- Cannot be manipulated with DML statements

Topics

- [Declaring Associative Array Constants](#)
- [NLS Parameter Values Affect Associative Arrays Indexed by String](#)

- [Appropriate Uses for Associative Arrays](#)

See Also:

- [Table 5-1](#) for a summary of associative array characteristics
- `"assoc_array_type_def ::="` for the syntax of an associative array type definition

Example 5-1 Associative Array Indexed by String

This example defines a type of associative array indexed by string, declares a variable of that type, populates the variable with three elements, changes the value of one element, and prints the values (in sort order, not creation order). (`FIRST` and `NEXT` are collection methods, described in ["Collection Methods"](#).)

Live SQL:

You can view and run this example on Oracle Live SQL at [Associative Array Indexed by String](#)

```

DECLARE
  -- Associative array indexed by string:

  TYPE population IS TABLE OF NUMBER -- Associative array type
    INDEX BY VARCHAR2(64);           -- indexed by string

  city_population population;         -- Associative array variable
  i VARCHAR2(64);                     -- Scalar variable

BEGIN
  -- Add elements (key-value pairs) to associative array:

  city_population('Smallville') := 2000;
  city_population('Midland')     := 750000;
  city_population('Megalopolis') := 1000000;

  -- Change value associated with key 'Smallville':

  city_population('Smallville') := 2001;

  -- Print associative array:

  i := city_population.FIRST; -- Get first element of array

  WHILE i IS NOT NULL LOOP
    DBMS_Output.PUT_LINE
      ('Population of ' || i || ' is ' || city_population(i));
    i := city_population.NEXT(i); -- Get next element of array
  END LOOP;
END;
/

```

Result:

```
Population of Megalopolis is 1000000
Population of Midland is 750000
Population of Smallville is 2001
```

Example 5-2 Function Returns Associative Array Indexed by PLS_INTEGER

This example defines a type of associative array indexed by `PLS_INTEGER` and a function that returns an associative array of that type.

Live SQL:

You can view and run this example on Oracle Live SQL at [Function Returns Associative Array Indexed by PLS_INTEGER](#)

```
DECLARE
  TYPE sum_multiples IS TABLE OF PLS_INTEGER INDEX BY PLS_INTEGER;
  n PLS_INTEGER := 5; -- number of multiples to sum for display
  sn PLS_INTEGER := 10; -- number of multiples to sum
  m PLS_INTEGER := 3; -- multiple

  FUNCTION get_sum_multiples (
    multiple IN PLS_INTEGER,
    num      IN PLS_INTEGER
  ) RETURN sum_multiples
  IS
    s sum_multiples;
  BEGIN
    FOR i IN 1..num LOOP
      s(i) := multiple * ((i * (i + 1)) / 2); -- sum of multiples
    END LOOP;
    RETURN s;
  END get_sum_multiples;

BEGIN
  DBMS_OUTPUT.PUT_LINE (
    'Sum of the first ' || TO_CHAR(n) || ' multiples of ' ||
    TO_CHAR(m) || ' is ' || TO_CHAR(get_sum_multiples (m, sn)(n))
  );
END;
/
```

Result:

```
Sum of the first 5 multiples of 3 is 45
```

5.2.1 Declaring Associative Array Constants

When declaring an associative array constant, you must create a function that populates the associative array with its initial value and then invoke the function in the constant declaration.

For information about constructors, see "[Collection Constructors](#)".

Example 5-3 Declaring Associative Array Constant

In this example, the function does for the associative array what a constructor does for a varray or nested table.

 **Live SQL:**

You can view and run this example on Oracle Live SQL at [Declaring Associative Array Constant](#)

```
CREATE OR REPLACE PACKAGE My_Types AUTHID CURRENT_USER IS
  TYPE My_AA IS TABLE OF VARCHAR2(20) INDEX BY PLS_INTEGER;
  FUNCTION Init_My_AA RETURN My_AA;
END My_Types;
/
CREATE OR REPLACE PACKAGE BODY My_Types IS
  FUNCTION Init_My_AA RETURN My_AA IS
    Ret My_AA;
  BEGIN
    Ret(-10) := '-ten';
    Ret(0) := 'zero';
    Ret(1) := 'one';
    Ret(2) := 'two';
    Ret(3) := 'three';
    Ret(4) := 'four';
    Ret(9) := 'nine';
    RETURN Ret;
  END Init_My_AA;
END My_Types;
/
DECLARE
  v CONSTANT My_Types.My_AA := My_Types.Init_My_AA();
BEGIN
  DECLARE
    Idx PLS_INTEGER := v.FIRST();
  BEGIN
    WHILE Idx IS NOT NULL LOOP
      DBMS_OUTPUT.PUT_LINE(TO_CHAR(Idx, '999')||LPAD(v(Idx), 7));
      Idx := v.NEXT(Idx);
    END LOOP;
  END;
END;
/
```

Result:

```
-10  -ten
0    zero
1    one
2    two
3    three
4    four
9    nine
```

PL/SQL procedure successfully completed.

5.2.2 NLS Parameter Values Affect Associative Arrays Indexed by String

National Language Support (NLS) parameters such as `NLS_SORT`, `NLS_COMP`, and `NLS_DATE_FORMAT` affect associative arrays indexed by string.

Topics

- [Changing NLS Parameter Values After Populating Associative Arrays](#)
- [Indexes of Data Types Other Than VARCHAR2](#)
- [Passing Associative Arrays to Remote Databases](#)



See Also:

Oracle Database Globalization Support Guide for information about linguistic sort parameters

5.2.2.1 Changing NLS Parameter Values After Populating Associative Arrays

The initialization parameters `NLS_SORT` and `NLS_COMP` determine the storage order of string indexes of an associative array.

If you change the value of either parameter after populating an associative array indexed by string, then the collection methods `FIRST`, `LAST`, `NEXT`, and `PRIOR` might return unexpected values or raise exceptions. If you must change these parameter values during your session, restore their original values before operating on associative arrays indexed by string.



See Also:

[Collection Methods](#) for more information about `FIRST`, `LAST`, `NEXT`, and `PRIOR`

5.2.2.2 Indexes of Data Types Other Than VARCHAR2

In the declaration of an associative array indexed by string, the string type must be `VARCHAR2` or one of its subtypes.

However, you can populate the associative array with indexes of any data type that the `TO_CHAR` function can convert to `VARCHAR2`.

If your indexes have data types other than `VARCHAR2` and its subtypes, ensure that these indexes remain consistent and unique if the values of initialization parameters change. For example:

- Do not use `TO_CHAR(SYSDATE)` as an index.

If the value of `NLS_DATE_FORMAT` changes, then the value of `(TO_CHAR(SYSDATE))` might also change.

- Do not use different `NVARCHAR2` indexes that might be converted to the same `VARCHAR2` value.
- Do not use `CHAR` or `VARCHAR2` indexes that differ only in case, accented characters, or punctuation characters.

If the value of `NLS_SORT` ends in `_CI` (case-insensitive comparisons) or `_AI` (accent- and case-insensitive comparisons), then indexes that differ only in case, accented characters, or punctuation characters might be converted to the same value.

 **See Also:**

Oracle Database SQL Language Reference for more information about `TO_CHAR`

5.2.2.3 Passing Associative Arrays to Remote Databases

If you pass an associative array as a parameter to a remote database, and the local and the remote databases have different `NLS_SORT` or `NLS_COMP` values, then:

- The collection method `FIRST`, `LAST`, `NEXT` or `PRIOR` (described in "Collection Methods") might return unexpected values or raise exceptions.
- Indexes that are unique on the local database might not be unique on the remote database, raising the predefined exception `VALUE_ERROR`.

5.2.3 Appropriate Uses for Associative Arrays

An associative array is appropriate for:

- A relatively small lookup table, which can be constructed in memory each time you invoke the subprogram or initialize the package that declares it
- Passing collections to and from the database server

Declare formal subprogram parameters of associative array types. With Oracle Call Interface (OCI) or an Oracle precompiler, bind the host arrays to the corresponding actual parameters. PL/SQL automatically converts between host arrays and associative arrays indexed by `PLS_INTEGER`.

 **Note:**

You cannot bind an associative array indexed by `VARCHAR`.

 **Note:**

You cannot declare an associative array type at schema level. Therefore, to pass an associative array variable as a parameter to a standalone subprogram, you must declare the type of that variable in a package specification. Doing so makes the type available to both the invoked subprogram (which declares a formal parameter of that type) and the invoking subprogram or anonymous block (which declares and passes the variable of that type). See [Example 10-2](#).

 **Tip:**

The most efficient way to pass collections to and from the database server is to use associative arrays with the `FORALL` statement or `BULK COLLECT` clause. For details, see "[FORALL Statement](#)" and "[BULK COLLECT Clause](#)".

An associative array is intended for temporary data storage. To make an associative array persistent for the life of a database session, declare it in a package specification and populate it in the package body.

5.3 Varrays (Variable-Size Arrays)

A **varray (variable-size array)** is an array whose number of elements can vary from zero (empty) to the declared maximum size.

To access an element of a varray variable, use the syntax `variable_name(index)`. The lower bound of `index` is 1; the upper bound is the current number of elements. The upper bound changes as you add or delete elements, but it cannot exceed the maximum size. When you store and retrieve a varray from the database, its indexes and element order remain stable.

[Figure 5-1](#) shows a varray variable named `Grades`, which has maximum size 10 and contains seven elements. `Grades(n)` references the n th element of `Grades`. The upper bound of `Grades` is 7, and it cannot exceed 10.

Figure 5-1 Varray of Maximum Size 10 with 7 Elements

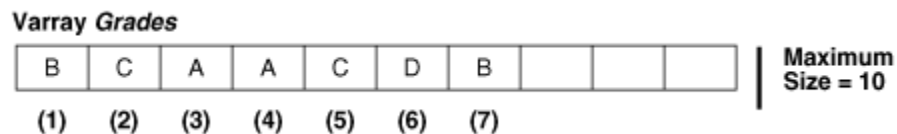

The database stores a varray variable as a single object. If a varray variable is less than 4 KB, it resides inside the table of which it is a column; otherwise, it resides outside the table but in the same tablespace.

An uninitialized varray variable is a null collection. You must initialize it, either by making it empty or by assigning a non-NULL value to it. For details, see "[Collection Constructors](#)" and "[Assigning Values to Collection Variables](#)".

Topics

- [Appropriate Uses for Varrays](#)

See Also:

- [Table 5-1](#) for a summary of varray characteristics
- "[varray_type_def ::=](#)" for the syntax of a VARRAY type definition
- "[CREATE TYPE Statement](#)" for information about creating standalone VARRAY types
- *Oracle Database SQL Language Reference* for more information about varrays

Example 5-4 Varray (Variable-Size Array)

This example defines a local VARRAY type, declares a variable of that type (initializing it with a constructor), and defines a procedure that prints the varray. The example invokes the procedure three times: After initializing the variable, after changing the values of two elements individually, and after using a constructor to change the values of all elements. (For an example of a procedure that prints a varray that might be null or empty, see [Example 5-26](#).)

Live SQL:

You can view and run this example on Oracle Live SQL at [Varray \(Variable-Size Array\)](#)

```
DECLARE
  TYPE Foursome IS VARRAY(4) OF VARCHAR2(15); -- VARRAY type

  -- varray variable initialized with constructor:

  team Foursome := Foursome('John', 'Mary', 'Alberto', 'Juanita');

  PROCEDURE print_team (heading VARCHAR2) IS
  BEGIN
    DBMS_OUTPUT.PUT_LINE(heading);

    FOR i IN 1..4 LOOP
      DBMS_OUTPUT.PUT_LINE(i || '.' || team(i));
    END LOOP;

    DBMS_OUTPUT.PUT_LINE('---');
  END;

BEGIN
  print_team('2001 Team:');
```

```
team(3) := 'Pierre'; -- Change values of two elements
team(4) := 'Yvonne';
print_team('2005 Team:');

-- Invoke constructor to assign new values to varray variable:

team := Foursome('Arun', 'Amitha', 'Allan', 'Mae');
print_team('2009 Team:');
END;
/
```

Result:

```
2001 Team:
1.John
2.Mary
3.Alberto
4.Juanita
---
2005 Team:
1.John
2.Mary
3.Pierre
4.Yvonne
---
2009 Team:
1.Arun
2.Amitha
3.Allan
4.Mae
---
```

5.3.1 Appropriate Uses for Varrays

A varray is appropriate when:

- You know the maximum number of elements.
- You usually access the elements sequentially.

Because you must store or retrieve all elements at the same time, a varray might be impractical for large numbers of elements.

5.4 Nested Tables

In the database, a **nested table** is a column type that stores an unspecified number of rows in no particular order.

When you retrieve a nested table value from the database into a PL/SQL nested table variable, PL/SQL gives the rows consecutive indexes, starting at 1. Using these indexes, you can access the individual rows of the nested table variable. The syntax is *variable_name(index)*. The indexes and row order of a nested table might not remain stable as you store and retrieve the nested table from the database.

The amount of memory that a nested table variable occupies can increase or decrease dynamically, as you add or delete elements.

An uninitialized nested table variable is a null collection. You must initialize it, either by making it empty or by assigning a non-NULL value to it. For details, see "[Collection Constructors](#)" and "[Assigning Values to Collection Variables](#)".

**Note:**

[Example 5-19](#), [Example 5-21](#), and [Example 5-22](#) reuse `nt_type` and `print_nt`.

Topics

- [Important Differences Between Nested Tables and Arrays](#)
- [Appropriate Uses for Nested Tables](#)

**See Also:**

- [Table 5-1](#) for a summary of nested table characteristics
- "[nested_table_type_def ::=](#)" for the syntax of a nested table type definition
- "[CREATE TYPE Statement](#)" for information about creating standalone nested table types
- "[INSTEAD OF DML Triggers](#)" for information about triggers that update nested table columns of views
- *Oracle Database SQL Language Reference* for more information about nested tables

Example 5-5 Nested Table of Local Type

This example defines a local nested table type, declares a variable of that type (initializing it with a constructor), and defines a procedure that prints the nested table. (The procedure uses the collection methods `FIRST` and `LAST`, described in "[Collection Methods](#)".) The example invokes the procedure three times: After initializing the variable, after changing the value of one element, and after using a constructor to change the values of all elements. After the second constructor invocation, the nested table has only two elements. Referencing element 3 would raise error ORA-06533.

**Live SQL:**

You can view and run this example on Oracle Live SQL at [Nested Table of Local Type](#)

```
DECLARE
  TYPE Roster IS TABLE OF VARCHAR2(15); -- nested table type

  -- nested table variable initialized with constructor:
  names Roster := Roster('D Caruso', 'J Hamil', 'D Piro', 'R Singh');
```

```

PROCEDURE print_names (heading VARCHAR2) IS
BEGIN
    DBMS_OUTPUT.PUT_LINE(heading);

    FOR i IN names.FIRST .. names.LAST LOOP -- For first to last element
        DBMS_OUTPUT.PUT_LINE(names(i));
    END LOOP;

    DBMS_OUTPUT.PUT_LINE('---');
END;

BEGIN
    print_names('Initial Values:');

    names(3) := 'P Perez'; -- Change value of one element
    print_names('Current Values:');

    names := Roster('A Jansen', 'B Gupta'); -- Change entire table
    print_names('Current Values:');
END;
/

```

Result:

```

Initial Values:
D Caruso
J Hamil
D Piro
R Singh
---
Current Values:
D Caruso
J Hamil
P Perez
R Singh
---
Current Values:
A Jansen
B Gupta

```

Example 5-6 Nested Table of Standalone Type

This example defines a standalone nested table type, `nt_type`, and a standalone procedure to print a variable of that type, `print_nt`. An anonymous block declares a variable of type `nt_type`, initializing it to empty with a constructor, and invokes `print_nt` twice: After initializing the variable and after using a constructor to change the values of all elements.

**Live SQL:**

You can view and run this example on Oracle Live SQL at [Nested Table of Standalone Type](#)

```

CREATE OR REPLACE TYPE nt_type IS TABLE OF NUMBER;
/
CREATE OR REPLACE PROCEDURE print_nt (nt nt_type) AUTHID DEFINER IS

```

```
    i NUMBER;
BEGIN
    i := nt.FIRST;

    IF i IS NULL THEN
        DBMS_OUTPUT.PUT_LINE('nt is empty');
    ELSE
        WHILE i IS NOT NULL LOOP
            DBMS_OUTPUT.PUT('nt.( ' || i || ' ) = ');
            DBMS_OUTPUT.PUT_LINE(NVL(TO_CHAR(nt(i)), 'NULL'));
            i := nt.NEXT(i);
        END LOOP;
    END IF;

    DBMS_OUTPUT.PUT_LINE('---');
END print_nt;
/
DECLARE
    nt nt_type := nt_type(); -- nested table variable initialized to empty
BEGIN
    print_nt(nt);
    nt := nt_type(90, 9, 29, 58);
    print_nt(nt);
END;
/
```

Result:

```
nt is empty
---
nt.(1) = 90
nt.(2) = 9
nt.(3) = 29
nt.(4) = 58
---
```

5.4.1 Important Differences Between Nested Tables and Arrays

Conceptually, a nested table is like a one-dimensional array with an arbitrary number of elements. However, a nested table differs from an array in these important ways:

- An array has a declared number of elements, but a nested table does not. The size of a nested table can increase dynamically.
- An array is always dense. A nested array is dense initially, but it can become sparse, because you can delete elements from it.

[Figure 5-2](#) shows the important differences between a nested table and an array.

Figure 5-2 Array and Nested Table

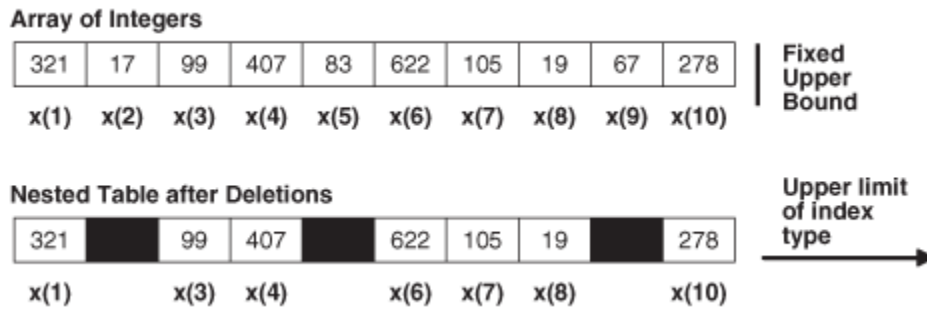

5.4.2 Appropriate Uses for Nested Tables

A nested table is appropriate when:

- The number of elements is not set.
- Index values are not consecutive.
- You must delete or update some elements, but not all elements simultaneously.

Nested table data is stored in a separate store table, a system-generated database table. When you access a nested table, the database joins the nested table with its store table. This makes nested tables suitable for queries and updates that affect only some elements of the collection.

- You would create a separate lookup table, with multiple entries for each row of the main table, and access it through join queries.

5.5 Collection Constructors

A **collection constructor (constructor)** is a system-defined function with the same name as a collection type, which returns a collection of that type.

Note:

This topic applies only to varrays and nested tables. In this topic, *collection* means *varray or nested table*. Associative arrays use qualified expressions and aggregates (see [Qualified Expressions Overview](#)).

The syntax of a constructor invocation is:

```
collection_type ( [ value [, value ]... ] )
```

If the parameter list is empty, the constructor returns an empty collection. Otherwise, the constructor returns a collection that contains the specified values. For semantic details, see "[collection_constructor](#)".

You can assign the returned collection to a collection variable (of the same type) in the variable declaration and in the executable part of a block.

Example 5-7 Initializing Collection (Varray) Variable to Empty

This example invokes a constructor twice: to initialize the varray variable `team` to empty in its declaration, and to give it new values in the executable part of the block. The procedure `print_team` shows the initial and final values of `team`. To determine when `team` is empty, `print_team` uses the collection method `COUNT`, described in "Collection Methods". (For an example of a procedure that prints a varray that might be null, see [Example 5-26](#).)

Live SQL:

You can view and run this example on Oracle Live SQL at [Initializing Collection \(Varray\) Variable to Empty](#)

```
DECLARE
  TYPE Foursome IS VARRAY(4) OF VARCHAR2(15);
  team Foursome := Foursome(); -- initialize to empty

PROCEDURE print_team (heading VARCHAR2)
IS
BEGIN
  DBMS_OUTPUT.PUT_LINE(heading);

  IF team.COUNT = 0 THEN
    DBMS_OUTPUT.PUT_LINE('Empty');
  ELSE
    FOR i IN 1..4 LOOP
      DBMS_OUTPUT.PUT_LINE(i || '.' || team(i));
    END LOOP;
  END IF;

  DBMS_OUTPUT.PUT_LINE('---');
END;

BEGIN
  print_team('Team:');
  team := Foursome('John', 'Mary', 'Alberto', 'Juanita');
  print_team('Team:');
END;
/
```

Result:

```
Team:
Empty
---
Team:
1.John
2.Mary
3.Alberto
4.Juanita
---
```

5.6 Qualified Expressions Overview

Qualified expressions improve program clarity and developer productivity by providing the ability to declare and define a complex value in a compact form where the value is needed.

A qualified expression combines expression elements to create values of a `RECORD` type or associative array type.

Qualified expressions use an explicit type indication to provide the type of the qualified item. This explicit indication is known as a `typemark`.

The syntax for qualified expressions is:

```
qualified_expression ::= typemark ( aggregate )
aggregate ::= [ positional_choice_list ] [explicit_choice_list]
positional_choice_list ::= (expr )+
explicit_choice_list ::= named_choice_list | indexed_choice_list
named_choice_list ::= identifier => expr [,]+
indexed_choice_list ::= expr => expr [,] +
```

See [qualified_expression ::=](#) for more information about the syntax and semantics.

Example 5-8 Assigning Values to RECORD Type Variables Using Qualified Expressions

This example shows the declaration, initialization, and definition of `RECORD` type variables. Type `rec_t` is defined and partially initialized in package `pkg`. Variable `v_rec1` is declared with that type and assigned initial values using the positional notation. Variable `v_rec2` is declared with that type as well and assigned initial values using the named association syntax. Variable `v_rec3` is assigned the `NULL` values. The procedure `print_rec` displays the values of the local variable `v_rec1`, followed by the procedure parameter `pi_rec` variable values. If no parameter is passed to the procedure, it displays the initial values set in the procedure definition.

Live SQL:

You can view and run this example on Oracle Live SQL at [18c Assigning Values to RECORD Type Variables Using Qualified Expressions](#)

```
CREATE PACKAGE pkg IS
  TYPE rec_t IS RECORD
    (year PLS_INTEGER := 2,
     name VARCHAR2 (100) );
END;

DECLARE
  v_rec1 pkg.rec_t := pkg.rec_t(1847,'ONE EIGHT FOUR SEVEN');
  v_rec2 pkg.rec_t := pkg.rec_t(year => 1, name => 'ONE');
  v_rec3 pkg.rec_t := pkg.rec_t(NULL,NULL);

PROCEDURE print_rec ( pi_rec pkg.rec_t := pkg.rec_t(1847+1,
'a' || 'b')) IS
  v_rec1 pkg.rec_t := pkg.rec_t(2847,'TWO EIGHT FOUR SEVEN');
BEGIN
```

```

    DBMS_OUTPUT.PUT_LINE (NVL(v_rec1.year,0) ||' ' ||NVL(v_rec1.name,'N/A'));
    DBMS_OUTPUT.PUT_LINE (NVL(pi_rec.year,0) ||' ' ||NVL(pi_rec.name,'N/A'));
END;
BEGIN
    print_rec(v_rec1);
    print_rec(v_rec2);
    print_rec(v_rec3);
    print_rec();
END;

```

```

2847 TWO EIGHT FOUR SEVEN
1847 ONE EIGHT FOUR SEVEN
2847 TWO EIGHT FOUR SEVEN
1 ONE
2847 TWO EIGHT FOUR SEVEN
0 N/A
2847 TWO EIGHT FOUR SEVEN
1848 ab

```

Example 5-9 Assigning Values to Associative Array Type Variables Using Qualified Expressions

This example uses a function to display the values of a table of `BOOLEAN`.

Live SQL:

You can view and run this example on Oracle Live SQL at [18c Assigning Values to RECORD Type Variables Using Qualified Expressions](#)

```

CREATE FUNCTION print_bool (v IN BOOLEAN)
    RETURN VARCHAR2
IS
    v_rtn VARCHAR2(10);
BEGIN
    CASE v
    WHEN TRUE THEN
        v_rtn := 'TRUE';
    WHEN FALSE THEN
        v_rtn := 'FALSE';
    ELSE
        v_rtn := 'NULL';
    END CASE;
    RETURN v_rtn;
END print_bool;

```

The variable `v_aa1` is initialized using index key-value pairs.

```

DECLARE
    TYPE t_aa IS TABLE OF BOOLEAN INDEX BY PLS_INTEGER;
    v_aa1 t_aa := t_aa(1=>FALSE,

```

```
                2=>TRUE,  
                3=>NULL);  
  
BEGIN  
  DBMS_OUTPUT.PUT_LINE(print_bool(v_aa1(1)));  
  DBMS_OUTPUT.PUT_LINE(print_bool(v_aa1(2)));  
  DBMS_OUTPUT.PUT_LINE(print_bool(v_aa1(3)));  
END;  
  
FALSE  
TRUE  
NULL
```

5.7 Assigning Values to Collection Variables

You can assign a value to a collection variable in these ways:

- Invoke a constructor to create a collection and assign it to the collection variable.
- Use the assignment statement to assign it the value of another existing collection variable.
- Pass it to a subprogram as an `OUT` or `IN OUT` parameter, and then assign the value inside the subprogram.
- Use a qualified expression to assign values to an associative array (see [Example 5-9](#)).

To assign a value to a scalar element of a collection variable, reference the element as `collection_variable_name(index)` and assign it a value.

Topics

- [Data Type Compatibility](#)
- [Assigning Null Values to Varray or Nested Table Variables](#)
- [Assigning Set Operation Results to Nested Table Variables](#)

See Also:

- ["Collection Constructors"](#)
- ["Assignment Statement"](#) syntax diagram
- ["Assigning Values to Variables"](#) for instructions on how to assign a value to a scalar element of a collection variable
- ["BULK COLLECT Clause"](#)

5.7.1 Data Type Compatibility

You can assign a collection to a collection variable only if they have the same data type. Having the same element type is not enough.

Example 5-10 Data Type Compatibility for Collection Assignment

In this example, `VARRAY` types `triplet` and `trio` have the same element type, `VARCHAR(15)`. Collection variables `group1` and `group2` have the same data type, `triplet`, but collection variable `group3` has the data type `trio`. The assignment of `group1` to `group2` succeeds, but the assignment of `group1` to `group3` fails.

 **Live SQL:**

You can view and run this example on Oracle Live SQL at [Data Type Compatibility for Collection Assignment](#)

```
DECLARE
  TYPE triplet IS VARRAY(3) OF VARCHAR2(15);
  TYPE trio    IS VARRAY(3) OF VARCHAR2(15);

  group1 triplet := triplet('Jones', 'Wong', 'Marceau');
  group2 triplet;
  group3 trio;
BEGIN
  group2 := group1; -- succeeds
  group3 := group1; -- fails
END;
/
```

Result:

```
ORA-06550: line 10, column 13:
PLS-00382: expression is of wrong type
```

5.7.2 Assigning Null Values to Varray or Nested Table Variables

To a varray or nested table variable, you can assign the value `NULL` or a null collection of the same data type. Either assignment makes the variable null.

[Example 5-11](#) initializes the nested table variable `dept_names` to a non-null value; assigns a null collection to it, making it null; and re-initializes it to a different non-null value.

Example 5-11 Assigning Null Value to Nested Table Variable **Live SQL:**

You can view and run this example on Oracle Live SQL at [Assigning Null Value to Nested Table Variable](#)

```
DECLARE
  TYPE dnames_tab IS TABLE OF VARCHAR2(30);

  dept_names dnames_tab := dnames_tab(
    'Shipping','Sales','Finance','Payroll'); -- Initialized to non-null value

  empty_set dnames_tab; -- Not initialized, therefore null
```

```

PROCEDURE print_dept_names_status IS
BEGIN
  IF dept_names IS NULL THEN
    DBMS_OUTPUT.PUT_LINE('dept_names is null.');
```

```

ELSE
  DBMS_OUTPUT.PUT_LINE('dept_names is not null.');
```

```

END IF;
END print_dept_names_status;

BEGIN
  print_dept_names_status;
  dept_names := empty_set; -- Assign null collection to dept_names.
  print_dept_names_status;
  dept_names := dnames_tab (
    'Shipping','Sales','Finance','Payroll'); -- Re-initialize dept_names
  print_dept_names_status;
END;
/
```

Result:

```

dept_names is not null.
dept_names is null.
dept_names is not null.
```

5.7.3 Assigning Set Operation Results to Nested Table Variables

To a nested table variable, you can assign the result of a SQL `MULTISET` operation or SQL `SET` function invocation.

The SQL `MULTISET` operators combine two nested tables into a single nested table. The elements of the two nested tables must have comparable data types. For information about the `MULTISET` operators, see *Oracle Database SQL Language Reference*.

The SQL `SET` function takes a nested table argument and returns a nested table of the same data type whose elements are distinct (the function eliminates duplicate elements). For information about the `SET` function, see *Oracle Database SQL Language Reference*.

Example 5-12 Assigning Set Operation Results to Nested Table Variable

This example assigns the results of several `MULTISET` operations and one `SET` function invocation of the nested table variable `answer`, using the procedure `print_nested_table` to print `answer` after each assignment. The procedure uses the collection methods `FIRST` and `LAST`, described in "[Collection Methods](#)".

Live SQL:

You can view and run this example on Oracle Live SQL at [Assigning Set Operation Results to Nested Table Variable](#)

```

DECLARE
  TYPE nested_typ IS TABLE OF NUMBER;

  nt1    nested_typ := nested_typ(1,2,3);
```

```

nt2    nested_typ := nested_typ(3,2,1);
nt3    nested_typ := nested_typ(2,3,1,3);
nt4    nested_typ := nested_typ(1,2,4);
answer nested_typ;

PROCEDURE print_nested_table (nt nested_typ) IS
  output VARCHAR2(128);
BEGIN
  IF nt IS NULL THEN
    DBMS_OUTPUT.PUT_LINE('Result: null set');
  ELSIF nt.COUNT = 0 THEN
    DBMS_OUTPUT.PUT_LINE('Result: empty set');
  ELSE
    FOR i IN nt.FIRST .. nt.LAST LOOP -- For first to last element
      output := output || nt(i) || ' ';
    END LOOP;
    DBMS_OUTPUT.PUT_LINE('Result: ' || output);
  END IF;
END print_nested_table;

BEGIN
  answer := nt1 MULTISSET UNION nt4;
  print_nested_table(answer);
  answer := nt1 MULTISSET UNION nt3;
  print_nested_table(answer);
  answer := nt1 MULTISSET UNION DISTINCT nt3;
  print_nested_table(answer);
  answer := nt2 MULTISSET INTERSECT nt3;
  print_nested_table(answer);
  answer := nt2 MULTISSET INTERSECT DISTINCT nt3;
  print_nested_table(answer);
  answer := SET(nt3);
  print_nested_table(answer);
  answer := nt3 MULTISSET EXCEPT nt2;
  print_nested_table(answer);
  answer := nt3 MULTISSET EXCEPT DISTINCT nt2;
  print_nested_table(answer);
END;
/

```

Result:

```

Result: 1 2 3 1 2 4
Result: 1 2 3 2 3 1 3
Result: 1 2 3
Result: 3 2 1
Result: 3 2 1
Result: 2 3 1
Result: 3
Result: empty set

```

5.8 Multidimensional Collections

Although a collection has only one dimension, you can model a multidimensional collection with a collection whose elements are collections.

Example 5-13 Two-Dimensional Varray (Varray of Varrays)

In this example, `nva` is a two-dimensional varray—a varray of varrays of integers.

 **Live SQL:**

You can view and run this example on Oracle Live SQL at [Two-Dimensional Varray \(Varray of Varrays\)](#)

```

DECLARE
  TYPE t1 IS VARRAY(10) OF INTEGER; -- varray of integer
  va t1 := t1(2,3,5);

  TYPE nt1 IS VARRAY(10) OF t1;      -- varray of varray of integer
  nva nt1 := nt1(va, t1(55,6,73), t1(2,4), va);

  i INTEGER;
  val t1;
BEGIN
  i := nva(2)(3);
  DBMS_OUTPUT.PUT_LINE('i = ' || i);

  nva.EXTEND;
  nva(5) := t1(56, 32);           -- replace inner varray elements
  nva(4) := t1(45,43,67,43345);  -- replace an inner integer element
  nva(4)(4) := 1;                -- replace 43345 with 1

  nva(4).EXTEND; -- add element to 4th varray element
  nva(4)(5) := 89; -- store integer 89 there
END;
/

```

Result:

i = 73

Example 5-14 Nested Tables of Nested Tables and Varrays of Integers

In this example, `ntb1` is a nested table of nested tables of strings, and `ntb2` is a nested table of varrays of integers.

 **Live SQL:**

You can view and run this example on Oracle Live SQL at [Nested Tables of Nested Tables and Varrays of Integers](#)

```

DECLARE
  TYPE tb1 IS TABLE OF VARCHAR2(20); -- nested table of strings
  vtb1 tb1 := tb1('one', 'three');

  TYPE ntb1 IS TABLE OF tb1; -- nested table of nested tables of strings
  vntb1 ntb1 := ntb1(vtb1);

  TYPE tv1 IS VARRAY(10) OF INTEGER; -- varray of integers
  TYPE ntb2 IS TABLE OF tv1;      -- nested table of varrays of integers
  vntb2 ntb2 := ntb2(tv1(3,5), tv1(5,7,3));

BEGIN

```

```

vntbl.EXTEND;
vntbl(2) := vntbl(1);
vntbl.DELETE(1);      -- delete first element of vntbl
vntbl(2).DELETE(1);  -- delete first string from second table in nested table
END;
/

```

Example 5-15 Nested Tables of Associative Arrays and Varrays of Strings

In this example, `aa1` is an associative array of associative arrays, and `ntb2` is a nested table of varrays of strings.



Live SQL:

You can view and run this example on Oracle Live SQL at [Nested Tables of Associative Arrays and Varrays of Strings](#)

```

DECLARE
  TYPE tb1 IS TABLE OF INTEGER INDEX BY PLS_INTEGER; -- associative arrays
  v4 tb1;
  v5 tb1;

  TYPE aa1 IS TABLE OF tb1 INDEX BY PLS_INTEGER; -- associative array of
  v2 aa1; -- associative arrays

  TYPE va1 IS VARRAY(10) OF VARCHAR2(20); -- varray of strings
  v1 va1 := va1('hello', 'world');

  TYPE ntb2 IS TABLE OF va1 INDEX BY PLS_INTEGER; -- associative array of varrays
  v3 ntb2;

BEGIN
  v4(1) := 34; -- populate associative array
  v4(2) := 46456;
  v4(456) := 343;

  v2(23) := v4; -- populate associative array of associative arrays

  v3(34) := va1(33, 456, 656, 343); -- populate associative array varrays

  v2(35) := v5; -- assign empty associative array to v2(35)
  v2(35)(2) := 78;
END;
/

```

5.9 Collection Comparisons

To determine if one collection variable is less than another (for example), you must define what less than means in that context and write a function that returns `TRUE` or `FALSE`.

You cannot compare associative array variables to the value `NULL` or to each other.

Except for [Comparing Nested Tables for Equality and Inequality](#), you cannot natively compare two collection variables with relational operators. This restriction also applies to implicit comparisons. For example, a collection variable cannot appear in a `DISTINCT`, `GROUP BY`, or `ORDER BY` clause.

Topics

- [Comparing Varray and Nested Table Variables to NULL](#)
- [Comparing Nested Tables for Equality and Inequality](#)
- [Comparing Nested Tables with SQL Multiset Conditions](#)

See Also:

- [Table 2-5](#)
- [PL/SQL Subprograms](#) for information about writing functions

5.9.1 Comparing Varray and Nested Table Variables to NULL

Use the `IS[NOT] NULL` operator when comparing to the `NULL` value.

You can compare varray and nested table variables to the value `NULL` with the "[IS \[NOT\] NULL Operator](#)", but not with the relational operators equal (`=`) and not equal (`<>`, `!=`, `~=`, or `^=`).

Example 5-16 Comparing Varray and Nested Table Variables to NULL

This example compares a varray variable and a nested table variable to `NULL` correctly.

Live SQL:

You can view and run this example on Oracle Live SQL at [Comparing Varray and Nested Table Variables to NULL](#)

```
DECLARE
  TYPE Foursome IS VARRAY(4) OF VARCHAR2(15); -- VARRAY type
  team Foursome;                               -- varray variable

  TYPE Roster IS TABLE OF VARCHAR2(15);       -- nested table type
  names Roster := Roster('Adams', 'Patel');    -- nested table variable

BEGIN
  IF team IS NULL THEN
    DBMS_OUTPUT.PUT_LINE('team IS NULL');
  ELSE
    DBMS_OUTPUT.PUT_LINE('team IS NOT NULL');
  END IF;

  IF names IS NOT NULL THEN
    DBMS_OUTPUT.PUT_LINE('names IS NOT NULL');
  ELSE
    DBMS_OUTPUT.PUT_LINE('names IS NULL');
  END IF;
END;
/
```

Result:

```
team IS NULL
names IS NOT NULL
```

5.9.2 Comparing Nested Tables for Equality and Inequality

Two nested table variables are equal if and only if they have the same set of elements (in any order).

If two nested table variables have the same nested table type, and that nested table type does not have elements of a record type, then you can compare the two variables for equality or inequality with the relational operators equal (=) and not equal (<>, !=, ~=, ^=).



See Also:

["Record Comparisons"](#)

Example 5-17 Comparing Nested Tables for Equality and Inequality

This example compares nested table variables for equality and inequality with relational operators.



Live SQL:

You can view and run this example on Oracle Live SQL at [Comparing Nested Tables for Equality and Inequality](#)

```
DECLARE
  TYPE dnames_tab IS TABLE OF VARCHAR2(30); -- element type is not record type

  dept_names1 dnames_tab :=
    dnames_tab('Shipping','Sales','Finance','Payroll');

  dept_names2 dnames_tab :=
    dnames_tab('Sales','Finance','Shipping','Payroll');

  dept_names3 dnames_tab :=
    dnames_tab('Sales','Finance','Payroll');

BEGIN
  IF dept_names1 = dept_names2 THEN
    DBMS_OUTPUT.PUT_LINE('dept_names1 = dept_names2');
  END IF;

  IF dept_names2 != dept_names3 THEN
    DBMS_OUTPUT.PUT_LINE('dept_names2 != dept_names3');
  END IF;
END;
/
```

Result:

```
dept_names1 = dept_names2
dept_names2 != dept_names3
```

5.9.3 Comparing Nested Tables with SQL Multiset Conditions

You can compare nested table variables, and test some of their properties, with SQL multiset conditions.

See Also:

- *Oracle Database SQL Language Reference* for more information about multiset conditions
- *Oracle Database SQL Language Reference* for details about `CARDINALITY` syntax
- *Oracle Database SQL Language Reference* for details about `SET` syntax

Example 5-18 Comparing Nested Tables with SQL Multiset Conditions

This example uses the SQL multiset conditions and two SQL functions that take nested table variable arguments, `CARDINALITY` and `SET`.

Live SQL:

You can view and run this example on Oracle Live SQL at [Comparing Nested Tables with SQL Multiset Conditions](#)

```
DECLARE
  TYPE nested_typ IS TABLE OF NUMBER;
  nt1 nested_typ := nested_typ(1,2,3);
  nt2 nested_typ := nested_typ(3,2,1);
  nt3 nested_typ := nested_typ(2,3,1,3);
  nt4 nested_typ := nested_typ(1,2,4);

  PROCEDURE testify (
    truth BOOLEAN := NULL,
    quantity NUMBER := NULL
  ) IS
  BEGIN
    IF truth IS NOT NULL THEN
      DBMS_OUTPUT.PUT_LINE (
        CASE truth
          WHEN TRUE THEN 'True'
          WHEN FALSE THEN 'False'
        END
      );
    END IF;
    IF quantity IS NOT NULL THEN
      DBMS_OUTPUT.PUT_LINE(quantity);
    END IF;
  END;
BEGIN
```

```

testify(truth => (nt1 IN (nt2,nt3,nt4)));      -- condition
testify(truth => (nt1 SUBMULTISET OF nt3));  -- condition
testify(truth => (nt1 NOT SUBMULTISET OF nt4)); -- condition
testify(truth => (4 MEMBER OF nt1));        -- condition
testify(truth => (nt3 IS A SET));          -- condition
testify(truth => (nt3 IS NOT A SET));      -- condition
testify(truth => (nt1 IS EMPTY));         -- condition
testify(quantity => (CARDINALITY(nt3)));    -- function
testify(quantity => (CARDINALITY(SET(nt3)))); -- 2 functions
END;
/

```

Result:

```

True
True
True
False
False
True
False
4
3

```

5.10 Collection Methods

A collection method is a PL/SQL subprogram—either a function that returns information about a collection or a procedure that operates on a collection. Collection methods make collections easier to use and your applications easier to maintain.

Table 5-2 summarizes the collection methods.



Note:

With a null collection, `EXISTS` is the only collection method that does not raise the predefined exception `COLLECTION_IS_NULL`.

Table 5-2 Collection Methods

Method	Type	Description
DELETE	Procedure	Deletes elements from collection.
TRIM	Procedure	Deletes elements from end of varray or nested table.
EXTEND	Procedure	Adds elements to end of varray or nested table.
EXISTS	Function	Returns <code>TRUE</code> if and only if specified element of varray or nested table exists.
FIRST	Function	Returns first index in collection.
LAST	Function	Returns last index in collection.
COUNT	Function	Returns number of elements in collection.
LIMIT	Function	Returns maximum number of elements that collection can have.
PRIOR	Function	Returns index that precedes specified index.

Table 5-2 (Cont.) Collection Methods

Method	Type	Description
NEXT	Function	Returns index that succeeds specified index.

The basic syntax of a collection method invocation is:

```
collection_name.method
```

For detailed syntax, see "[Collection Method Invocation](#)".

A collection method invocation can appear anywhere that an invocation of a PL/SQL subprogram of its type (function or procedure) can appear, except in a SQL statement. (For general information about PL/SQL subprograms, see [PL/SQL Subprograms](#).)

In a subprogram, a collection parameter assumes the properties of the argument bound to it. You can apply collection methods to such parameters. For varray parameters, the value of `LIMIT` is always derived from the parameter type definition, regardless of the parameter mode.

Topics

- [DELETE Collection Method](#)
- [TRIM Collection Method](#)
- [EXTEND Collection Method](#)
- [EXISTS Collection Method](#)
- [FIRST and LAST Collection Methods](#)
- [COUNT Collection Method](#)
- [LIMIT Collection Method](#)
- [PRIOR and NEXT Collection Methods](#)

5.10.1 DELETE Collection Method

`DELETE` is a procedure that deletes elements from a collection.

This method has these forms:

- `DELETE` deletes all elements from a collection of any type.
This operation immediately frees the memory allocated to the deleted elements.
- From an associative array or nested table (but not a varray):
 - `DELETE (n)` deletes the element whose index is *n*, if that element exists; otherwise, it does nothing.
 - `DELETE (m, n)` deletes all elements whose indexes are in the range *m..n*, if both *m* and *n* exist and $m \leq n$; otherwise, it does nothing.

For these two forms of `DELETE`, PL/SQL keeps placeholders for the deleted elements. Therefore, the deleted elements are included in the internal size of the collection, and you can restore a deleted element by assigning a valid value to it.

Example 5-19 DELETE Method with Nested Table

This example declares a nested table variable, initializing it with six elements; deletes and then restores the second element; deletes a range of elements and then restores one of them; and then deletes all elements. The restored elements occupy the same memory as the corresponding deleted elements. The procedure `print_nt` prints the nested table variable after initialization and after each `DELETE` operation. The type `nt_type` and procedure `print_nt` are defined in [Example 5-6](#).

```
DECLARE
  nt nt_type := nt_type(11, 22, 33, 44, 55, 66);
BEGIN
  print_nt(nt);

  nt.DELETE(2);      -- Delete second element
  print_nt(nt);

  nt(2) := 2222;    -- Restore second element
  print_nt(nt);

  nt.DELETE(2, 4);  -- Delete range of elements
  print_nt(nt);

  nt(3) := 3333;    -- Restore third element
  print_nt(nt);

  nt.DELETE;        -- Delete all elements
  print_nt(nt);
END;
/
```

Result:

```
nt.(1) = 11
nt.(2) = 22
nt.(3) = 33
nt.(4) = 44
nt.(5) = 55
nt.(6) = 66
---
nt.(1) = 11
nt.(3) = 33
nt.(4) = 44
nt.(5) = 55
nt.(6) = 66
---
nt.(1) = 11
nt.(2) = 2222
nt.(3) = 33
nt.(4) = 44
nt.(5) = 55
nt.(6) = 66
---
nt.(1) = 11
nt.(5) = 55
nt.(6) = 66
---
nt.(1) = 11
nt.(3) = 3333
nt.(5) = 55
nt.(6) = 66
```



```

---
nt is empty
---

```

Example 5-20 DELETE Method with Associative Array Indexed by String

This example populates an associative array indexed by string and deletes all elements, which frees the memory allocated to them. Next, the example replaces the deleted elements—that is, adds new elements that have the same indexes as the deleted elements. The new replacement elements do not occupy the same memory as the corresponding deleted elements. Finally, the example deletes one element and then a range of elements. The procedure `print_aa_str` shows the effects of the operations.

```

DECLARE
  TYPE aa_type_str IS TABLE OF INTEGER INDEX BY VARCHAR2(10);
  aa_str aa_type_str;

  PROCEDURE print_aa_str IS
    i VARCHAR2(10);
  BEGIN
    i := aa_str.FIRST;

    IF i IS NULL THEN
      DBMS_OUTPUT.PUT_LINE('aa_str is empty');
    ELSE
      WHILE i IS NOT NULL LOOP
        DBMS_OUTPUT.PUT('aa_str.( ' || i || ' ) = ');
        DBMS_OUTPUT.PUT_LINE(NVL(TO_CHAR(aa_str(i)), 'NULL'));
        i := aa_str.NEXT(i);
      END LOOP;
    END IF;

    DBMS_OUTPUT.PUT_LINE('---');
  END print_aa_str;

BEGIN
  aa_str('M') := 13;
  aa_str('Z') := 26;
  aa_str('C') := 3;
  print_aa_str;

  aa_str.DELETE; -- Delete all elements
  print_aa_str;

  aa_str('M') := 13; -- Replace deleted element with same value
  aa_str('Z') := 260; -- Replace deleted element with new value
  aa_str('C') := 30; -- Replace deleted element with new value
  aa_str('W') := 23; -- Add new element
  aa_str('J') := 10; -- Add new element
  aa_str('N') := 14; -- Add new element
  aa_str('P') := 16; -- Add new element
  aa_str('W') := 23; -- Add new element
  aa_str('J') := 10; -- Add new element
  print_aa_str;

  aa_str.DELETE('C'); -- Delete one element
  print_aa_str;

  aa_str.DELETE('N','W'); -- Delete range of elements
  print_aa_str;

```

```
aa_str.DELETE('Z','M'); -- Does nothing
print_aa_str;
END;
/
```

Result:

```
aa_str.(C) = 3
aa_str.(M) = 13
aa_str.(Z) = 26
---
aa_str is empty
---
aa_str.(C) = 30
aa_str.(J) = 10
aa_str.(M) = 13
aa_str.(N) = 14
aa_str.(P) = 16
aa_str.(W) = 23
aa_str.(Z) = 260
---
aa_str.(J) = 10
aa_str.(M) = 13
aa_str.(N) = 14
aa_str.(P) = 16
aa_str.(W) = 23
aa_str.(Z) = 260
---
aa_str.(J) = 10
aa_str.(M) = 13
aa_str.(Z) = 260
---
aa_str.(J) = 10
aa_str.(M) = 13
aa_str.(Z) = 260
---
```

5.10.2 TRIM Collection Method

TRIM is a procedure that deletes elements from the end of a varray or nested table.

This method has these forms:

- TRIM removes one element from the end of the collection, if the collection has at least one element; otherwise, it raises the predefined exception `SUBSCRIPT_BEYOND_COUNT`.
- TRIM(*n*) removes *n* elements from the end of the collection, if there are at least *n* elements at the end; otherwise, it raises the predefined exception `SUBSCRIPT_BEYOND_COUNT`.

TRIM operates on the internal size of a collection. That is, if DELETE deletes an element but keeps a placeholder for it, then TRIM considers the element to exist. Therefore, TRIM can delete a deleted element.

PL/SQL does not keep placeholders for trimmed elements. Therefore, trimmed elements are not included in the internal size of the collection, and you cannot restore a trimmed element by assigning a valid value to it.

▲ Caution:

Do not depend on interaction between `TRIM` and `DELETE`. Treat nested tables like either fixed-size arrays (and use only `DELETE`) or stacks (and use only `TRIM` and `EXTEND`).

Example 5-21 TRIM Method with Nested Table

This example declares a nested table variable, initializing it with six elements; trims the last element; deletes the fourth element; and then trims the last two elements—one of which is the deleted fourth element. The procedure `print_nt` prints the nested table variable after initialization and after the `TRIM` and `DELETE` operations. The type `nt_type` and procedure `print_nt` are defined in [Example 5-6](#).

```
DECLARE
  nt nt_type := nt_type(11, 22, 33, 44, 55, 66);
BEGIN
  print_nt(nt);

  nt.TRIM;          -- Trim last element
  print_nt(nt);

  nt.DELETE(4);    -- Delete fourth element
  print_nt(nt);

  nt.TRIM(2);      -- Trim last two elements
  print_nt(nt);
END;
/
```

Result:

```
nt.(1) = 11
nt.(2) = 22
nt.(3) = 33
nt.(4) = 44
nt.(5) = 55
nt.(6) = 66
---
nt.(1) = 11
nt.(2) = 22
nt.(3) = 33
nt.(4) = 44
nt.(5) = 55
---
nt.(1) = 11
nt.(2) = 22
nt.(3) = 33
nt.(5) = 55
---
nt.(1) = 11
nt.(2) = 22
nt.(3) = 33
---
```

5.10.3 EXTEND Collection Method

`EXTEND` is a procedure that adds elements to the end of a varray or nested table.

The collection can be empty, but not null. (To make a collection empty or add elements to a null collection, use a constructor. For more information, see ["Collection Constructors"](#).)

The `EXTEND` method has these forms:

- `EXTEND` appends one null element to the collection.
- `EXTEND(n)` appends n null elements to the collection.
- `EXTEND(n,i)` appends n copies of the i th element to the collection.

Note:

`EXTEND(n,i)` is the only form that you can use for a collection whose elements have the `NOT NULL` constraint.

`EXTEND` operates on the internal size of a collection. That is, if `DELETE` deletes an element but keeps a placeholder for it, then `EXTEND` considers the element to exist.

Example 5-22 EXTEND Method with Nested Table

This example declares a nested table variable, initializing it with three elements; appends two copies of the first element; deletes the fifth (last) element; and then appends one null element. Because `EXTEND` considers the deleted fifth element to exist, the appended null element is the sixth element. The procedure `print_nt` prints the nested table variable after initialization and after the `EXTEND` and `DELETE` operations. The type `nt_type` and procedure `print_nt` are defined in [Example 5-6](#).

```
DECLARE
  nt nt_type := nt_type(11, 22, 33);
BEGIN
  print_nt(nt);

  nt.EXTEND(2,1); -- Append two copies of first element
  print_nt(nt);

  nt.DELETE(5);  -- Delete fifth element
  print_nt(nt);

  nt.EXTEND;     -- Append one null element
  print_nt(nt);
END;
/
```

Result:

```
nt.(1) = 11
nt.(2) = 22
nt.(3) = 33
---
nt.(1) = 11
nt.(2) = 22
nt.(3) = 33
```

```

nt.(4) = 11
nt.(5) = 11
---
nt.(1) = 11
nt.(2) = 22
nt.(3) = 33
nt.(4) = 11
---
nt.(1) = 11
nt.(2) = 22
nt.(3) = 33
nt.(4) = 11
nt.(6) = NULL
---
```

5.10.4 EXISTS Collection Method

`EXISTS` is a function that tells you whether the specified element of a varray or nested table exists.

`EXISTS(n)` returns `TRUE` if the *n*th element of the collection exists and `FALSE` otherwise. If *n* is out of range, `EXISTS` returns `FALSE` instead of raising the predefined exception `SUBSCRIPT_OUTSIDE_LIMIT`.

For a deleted element, `EXISTS(n)` returns `FALSE`, even if `DELETE` kept a placeholder for it.

Example 5-23 EXISTS Method with Nested Table

This example initializes a nested table with four elements, deletes the second element, and prints either the value or status of elements 1 through 6.

```

DECLARE
  TYPE NumList IS TABLE OF INTEGER;
  n NumList := NumList(1,3,5,7);
BEGIN
  n.DELETE(2); -- Delete second element

  FOR i IN 1..6 LOOP
    IF n.EXISTS(i) THEN
      DBMS_OUTPUT.PUT_LINE('n(' || i || ') = ' || n(i));
    ELSE
      DBMS_OUTPUT.PUT_LINE('n(' || i || ') does not exist');
    END IF;
  END LOOP;
END;
/
```

Result:

```

n(1) = 1
n(2) does not exist
n(3) = 5
n(4) = 7
n(5) does not exist
n(6) does not exist
```

5.10.5 FIRST and LAST Collection Methods

FIRST and LAST are functions.

If the collection has at least one element, FIRST and LAST return the indexes of the first and last elements, respectively (ignoring deleted elements, even if DELETE kept placeholders for them). If the collection has only one element, FIRST and LAST return the same index. If the collection is empty, FIRST and LAST return NULL.

Topics

- [FIRST and LAST Methods for Associative Array](#)
- [FIRST and LAST Methods for Varray](#)
- [FIRST and LAST Methods for Nested Table](#)

5.10.5.1 FIRST and LAST Methods for Associative Array

For an associative array indexed by PLS_INTEGER, the first and last elements are those with the smallest and largest indexes, respectively. For an associative array indexed by string, the first and last elements are those with the lowest and highest key values, respectively.

Key values are in sorted order (for more information, see "[NLS Parameter Values Affect Associative Arrays Indexed by String](#)").

Example 5-24 FIRST and LAST Values for Associative Array Indexed by PLS_INTEGER

This example shows the values of FIRST and LAST for an associative array indexed by PLS_INTEGER, deletes the first and last elements, and shows the values of FIRST and LAST again.

```
DECLARE
  TYPE aa_type_int IS TABLE OF INTEGER INDEX BY PLS_INTEGER;
  aa_int aa_type_int;

  PROCEDURE print_first_and_last IS
  BEGIN
    DBMS_OUTPUT.PUT_LINE('FIRST = ' || aa_int.FIRST);
    DBMS_OUTPUT.PUT_LINE('LAST = ' || aa_int.LAST);
  END print_first_and_last;

BEGIN
  aa_int(1) := 3;
  aa_int(2) := 6;
  aa_int(3) := 9;
  aa_int(4) := 12;

  DBMS_OUTPUT.PUT_LINE('Before deletions:');
  print_first_and_last;

  aa_int.DELETE(1);
  aa_int.DELETE(4);

  DBMS_OUTPUT.PUT_LINE('After deletions:');
  print_first_and_last;
```

```
END;  
/
```

Result:

```
Before deletions:  
FIRST = 1  
LAST = 4  
After deletions:  
FIRST = 2  
LAST = 3
```

Example 5-25 FIRST and LAST Values for Associative Array Indexed by String

This example shows the values of `FIRST` and `LAST` for an associative array indexed by string, deletes the first and last elements, and shows the values of `FIRST` and `LAST` again.

```
DECLARE  
  TYPE aa_type_str IS TABLE OF INTEGER INDEX BY VARCHAR2(10);  
  aa_str aa_type_str;  
  
  PROCEDURE print_first_and_last IS  
  BEGIN  
    DBMS_OUTPUT.PUT_LINE('FIRST = ' || aa_str.FIRST);  
    DBMS_OUTPUT.PUT_LINE('LAST = ' || aa_str.LAST);  
  END print_first_and_last;  
  
BEGIN  
  aa_str('Z') := 26;  
  aa_str('A') := 1;  
  aa_str('K') := 11;  
  aa_str('R') := 18;  
  
  DBMS_OUTPUT.PUT_LINE('Before deletions:');  
  print_first_and_last;  
  
  aa_str.DELETE('A');  
  aa_str.DELETE('Z');  
  
  DBMS_OUTPUT.PUT_LINE('After deletions:');  
  print_first_and_last;  
END;  
/
```

Result:

```
Before deletions:  
FIRST = A  
LAST = Z  
After deletions:  
FIRST = K  
LAST = R
```

5.10.5.2 FIRST and LAST Methods for Varray

For a varray that is not empty, `FIRST` always returns 1. For every varray, `LAST` always equals `COUNT`.

Example 5-26 Printing Varray with FIRST and LAST in FOR LOOP

This example prints the varray `team` using a `FOR LOOP` statement with the bounds `team.FIRST` and `team.LAST`. Because a varray is always dense, `team(i)` inside the loop always exists.

```
DECLARE
  TYPE team_type IS VARRAY(4) OF VARCHAR2(15);
  team team_type;

  PROCEDURE print_team (heading VARCHAR2)
  IS
  BEGIN
    DBMS_OUTPUT.PUT_LINE(heading);

    IF team IS NULL THEN
      DBMS_OUTPUT.PUT_LINE('Does not exist');
    ELSIF team.FIRST IS NULL THEN
      DBMS_OUTPUT.PUT_LINE('Has no members');
    ELSE
      FOR i IN team.FIRST..team.LAST LOOP
        DBMS_OUTPUT.PUT_LINE(i || '. ' || team(i));
      END LOOP;
    END IF;

    DBMS_OUTPUT.PUT_LINE('---');
  END;

BEGIN
  print_team('Team Status:');

  team := team_type(); -- Team is funded, but nobody is on it.
  print_team('Team Status:');

  team := team_type('John', 'Mary'); -- Put 2 members on team.
  print_team('Initial Team:');

  team := team_type('Arun', 'Amitha', 'Allan', 'Mae'); -- Change team.
  print_team('New Team:');
END;
/
```

Result:

```
Team Status:
Does not exist
---
Team Status:
Has no members
---
Initial Team:
1. John
2. Mary
---
New Team:
1. Arun
2. Amitha
3. Allan
4. Mae
---
```

Related Topic

- [Example 5-28](#)

5.10.5.3 FIRST and LAST Methods for Nested Table

For a nested table, `LAST` equals `COUNT` unless you delete elements from its middle, in which case `LAST` is larger than `COUNT`.

Example 5-27 Printing Nested Table with FIRST and LAST in FOR LOOP

This example prints the nested table `team` using a `FOR LOOP` statement with the bounds `team.FIRST` and `team.LAST`. Because a nested table can be sparse, the `FOR LOOP` statement prints `team(i)` only if `team.EXISTS(i)` is `TRUE`.

```

DECLARE
  TYPE team_type IS TABLE OF VARCHAR2(15);
  team team_type;

  PROCEDURE print_team (heading VARCHAR2) IS
  BEGIN
    DBMS_OUTPUT.PUT_LINE(heading);

    IF team IS NULL THEN
      DBMS_OUTPUT.PUT_LINE('Does not exist');
    ELSIF team.FIRST IS NULL THEN
      DBMS_OUTPUT.PUT_LINE('Has no members');
    ELSE
      FOR i IN team.FIRST..team.LAST LOOP
        DBMS_OUTPUT.PUT(i || '. ');
        IF team.EXISTS(i) THEN
          DBMS_OUTPUT.PUT_LINE(team(i));
        ELSE
          DBMS_OUTPUT.PUT_LINE('(to be hired)');
        END IF;
      END LOOP;
    END IF;

    DBMS_OUTPUT.PUT_LINE('---');
  END;

BEGIN
  print_team('Team Status:');

  team := team_type(); -- Team is funded, but nobody is on it.
  print_team('Team Status:');

  team := team_type('Arun', 'Amitha', 'Allan', 'Mae'); -- Add members.
  print_team('Initial Team:');

  team.DELETE(2,3); -- Remove 2nd and 3rd members.
  print_team('Current Team:');
END;
/

```

Result:

```

Team Status:
Does not exist

```

```

---
Team Status:
Has no members
---
Initial Team:
1. Arun
2. Amitha
3. Allan
4. Mae
---
Current Team:
1. Arun
2. (to be hired)
3. (to be hired)
4. Mae
---
```

Related Topic

- [Example 5-29](#)

5.10.6 COUNT Collection Method

`COUNT` is a function that returns the number of elements in the collection (ignoring deleted elements, even if `DELETE` kept placeholders for them).

Topics

- [COUNT Method for Varray](#)
- [COUNT Method for Nested Table](#)

5.10.6.1 COUNT Method for Varray

For a varray, `COUNT` always equals `LAST`. If you increase or decrease the size of a varray (with the `EXTEND` or `TRIM` method), the value of `COUNT` changes.

Example 5-28 COUNT and LAST Values for Varray

This example shows the values of `COUNT` and `LAST` for a varray after initialization with four elements, after `EXTEND(3)`, and after `TRIM(5)`.

```

DECLARE
  TYPE NumList IS VARRAY(10) OF INTEGER;
  n NumList := NumList(1,3,5,7);

  PROCEDURE print_count_and_last IS
  BEGIN
    DBMS_OUTPUT.PUT('n.COUNT = ' || n.COUNT || ', ');
    DBMS_OUTPUT.PUT_LINE('n.LAST = ' || n.LAST);
  END print_count_and_last;

BEGIN
  print_count_and_last;

  n.EXTEND(3);
  print_count_and_last;

  n.TRIM(5);
  print_count_and_last;
```

```
END;
/
```

Result:

```
n.COUNT = 4, n.LAST = 4
n.COUNT = 7, n.LAST = 7
n.COUNT = 2, n.LAST = 2
```

5.10.6.2 COUNT Method for Nested Table

For a nested table, `COUNT` equals `LAST` unless you delete elements from the middle of the nested table, in which case `COUNT` is smaller than `LAST`.

Example 5-29 COUNT and LAST Values for Nested Table

This example shows the values of `COUNT` and `LAST` for a nested table after initialization with four elements, after deleting the third element, and after adding two null elements to the end. Finally, the example prints the status of elements 1 through 8.

```
DECLARE
  TYPE NumList IS TABLE OF INTEGER;
  n NumList := NumList(1,3,5,7);

  PROCEDURE print_count_and_last IS
  BEGIN
    DBMS_OUTPUT.PUT('n.COUNT = ' || n.COUNT || ', ');
    DBMS_OUTPUT.PUT_LINE('n.LAST = ' || n.LAST);
  END print_count_and_last;

BEGIN
  print_count_and_last;

  n.DELETE(3); -- Delete third element
  print_count_and_last;

  n.EXTEND(2); -- Add two null elements to end
  print_count_and_last;

  FOR i IN 1..8 LOOP
    IF n.EXISTS(i) THEN
      IF n(i) IS NOT NULL THEN
        DBMS_OUTPUT.PUT_LINE('n(' || i || ') = ' || n(i));
      ELSE
        DBMS_OUTPUT.PUT_LINE('n(' || i || ') = NULL');
      END IF;
    ELSE
      DBMS_OUTPUT.PUT_LINE('n(' || i || ') does not exist');
    END IF;
  END LOOP;
END;
/
```

Result:

```
n.COUNT = 4, n.LAST = 4
n.COUNT = 3, n.LAST = 4
n.COUNT = 5, n.LAST = 6
n(1) = 1
n(2) = 3
n(3) does not exist
```

```
n(4) = 7
n(5) = NULL
n(6) = NULL
n(7) does not exist
n(8) does not exist
```

5.10.7 LIMIT Collection Method

LIMIT is a function that returns the maximum number of elements that the collection can have. If the collection has no maximum number of elements, **LIMIT** returns **NULL**. Only a varray has a maximum size.

Example 5-30 LIMIT and COUNT Values for Different Collection Types

This example prints the values of **LIMIT** and **COUNT** for an associative array with four elements, a varray with two elements, and a nested table with three elements.

```
DECLARE
  TYPE aa_type IS TABLE OF INTEGER INDEX BY PLS_INTEGER;
  aa aa_type;                                     -- associative array

  TYPE va_type IS VARRAY(4) OF INTEGER;
  va va_type := va_type(2,4);                   -- varray

  TYPE nt_type IS TABLE OF INTEGER;
  nt nt_type := nt_type(1,3,5);                 -- nested table

BEGIN
  aa(1):=3; aa(2):=6; aa(3):=9; aa(4):= 12;

  DBMS_OUTPUT.PUT('aa.COUNT = ');
  DBMS_OUTPUT.PUT_LINE(NVL(TO_CHAR(aa.COUNT), 'NULL'));

  DBMS_OUTPUT.PUT('aa.LIMIT = ');
  DBMS_OUTPUT.PUT_LINE(NVL(TO_CHAR(aa.LIMIT), 'NULL'));

  DBMS_OUTPUT.PUT('va.COUNT = ');
  DBMS_OUTPUT.PUT_LINE(NVL(TO_CHAR(va.COUNT), 'NULL'));

  DBMS_OUTPUT.PUT('va.LIMIT = ');
  DBMS_OUTPUT.PUT_LINE(NVL(TO_CHAR(va.LIMIT), 'NULL'));

  DBMS_OUTPUT.PUT('nt.COUNT = ');
  DBMS_OUTPUT.PUT_LINE(NVL(TO_CHAR(nt.COUNT), 'NULL'));

  DBMS_OUTPUT.PUT('nt.LIMIT = ');
  DBMS_OUTPUT.PUT_LINE(NVL(TO_CHAR(nt.LIMIT), 'NULL'));

END;
/
```

Result:

```
aa.COUNT = 4
aa.LIMIT = NULL
va.COUNT = 2
va.LIMIT = 4
nt.COUNT = 3
nt.LIMIT = NULL
```

5.10.8 PRIOR and NEXT Collection Methods

`PRIOR` and `NEXT` are functions that let you move backward and forward in the collection (ignoring deleted elements, even if `DELETE` kept placeholders for them). These methods are useful for traversing sparse collections.

Given an index:

- `PRIOR` returns the index of the preceding existing element of the collection, if one exists. Otherwise, `PRIOR` returns `NULL`.

For any collection `c`, `c.PRIOR(c.FIRST)` returns `NULL`.

- `NEXT` returns the index of the succeeding existing element of the collection, if one exists. Otherwise, `NEXT` returns `NULL`.

For any collection `c`, `c.NEXT(c.LAST)` returns `NULL`.

The given index need not exist. However, if the collection `c` is a varray, and the index exceeds `c.LIMIT`, then:

- `c.PRIOR(index)` returns `c.LAST`.
- `c.NEXT(index)` returns `NULL`.

For example:

```
DECLARE
  TYPE Arr_Type IS VARRAY(10) OF NUMBER;
  v_Numbers Arr_Type := Arr_Type();
BEGIN
  v_Numbers.EXTEND(4);

  v_Numbers (1) := 10;
  v_Numbers (2) := 20;
  v_Numbers (3) := 30;
  v_Numbers (4) := 40;

  DBMS_OUTPUT.PUT_LINE(NVL(v_Numbers.prior (3400), -1));
  DBMS_OUTPUT.PUT_LINE(NVL(v_Numbers.next (3400), -1));
END;
/
```

Result:

```
4
-1
```

For an associative array indexed by string, the prior and next indexes are determined by key values, which are in sorted order (for more information, see ["NLS Parameter Values Affect Associative Arrays Indexed by String"](#)). [Example 5-1](#) uses `FIRST`, `NEXT`, and a `WHILE LOOP` statement to print the elements of an associative array.

Example 5-31 PRIOR and NEXT Methods

This example initializes a nested table with six elements, deletes the fourth element, and then shows the values of `PRIOR` and `NEXT` for elements 1 through 7. Elements 4 and 7 do not exist. Element 2 exists, despite its null value.

```

DECLARE
  TYPE nt_type IS TABLE OF NUMBER;
  nt nt_type := nt_type(18, NULL, 36, 45, 54, 63);

BEGIN
  nt.DELETE(4);
  DBMS_OUTPUT.PUT_LINE('nt(4) was deleted.');
```

```

  FOR i IN 1..7 LOOP
    DBMS_OUTPUT.PUT('nt.PRIOR(' || i || ') = ');
    DBMS_OUTPUT.PUT_LINE(NVL(TO_CHAR(nt.PRIOR(i)), 'NULL'));

    DBMS_OUTPUT.PUT('nt.NEXT(' || i || ') = ');
    DBMS_OUTPUT.PUT_LINE(NVL(TO_CHAR(nt.NEXT(i)), 'NULL'));
  END LOOP;
END;
/
```

Result:

```

nt(4) was deleted.
nt.PRIOR(1) = NULL
nt.NEXT(1)  = 2
nt.PRIOR(2) = 1
nt.NEXT(2)  = 3
nt.PRIOR(3) = 2
nt.NEXT(3)  = 5
nt.PRIOR(4) = 3
nt.NEXT(4)  = 5
nt.PRIOR(5) = 3
nt.NEXT(5)  = 6
nt.PRIOR(6) = 5
nt.NEXT(6)  = NULL
nt.PRIOR(7) = 6
nt.NEXT(7)  = NULL
```

Example 5-32 Printing Elements of Sparse Nested Table

This example prints the elements of a sparse nested table from first to last, using `FIRST` and `NEXT`, and from last to first, using `LAST` and `PRIOR`.

```

DECLARE
  TYPE NumList IS TABLE OF NUMBER;
  n NumList := NumList(1, 2, NULL, NULL, 5, NULL, 7, 8, 9, NULL);
  idx INTEGER;

BEGIN
  DBMS_OUTPUT.PUT_LINE('First to last:');
  idx := n.FIRST;
  WHILE idx IS NOT NULL LOOP
    DBMS_OUTPUT.PUT('n(' || idx || ') = ');
    DBMS_OUTPUT.PUT_LINE(NVL(TO_CHAR(n(idx)), 'NULL'));
    idx := n.NEXT(idx);
  END LOOP;

  DBMS_OUTPUT.PUT_LINE('-----');

  DBMS_OUTPUT.PUT_LINE('Last to first:');
  idx := n.LAST;
  WHILE idx IS NOT NULL LOOP
    DBMS_OUTPUT.PUT('n(' || idx || ') = ');
```

```

        DBMS_OUTPUT.PUT_LINE(NVL(TO_CHAR(n(idx)), 'NULL'));
        idx := n.PRIOR(idx);
    END LOOP;
END;
/

```

Result:

First to last:

```

n(1) = 1
n(2) = 2
n(3) = NULL
n(4) = NULL
n(5) = 5
n(6) = NULL
n(7) = 7
n(8) = 8
n(9) = 9
n(10) = NULL
-----

```

Last to first:

```

n(10) = NULL
n(9) = 9
n(8) = 8
n(7) = 7
n(6) = NULL
n(5) = 5
n(4) = NULL
n(3) = NULL
n(2) = 2
n(1) = 1

```

5.11 Collection Types Defined in Package Specifications

A collection type defined in a package specification is incompatible with an identically defined local or standalone collection type.

**Note:**

The examples in this topic define packages and procedures, which are explained in [PL/SQL Packages](#) and [PL/SQL Subprograms](#), respectively.

Example 5-33 Identically Defined Package and Local Collection Types

In this example, the package specification and the anonymous block define the collection type `NumList` identically. The package defines a procedure, `print_numlist`, which has a `NumList` parameter. The anonymous block declares the variable `n1` of the type `pkg.NumList` (defined in the package) and the variable `n2` of the type `NumList` (defined in the block). The anonymous block can pass `n1` to `print_numlist`, but it cannot pass `n2` to `print_numlist`.

 **Live SQL:**

You can view and run this example on Oracle Live SQL at [Identically Defined Package and Local Collection Types](#)

```
CREATE OR REPLACE PACKAGE pkg AS
  TYPE NumList IS TABLE OF NUMBER;
  PROCEDURE print_numlist (nums NumList);
END pkg;
/
CREATE OR REPLACE PACKAGE BODY pkg AS
  PROCEDURE print_numlist (nums NumList) IS
  BEGIN
    FOR i IN nums.FIRST..nums.LAST LOOP
      DBMS_OUTPUT.PUT_LINE(nums(i));
    END LOOP;
  END;
END pkg;
/
DECLARE
  TYPE NumList IS TABLE OF NUMBER; -- local type identical to package type
  n1 pkg.NumList := pkg.NumList(2,4); -- package type
  n2   NumList :=   NumList(6,8); -- local type
BEGIN
  pkg.print_numlist(n1); -- succeeds
  pkg.print_numlist(n2); -- fails
END;
/
```

Result:

```
pkg.print_numlist(n2); -- fails
*
ERROR at line 7:
ORA-06550: line 7, column 3:
PLS-00306: wrong number or types of arguments in call to 'PRINT_NUMLIST'
ORA-06550: line 7, column 3:
PL/SQL: Statement ignored
```

Example 5-34 Identically Defined Package and Standalone Collection Types

This example defines a standalone collection type `NumList` that is identical to the collection type `NumList` defined in the package specification in [Example 5-33](#). The anonymous block declares the variable `n1` of the type `pkg.NumList` (defined in the package) and the variable `n2` of the standalone type `NumList`. The anonymous block can pass `n1` to `print_numlist`, but it cannot pass `n2` to `print_numlist`.

 **Live SQL:**

You can view and run this example on Oracle Live SQL at [Identically Defined Package and Standalone Collection Types](#)

```
CREATE OR REPLACE TYPE NumList IS TABLE OF NUMBER;
  -- standalone collection type identical to package type
```



```
/
DECLARE
  n1 pkg.NumList := pkg.NumList(2,4); -- package type
  n2   NumList :=   NumList(6,8); -- standalone type

BEGIN
  pkg.print_numlist(n1); -- succeeds
  pkg.print_numlist(n2); -- fails
END;
/
```

Result:

```
  pkg.print_numlist(n2); -- fails
  *
ERROR at line 7:
ORA-06550: line 7, column 3:
PLS-00306: wrong number or types of arguments in call to 'PRINT_NUMLIST'
ORA-06550: line 7, column 3:
PL/SQL: Statement ignored
```

5.12 Record Variables

You can create a record variable in any of these ways:

- Define a `RECORD` type and then declare a variable of that type.
- Use `%ROWTYPE` to declare a record variable that represents either a full or partial row of a database table or view.
- Use `%TYPE` to declare a record variable of the same type as a previously declared record variable.

For syntax and semantics, see "[Record Variable Declaration](#)".

Topics

- [Initial Values of Record Variables](#)
- [Declaring Record Constants](#)
- [RECORD Types](#)
- [Declaring Items using the %ROWTYPE Attribute](#)

5.12.1 Initial Values of Record Variables

For a record variable of a `RECORD` type, the initial value of each field is `NULL` unless you specify a different initial value for it when you define the type.

For a record variable declared with `%ROWTYPE` or `%TYPE`, the initial value of each field is `NULL`. The variable does not inherit the initial value of the referenced item.

5.12.2 Declaring Record Constants

When declaring a record constant, you must create a function that populates the record with its initial value and then invoke the function in the constant declaration.

Example 5-35 Declaring Record Constant

This example creates a function that populates the record with its initial value and then invoke the function in the constant declaration.

Live SQL:

You can view and run this example on Oracle Live SQL at [Declaring Record Constant](#)

```

CREATE OR REPLACE PACKAGE My_Types AUTHID CURRENT_USER IS
  TYPE My_Rec IS RECORD (a NUMBER, b NUMBER);
  FUNCTION Init_My_Rec RETURN My_Rec;
END My_Types;
/
CREATE OR REPLACE PACKAGE BODY My_Types IS
  FUNCTION Init_My_Rec RETURN My_Rec IS
    Rec My_Rec;
  BEGIN
    Rec.a := 0;
    Rec.b := 1;
    RETURN Rec;
  END Init_My_Rec;
END My_Types;
/
DECLARE
  r CONSTANT My_Types.My_Rec := My_Types.Init_My_Rec();
BEGIN
  DBMS_OUTPUT.PUT_LINE('r.a = ' || r.a);
  DBMS_OUTPUT.PUT_LINE('r.b = ' || r.b);
END;
/

```

Result:

```

r.a = 0
r.b = 1

```

PL/SQL procedure successfully completed.

5.12.3 RECORD Types

A `RECORD` type defined in a PL/SQL block is a **local type**. It is available only in the block, and is stored in the database only if the block is in a standalone or package subprogram.

A `RECORD` type defined in a package specification is a **public item**. You can reference it from outside the package by qualifying it with the package name (*package_name.type_name*). It is stored in the database until you drop the package with the `DROP PACKAGE` statement.

You cannot create a `RECORD` type at schema level. Therefore, a `RECORD` type cannot be an ADT attribute data type.

To define a `RECORD` type, specify its name and define its fields. To define a field, specify its name and data type. By default, the initial value of a field is `NULL`. You can specify the `NOT NULL` constraint for a field, in which case you must also specify a non-`NULL` initial value. Without the `NOT NULL` constraint, a non-`NULL` initial value is optional.

A `RECORD` type defined in a package specification is incompatible with an identically defined local `RECORD` type.

 **See Also:**

- [PL/SQL Packages](#)
- [PL/SQL Subprograms](#)
- [Nested, Package, and Standalone Subprograms](#)
- [Example 5-39](#), ""

Example 5-36 RECORD Type Definition and Variable Declaration

This example defines a `RECORD` type named `DeptRecTyp`, specifying an initial value for each field. Then it declares a variable of that type named `dept_rec` and prints its fields.

 **Live SQL:**

You can view and run this example on Oracle Live SQL at [RECORD Type Definition and Variable Declaration](#)

```
DECLARE
  TYPE DeptRecTyp IS RECORD (
    dept_id    NUMBER(4) NOT NULL := 10,
    dept_name  VARCHAR2(30) NOT NULL := 'Administration',
    mgr_id     NUMBER(6) := 200,
    loc_id     NUMBER(4) := 1700
  );

  dept_rec DeptRecTyp;
BEGIN
  DBMS_OUTPUT.PUT_LINE('dept_id:  ' || dept_rec.dept_id);
  DBMS_OUTPUT.PUT_LINE('dept_name: ' || dept_rec.dept_name);
  DBMS_OUTPUT.PUT_LINE('mgr_id:    ' || dept_rec.mgr_id);
  DBMS_OUTPUT.PUT_LINE('loc_id:    ' || dept_rec.loc_id);
END;
/
```

Result:

```
dept_id:  10
dept_name: Administration
mgr_id:   200
loc_id:   1700
```

Example 5-37 RECORD Type with RECORD Field (Nested Record)

This example defines two `RECORD` types, `name_rec` and `contact`. The type `contact` has a field of type `name_rec`.

 **Live SQL:**

You can view and run this example on Oracle Live SQL at [RECORD Type with RECORD Field \(Nested Record\)](#)

```

DECLARE
  TYPE name_rec IS RECORD (
    first employees.first_name%TYPE,
    last  employees.last_name%TYPE
  );

  TYPE contact IS RECORD (
    name name_rec,           -- nested record
    phone employees.phone_number%TYPE
  );

  friend contact;
BEGIN
  friend.name.first := 'John';
  friend.name.last  := 'Smith';
  friend.phone := '1-650-555-1234';

  DBMS_OUTPUT.PUT_LINE (
    friend.name.first || ' ' ||
    friend.name.last  || ', ' ||
    friend.phone
  );
END;
/

```

Result:

John Smith, 1-650-555-1234

Example 5-38 RECORD Type with Varray Field

This defines a VARRAY type, `full_name`, and a RECORD type, `contact`. The type `contact` has a field of type `full_name`.

 **Live SQL:**

You can view and run this example on Oracle Live SQL at [RECORD Type with Varray Field](#)

```

DECLARE
  TYPE full_name IS VARRAY(2) OF VARCHAR2(20);

  TYPE contact IS RECORD (
    name full_name := full_name('John', 'Smith'), -- varray field
    phone employees.phone_number%TYPE
  );

  friend contact;
BEGIN

```

```

friend.phone := '1-650-555-1234';

DBMS_OUTPUT.PUT_LINE (
  friend.name(1) || ' ' ||
  friend.name(2) || ', ' ||
  friend.phone
);
END;
/

```

Result:

```
John Smith, 1-650-555-1234
```

Example 5-39 Identically Defined Package and Local RECORD Types

In this example, the package `pkg` and the anonymous block define the `RECORD` type `rec_type` identically. The package defines a procedure, `print_rec_type`, which has a `rec_type` parameter. The anonymous block declares the variable `r1` of the package type (`pkg.rec_type`) and the variable `r2` of the local type (`rec_type`). The anonymous block can pass `r1` to `print_rec_type`, but it cannot pass `r2` to `print_rec_type`.

 **Live SQL:**

You can view and run this example on Oracle Live SQL at [Identically Defined Package and Local RECORD Types](#)

```

CREATE OR REPLACE PACKAGE pkg AS
  TYPE rec_type IS RECORD (          -- package RECORD type
    f1 INTEGER,
    f2 VARCHAR2(4)
  );
  PROCEDURE print_rec_type (rec rec_type);
END pkg;
/
CREATE OR REPLACE PACKAGE BODY pkg AS
  PROCEDURE print_rec_type (rec rec_type) IS
  BEGIN
    DBMS_OUTPUT.PUT_LINE(rec.f1);
    DBMS_OUTPUT.PUT_LINE(rec.f2);
  END;
END pkg;
/
DECLARE
  TYPE rec_type IS RECORD (          -- local RECORD type
    f1 INTEGER,
    f2 VARCHAR2(4)
  );
  r1 pkg.rec_type;                  -- package type
  r2 rec_type;                      -- local type

BEGIN
  r1.f1 := 10; r1.f2 := 'abcd';
  r2.f1 := 25; r2.f2 := 'wxyz';

  pkg.print_rec_type(r1); -- succeeds
  pkg.print_rec_type(r2); -- fails

```

```
END;  
/
```

Result:

```
pkg.print_rec_type(r2); -- fails  
*  
ERROR at line 14:  
ORA-06550: line 14, column 3:  
PLS-00306: wrong number or types of arguments in call to 'PRINT_REC_TYPE'
```

5.12.4 Declaring Items using the %ROWTYPE Attribute

The `%ROWTYPE` attribute lets you declare a record variable that represents either a full or partial row of a database table or view.

For the syntax and semantics details, see [%ROWTYPE Attribute](#).

Topics

- [Declaring a Record Variable that Always Represents Full Row](#)
- [Declaring a Record Variable that Can Represent Partial Row](#)
- [%ROWTYPE Attribute and Virtual Columns](#)
- [%ROWTYPE Attribute and Invisible Columns](#)

5.12.4.1 Declaring a Record Variable that Always Represents Full Row

To declare a record variable that always represents a full row of a database table or view, use this syntax:

```
variable_name table_or_view_name%ROWTYPE;
```

For every column of the table or view, the record has a field with the same name and data type.

**See Also:**

["%ROWTYPE Attribute"](#) for more information about `%ROWTYPE`

Example 5-40 %ROWTYPE Variable Represents Full Database Table Row

This example declares a record variable that represents a row of the table `departments`, assigns values to its fields, and prints them. Compare this example to [Example 5-36](#).

**Live SQL:**

You can view and run this example on Oracle Live SQL at [%ROWTYPE Variable Represents Full Database Table Row](#)

```

DECLARE
    dept_rec departments%ROWTYPE;
BEGIN
    -- Assign values to fields:

    dept_rec.department_id := 10;
    dept_rec.department_name := 'Administration';
    dept_rec.manager_id := 200;
    dept_rec.location_id := 1700;

    -- Print fields:

    DBMS_OUTPUT.PUT_LINE('dept_id: ' || dept_rec.department_id);
    DBMS_OUTPUT.PUT_LINE('dept_name: ' || dept_rec.department_name);
    DBMS_OUTPUT.PUT_LINE('mgr_id: ' || dept_rec.manager_id);
    DBMS_OUTPUT.PUT_LINE('loc_id: ' || dept_rec.location_id);
END;
/

```

Result:

```

dept_id: 10
dept_name: Administration
mgr_id: 200
loc_id: 1700

```

Example 5-41 %ROWTYPE Variable Does Not Inherit Initial Values or Constraints

This example creates a table with two columns, each with an initial value and a `NOT NULL` constraint. Then it declares a record variable that represents a row of the table and prints its fields, showing that they did not inherit the initial values or `NOT NULL` constraints.

**Live SQL:**

You can view and run this example on Oracle Live SQL at [%ROWTYPE Variable Does Not Inherit Initial Values or Constraints](#)

```

DROP TABLE t1;
CREATE TABLE t1 (
    c1 INTEGER DEFAULT 0 NOT NULL,
    c2 INTEGER DEFAULT 1 NOT NULL
);

DECLARE
    t1_row t1%ROWTYPE;
BEGIN
    DBMS_OUTPUT.PUT('t1.c1 = ');
    DBMS_OUTPUT.PUT_LINE(NVL(TO_CHAR(t1_row.c1), 'NULL'));

    DBMS_OUTPUT.PUT('t1.c2 = '); print(t1_row.c2);
    DBMS_OUTPUT.PUT_LINE(NVL(TO_CHAR(t1_row.c2), 'NULL'));
END;
/

```

Result:

```
t1.c1 = NULL
t1.c2 = NULL
```

5.12.4.2 Declaring a Record Variable that Can Represent Partial Row

To declare a record variable that can represent a partial row of a database table or view, use this syntax:

```
variable_name cursor%ROWTYPE;
```

A cursor is associated with a query. For every column that the query selects, the record variable must have a corresponding, type-compatible field. If the query selects every column of the table or view, then the variable represents a full row; otherwise, the variable represents a partial row. The cursor must be either an explicit cursor or a strong cursor variable.

See Also:

- ["FETCH Statement"](#) for complete syntax
- ["Cursors Overview"](#) for information about cursors
- ["Explicit Cursors"](#) for information about explicit cursors
- ["Cursor Variables"](#) for information about cursor variables
- *Oracle Database SQL Language Reference* for information about joins

Example 5-42 %ROWTYPE Variable Represents Partial Database Table Row

This example defines an explicit cursor whose query selects only the columns `first_name`, `last_name`, and `phone_number` from the `employees` table in the sample schema `HR`. Then the example declares a record variable that has a field for each column that the cursor selects. The variable represents a partial row of `employees`. Compare this example to [Example 5-37](#).

Live SQL:

You can view and run this example on Oracle Live SQL at [%ROWTYPE Variable Represents Partial Database Table Row](#)

```
DECLARE
  CURSOR c IS
    SELECT first_name, last_name, phone_number
    FROM employees;

  friend c%ROWTYPE;
BEGIN
  friend.first_name := 'John';
  friend.last_name  := 'Smith';
  friend.phone_number := '1-650-555-1234';

  DBMS_OUTPUT.PUT_LINE (
    friend.first_name || ' ' ||
```



```

        friend.last_name || ', ' ||
        friend.phone_number
    );
END;
/

```

Result:

John Smith, 1-650-555-1234

Example 5-43 %ROWTYPE Variable Represents Join Row

This example defines an explicit cursor whose query is a join and then declares a record variable that has a field for each column that the cursor selects.

Live SQL:

You can view and run this example on Oracle Live SQL at [%ROWTYPE Variable Represents Join Row](#)

```

DECLARE
    CURSOR c2 IS
        SELECT employee_id, email, employees.manager_id, location_id
        FROM employees, departments
        WHERE employees.department_id = departments.department_id;

    join_rec c2%ROWTYPE; -- includes columns from two tables

BEGIN
    NULL;
END;
/

```

5.12.4.3 %ROWTYPE Attribute and Virtual Columns

If you use the %ROWTYPE attribute to define a record variable that represents a full row of a table that has a virtual column, then you cannot insert that record into the table. Instead, you must insert the individual record fields into the table, excluding the virtual column.

Example 5-44 Inserting %ROWTYPE Record into Table (Wrong)

This example creates a record variable that represents a full row of a table that has a virtual column, populates the record, and inserts the record into the table, causing ORA-54013.

```

DROP TABLE plch_departure;

CREATE TABLE plch_departure (
    destination    VARCHAR2(100),
    departure_time DATE,
    delay          NUMBER(10),
    expected       GENERATED ALWAYS AS (departure_time + delay/24/60/60)
);

DECLARE

```

```

dep_rec plch_departure%ROWTYPE;
BEGIN
  dep_rec.destination := 'X';
  dep_rec.departure_time := SYSDATE;
  dep_rec.delay := 1500;

  INSERT INTO plch_departure VALUES dep_rec;
END;
/

```

Result:

```

DECLARE
*
ERROR at line 1:
ORA-54013: INSERT operation disallowed on virtual columns
ORA-06512: at line 8

```

Example 5-45 Inserting %ROWTYPE Record into Table (Right)

This solves the problem in [Example 5-44](#) by inserting the individual record fields into the table, excluding the virtual column.

```

DECLARE
  dep_rec plch_departure%rowtype;
BEGIN
  dep_rec.destination := 'X';
  dep_rec.departure_time := SYSDATE;
  dep_rec.delay := 1500;

  INSERT INTO plch_departure (destination, departure_time, delay)
  VALUES (dep_rec.destination, dep_rec.departure_time, dep_rec.delay);
end;
/

```

Result:

```

PL/SQL procedure successfully completed.

```

5.12.4.4 %ROWTYPE Attribute and Invisible Columns

Suppose that you use the `%ROWTYPE` attribute to define a record variable that represents a row of a table that has an invisible column, and then you make the invisible column visible.

If you define the record variable with a cursor, as in "[Declaring a Record Variable that Can Represent Partial Row](#)", then making the invisible column visible does not change the structure of the record variable.

However, if you define the record variable as in "[Declaring a Record Variable that Always Represents Full Row](#)" and use a `SELECT * INTO` statement to assign values to the record, then making the invisible column visible does change the structure of the record—see [Example 5-46](#).

See Also:

Oracle Database SQL Language Reference for general information about invisible columns

Example 5-46 %ROWTYPE Affected by Making Invisible Column Visible

```

CREATE TABLE t (a INT, b INT, c INT INVISIBLE);
INSERT INTO t (a, b, c) VALUES (1, 2, 3);
COMMIT;

DECLARE
  t_rec t%ROWTYPE; -- t_rec has fields a and b, but not c
BEGIN
  SELECT * INTO t_rec FROM t WHERE ROWNUM < 2; -- t_rec(a)=1, t_rec(b)=2
  DBMS_OUTPUT.PUT_LINE('c = ' || t_rec.c);
END;
/

```

Result:

```

DBMS_OUTPUT.PUT_LINE('c = ' || t_rec.c);
*
ERROR at line 5:
ORA-06550: line 5, column 40:
PLS-00302: component 'C' must be declared
ORA-06550: line 5, column 3:
PL/SQL: Statement ignored

```

Make invisible column visible:

```
ALTER TABLE t MODIFY (c VISIBLE);
```

Result:

Table altered.

Repeat preceding anonymous block:

```

DECLARE
  t_rec t%ROWTYPE; -- t_rec has fields a, b, and c
BEGIN
  SELECT * INTO t_rec FROM t WHERE ROWNUM < 2; -- t_rec(a)=1, t_rec(b)=2,
  -- t_rec(c)=3
  DBMS_OUTPUT.PUT_LINE('c = ' || t_rec.c);
END;
/

```

Result:**c = 3**

PL/SQL procedure successfully completed.

5.13 Assigning Values to Record Variables

A *record variable* means either a record variable or a record component of a composite variable.

To any record variable, you can assign a value to each field individually.

You can assign values using qualified expressions (see [Example 5-8](#)).

In some cases, you can assign the value of one record variable to another record variable.

If a record variable represents a full or partial row of a database table or view, you can assign the represented row to the record variable.

Topics

- [Assigning One Record Variable to Another](#)
- [Assigning Full or Partial Rows to Record Variables](#)
- [Assigning NULL to a Record Variable](#)

5.13.1 Assigning One Record Variable to Another

You can assign the value of one record variable to another record variable only in these cases:

- The two variables have the same `RECORD` type.
- The target variable is declared with a `RECORD` type, the source variable is declared with `%ROWTYPE`, their fields match in number and order, and corresponding fields have the same data type.

For record components of composite variables, the types of the composite variables need not match.

Example 5-47 Assigning Record to Another Record of Same RECORD Type

In this example, `name1` and `name2` have the same `RECORD` type, so you can assign the value of `name1` to `name2`.

```
DECLARE
  TYPE name_rec IS RECORD (
    first employees.first_name%TYPE DEFAULT 'John',
    last  employees.last_name%TYPE  DEFAULT 'Doe'
  );

  name1 name_rec;
  name2 name_rec;

BEGIN
  name1.first := 'Jane'; name1.last := 'Smith';
  DBMS_OUTPUT.PUT_LINE('name1: ' || name1.first || ' ' || name1.last);
  name2 := name1;
  DBMS_OUTPUT.PUT_LINE('name2: ' || name2.first || ' ' || name2.last);
END;
/
```

Result:

```
name1: Jane Smith
name2: Jane Smith
```

Example 5-48 Assigning %ROWTYPE Record to RECORD Type Record

In this example, the target variable is declared with a `RECORD` type, the source variable is declared with `%ROWTYPE`, their fields match in number and order, and corresponding fields have the same data type.

```

DECLARE
  TYPE name_rec IS RECORD (
    first employees.first_name%TYPE DEFAULT 'John',
    last  employees.last_name%TYPE  DEFAULT 'Doe'
  );

  CURSOR c IS
    SELECT first_name, last_name
    FROM employees;

  target name_rec;
  source c%ROWTYPE;

BEGIN
  source.first_name := 'Jane'; source.last_name := 'Smith';

  DBMS_OUTPUT.PUT_LINE (
    'source: ' || source.first_name || ' ' || source.last_name
  );

  target := source;

  DBMS_OUTPUT.PUT_LINE (
    'target: ' || target.first || ' ' || target.last
  );
END;
/

```

Result:

```

source: Jane Smith
target: Jane Smith

```

Example 5-49 Assigning Nested Record to Another Record of Same RECORD Type

This example assigns the value of one nested record to another nested record. The nested records have the same `RECORD` type, but the records in which they are nested do not.

```

DECLARE
  TYPE name_rec IS RECORD (
    first employees.first_name%TYPE,
    last  employees.last_name%TYPE
  );

  TYPE phone_rec IS RECORD (
    name name_rec,           -- nested record
    phone employees.phone_number%TYPE
  );

  TYPE email_rec IS RECORD (
    name name_rec,           -- nested record
    email employees.email%TYPE
  );

  phone_contact phone_rec;
  email_contact email_rec;

BEGIN
  phone_contact.name.first := 'John';

```

```

phone_contact.name.last := 'Smith';
phone_contact.phone := '1-650-555-1234';

email_contact.name := phone_contact.name;
email_contact.email := (
    email_contact.name.first || '.' ||
    email_contact.name.last  || '@' ||
    'example.com'
);

DBMS_OUTPUT.PUT_LINE (email_contact.email);
END;
/

```

Result:

```
John.Smith@example.com
```

5.13.2 Assigning Full or Partial Rows to Record Variables

If a record variable represents a full or partial row of a database table or view, you can assign the represented row to the record variable.

Topics

- [Using SELECT INTO to Assign a Row to a Record Variable](#)
- [Using FETCH to Assign a Row to a Record Variable](#)
- [Using SQL Statements to Return Rows in PL/SQL Record Variables](#)

5.13.2.1 Using SELECT INTO to Assign a Row to a Record Variable

The syntax of a simple `SELECT INTO` statement is:

```
SELECT select_list INTO record_variable_name FROM table_or_view_name;
```

For each column in *select_list*, the record variable must have a corresponding, type-compatible field. The columns in *select_list* must appear in the same order as the record fields.



See Also:

"[SELECT INTO Statement](#)" for complete syntax

Example 5-50 SELECT INTO Assigns Values to Record Variable

In this example, the record variable `rec1` represents a partial row of the `employees` table—the columns `last_name` and `employee_id`. The `SELECT INTO` statement selects from `employees` the row for which `job_id` is `'AD_PRES'` and assigns the values of the columns `last_name` and `employee_id` in that row to the corresponding fields of `rec1`.

```

DECLARE
    TYPE RecordTyp IS RECORD (
        last employees.last_name%TYPE,
        id   employees.employee_id%TYPE
    );

```

```

);
rec1 RecordTyp;
BEGIN
  SELECT last_name, employee_id INTO rec1
  FROM employees
  WHERE job_id = 'AD_PRES';

  DBMS_OUTPUT.PUT_LINE ('Employee #' || rec1.id || ' = ' || rec1.last);
END;
/

```

Result:

Employee #100 = King

5.13.2.2 Using FETCH to Assign a Row to a Record Variable

The syntax of a simple `FETCH` statement is:

```
FETCH cursor INTO record_variable_name;
```

A cursor is associated with a query. For every column that the query selects, the record variable must have a corresponding, type-compatible field. The cursor must be either an explicit cursor or a strong cursor variable.

See Also:

- ["FETCH Statement"](#) for complete syntax
- ["Cursors Overview"](#) for information about all cursors
- ["Explicit Cursors"](#) for information about explicit cursors
- ["Cursor Variables"](#) for information about cursor variables

Example 5-51 `FETCH` Assigns Values to Record that Function Returns

In this example, each variable of `RECORD` type `EmpRecTyp` represents a partial row of the `employees` table—the columns `employee_id` and `salary`. Both the cursor and the function return a value of type `EmpRecTyp`. In the function, a `FETCH` statement assigns the values of the columns `employee_id` and `salary` to the corresponding fields of a local variable of type `EmpRecTyp`.

```

DECLARE
  TYPE EmpRecTyp IS RECORD (
    emp_id employees.employee_id%TYPE,
    salary employees.salary%TYPE
  );

  CURSOR desc_salary RETURN EmpRecTyp IS
    SELECT employee_id, salary
    FROM employees
    ORDER BY salary DESC;

  highest_paid_emp      EmpRecTyp;
  next_highest_paid_emp EmpRecTyp;

```

```

FUNCTION nth_highest_salary (n INTEGER) RETURN EmpRecTyp IS
  emp_rec EmpRecTyp;
BEGIN
  OPEN desc_salary;
  FOR i IN 1..n LOOP
    FETCH desc_salary INTO emp_rec;
  END LOOP;
  CLOSE desc_salary;
  RETURN emp_rec;
END nth_highest_salary;

BEGIN
  highest_paid_emp := nth_highest_salary(1);
  next_highest_paid_emp := nth_highest_salary(2);

  DBMS_OUTPUT.PUT_LINE(
    'Highest Paid: #' ||
    highest_paid_emp.emp_id || ', $' ||
    highest_paid_emp.salary
  );
  DBMS_OUTPUT.PUT_LINE(
    'Next Highest Paid: #' ||
    next_highest_paid_emp.emp_id || ', $' ||
    next_highest_paid_emp.salary
  );
END;
/

```

Result:

```

Highest Paid: #100, $24000
Next Highest Paid: #101, $17000

```

5.13.2.3 Using SQL Statements to Return Rows in PL/SQL Record Variables

The SQL statements `INSERT`, `UPDATE`, and `DELETE` have an optional `RETURNING INTO` clause that can return the affected row in a PL/SQL record variable.

For information about this clause, see "[RETURNING INTO Clause](#)".

Example 5-52 UPDATE Statement Assigns Values to Record Variable

In this example, the `UPDATE` statement updates the salary of an employee and returns the name and new salary of the employee in a record variable.

```

DECLARE
  TYPE EmpRec IS RECORD (
    last_name employees.last_name%TYPE,
    salary employees.salary%TYPE
  );
  emp_info EmpRec;
  old_salary employees.salary%TYPE;
BEGIN
  SELECT salary INTO old_salary
  FROM employees
  WHERE employee_id = 100;

  UPDATE employees
  SET salary = salary * 1.1
  WHERE employee_id = 100
  RETURNING last_name, salary INTO emp_info;

```



```
DBMS_OUTPUT.PUT_LINE (
  'Salary of ' || emp_info.last_name || ' raised from ' ||
  old_salary || ' to ' || emp_info.salary
);
END;
/
```

Result:

Salary of King raised from 24000 to 26400

5.13.3 Assigning NULL to a Record Variable

Assigning the value `NULL` to a record variable assigns the value `NULL` to each of its fields.

This assignment is recursive; that is, if a field is a record, then its fields are also assigned the value `NULL`.

Example 5-53 Assigning NULL to Record Variable

This example prints the fields of a record variable (one of which is a record) before and after assigning `NULL` to it.

```
DECLARE
  TYPE age_rec IS RECORD (
    years INTEGER DEFAULT 35,
    months INTEGER DEFAULT 6
  );

  TYPE name_rec IS RECORD (
    first employees.first_name%TYPE DEFAULT 'John',
    last  employees.last_name%TYPE  DEFAULT 'Doe',
    age   age_rec
  );

  name name_rec;

PROCEDURE print_name AS
BEGIN
  DBMS_OUTPUT.PUT(NVL(name.first, 'NULL') || ' ');
  DBMS_OUTPUT.PUT(NVL(name.last, 'NULL') || ', ');
  DBMS_OUTPUT.PUT(NVL(TO_CHAR(name.age.years), 'NULL') || ' yrs ');
  DBMS_OUTPUT.PUT_LINE(NVL(TO_CHAR(name.age.months), 'NULL') || ' mos');
END;

BEGIN
  print_name;
  name := NULL;
  print_name;
END;
/
```

Result:

John Doe, 35 yrs 6 mos
NULL NULL, NULL yrs NULL mos

5.14 Record Comparisons

Records cannot be tested natively for nullity, equality, or inequality.

These `BOOLEAN` expressions are illegal:

- `My_Record IS NULL`
- `My_Record_1 = My_Record_2`
- `My_Record_1 > My_Record_2`

You must write your own functions to implement such tests. For information about writing functions, see [PL/SQL Subprograms](#).

5.15 Inserting Records into Tables

The PL/SQL extension to the SQL `INSERT` statement lets you insert a record into a table.

The record must represent a row of the table. For more information, see "[INSERT Statement Extension](#)". For restrictions on inserting records into tables, see "[Restrictions on Record Inserts and Updates](#)".

To efficiently insert a collection of records into a table, put the `INSERT` statement inside a `FORALL` statement. For information about the `FORALL` statement, see "[FORALL Statement](#)".

Example 5-54 Initializing Table by Inserting Record of Default Values

This example creates the table `schedule` and initializes it by putting default values in a record and inserting the record into the table for each week. (The `COLUMN` formatting commands are from `SQL*Plus`.)

```
DROP TABLE schedule;
CREATE TABLE schedule (
  week NUMBER,
  Mon VARCHAR2(10),
  Tue VARCHAR2(10),
  Wed VARCHAR2(10),
  Thu VARCHAR2(10),
  Fri VARCHAR2(10),
  Sat VARCHAR2(10),
  Sun VARCHAR2(10)
);

DECLARE
  default_week schedule%ROWTYPE;
  i NUMBER;
BEGIN
  default_week.Mon := '0800-1700';
  default_week.Tue := '0800-1700';
  default_week.Wed := '0800-1700';
  default_week.Thu := '0800-1700';
  default_week.Fri := '0800-1700';
  default_week.Sat := 'Day Off';
  default_week.Sun := 'Day Off';

  FOR i IN 1..6 LOOP
    default_week.week := i;
```

```

        INSERT INTO schedule VALUES default_week;
    END LOOP;
END;
/

```

```

COLUMN week FORMAT 99
COLUMN Mon  FORMAT A9
COLUMN Tue  FORMAT A9
COLUMN Wed  FORMAT A9
COLUMN Thu  FORMAT A9
COLUMN Fri  FORMAT A9
COLUMN Sat  FORMAT A9
COLUMN Sun  FORMAT A9

```

```
SELECT * FROM schedule;
```

Result:

WEEK	MON	TUE	WED	THU	FRI	SAT	SUN
1	0800-1700	0800-1700	0800-1700	0800-1700	0800-1700	Day Off	Day Off
2	0800-1700	0800-1700	0800-1700	0800-1700	0800-1700	Day Off	Day Off
3	0800-1700	0800-1700	0800-1700	0800-1700	0800-1700	Day Off	Day Off
4	0800-1700	0800-1700	0800-1700	0800-1700	0800-1700	Day Off	Day Off
5	0800-1700	0800-1700	0800-1700	0800-1700	0800-1700	Day Off	Day Off
6	0800-1700	0800-1700	0800-1700	0800-1700	0800-1700	Day Off	Day Off

5.16 Updating Rows with Records

The PL/SQL extension to the SQL `UPDATE` statement lets you update one or more table rows with a record.

The record must represent a row of the table. For more information, see "[UPDATE Statement Extensions](#)".

For restrictions on updating table rows with a record, see "[Restrictions on Record Inserts and Updates](#)".

To efficiently update a set of rows with a collection of records, put the `UPDATE` statement inside a `FORALL` statement. For information about the `FORALL` statement, see "[FORALL Statement](#)".

Example 5-55 Updating Rows with Record

This example updates the first three weeks of the table `schedule` (defined in [Example 5-54](#)) by putting the new values in a record and updating the first three rows of the table with that record.

```

DECLARE
    default_week  schedule%ROWTYPE;
BEGIN
    default_week.Mon := 'Day Off';
    default_week.Tue := '0900-1800';
    default_week.Wed := '0900-1800';
    default_week.Thu := '0900-1800';
    default_week.Fri := '0900-1800';
    default_week.Sat := '0900-1800';
    default_week.Sun := 'Day Off';

```

```

FOR i IN 1..3 LOOP
    default_week.week := i;

    UPDATE schedule
    SET ROW = default_week
    WHERE week = i;
END LOOP;
END;
/

SELECT * FROM schedule;

```

Result:

WEEK	MON	TUE	WED	THU	FRI	SAT	SUN
1	Day Off	0900-1800	0900-1800	0900-1800	0900-1800	0900-1800	Day Off
2	Day Off	0900-1800	0900-1800	0900-1800	0900-1800	0900-1800	Day Off
3	Day Off	0900-1800	0900-1800	0900-1800	0900-1800	0900-1800	Day Off
4	0800-1700	0800-1700	0800-1700	0800-1700	0800-1700	Day Off	Day Off
5	0800-1700	0800-1700	0800-1700	0800-1700	0800-1700	Day Off	Day Off
6	0800-1700	0800-1700	0800-1700	0800-1700	0800-1700	Day Off	Day Off

5.17 Restrictions on Record Inserts and Updates

These restrictions apply to record inserts and updates:

- Record variables are allowed only in these places:
 - On the right side of the `SET` clause in an `UPDATE` statement
 - In the `VALUES` clause of an `INSERT` statement
 - In the `INTO` subclause of a `RETURNING` clause

Record variables are not allowed in a `SELECT` list, `WHERE` clause, `GROUP BY` clause, or `ORDER BY` clause.

- The keyword `ROW` is allowed only on the left side of a `SET` clause. Also, you cannot use `ROW` with a subquery.
- In an `UPDATE` statement, only one `SET` clause is allowed if `ROW` is used.
- If the `VALUES` clause of an `INSERT` statement contains a record variable, no other variable or value is allowed in the clause.
- If the `INTO` subclause of a `RETURNING` clause contains a record variable, no other variable or value is allowed in the subclause.
- These are not supported:
 - Nested `RECORD` types
 - Functions that return a `RECORD` type
 - Record inserts and updates using the `EXECUTE IMMEDIATE` statement.

6

PL/SQL Static SQL

Static SQL is a PL/SQL feature that allows SQL syntax directly in a PL/SQL statement.

This chapter describes static SQL and explains how to use it.

Topics

- [Description of Static SQL](#)
- [Cursors Overview](#)
- [Processing Query Result Sets](#)
- [Cursor Variables](#)
- [CURSOR Expressions](#)
- [Transaction Processing and Control](#)
- [Autonomous Transactions](#)



See Also:

["Resolution of Names in Static SQL Statements"](#)

6.1 Description of Static SQL

Static SQL has the same syntax as SQL, except as noted.

Topics

- [Statements](#)
- [Pseudocolumns](#)

6.1.1 Statements

These are the PL/SQL static SQL statements, which have the same syntax as the corresponding SQL statements, except as noted:

- `SELECT` (this statement is also called a **query**)
For the PL/SQL syntax, see "[SELECT INTO Statement](#)".
- Data manipulation language (DML) statements:
 - `INSERT`
For the PL/SQL syntax, see "[INSERT Statement Extension](#)".
 - `UPDATE`

For the PL/SQL syntax, see "[UPDATE Statement Extensions](#)".

- DELETE

For the PL/SQL syntax, see "[DELETE Statement Extension](#)".

- MERGE (for syntax, see *Oracle Database SQL Language Reference*)

 **Note:**

Oracle Database SQL Language Reference defines DML differently.

- Transaction control language (TCL) statements:
 - COMMIT (for syntax, see *Oracle Database SQL Language Reference*)
 - ROLLBACK (for syntax, see *Oracle Database SQL Language Reference*)
 - SAVEPOINT (for syntax, see *Oracle Database SQL Language Reference*)
 - SET TRANSACTION (for syntax, see *Oracle Database SQL Language Reference*)
- LOCK TABLE (for syntax, see *Oracle Database SQL Language Reference*)

A PL/SQL static SQL statement can have a PL/SQL identifier wherever its SQL counterpart can have a placeholder for a bind variable. The PL/SQL identifier must identify either a variable or a formal parameter.

To use PL/SQL identifiers for table names, column names, and so on, use the `EXECUTE IMMEDIATE` statement, explained in "[Native Dynamic SQL](#)"

 **Note:**

After PL/SQL code runs a DML statement, the values of some variables are undefined. For example:

- After a `FETCH` or `SELECT` statement raises an exception, the values of the define variables after that statement are undefined.
- After a DML statement that affects zero rows, the values of the `OUT` bind variables are undefined, unless the DML statement is a `BULK` or multiple-row operation.

Example 6-1 Static SQL Statements

In this example, a PL/SQL anonymous block declares three PL/SQL variables and uses them in the static SQL statements `INSERT`, `UPDATE`, `DELETE`. The block also uses the static SQL statement `COMMIT`.

```
DROP TABLE employees_temp;
CREATE TABLE employees_temp AS
  SELECT employee_id, first_name, last_name
  FROM employees;

DECLARE
  emp_id          employees_temp.employee_id%TYPE := 299;
  emp_first_name  employees_temp.first_name%TYPE  := 'Bob';
```

```
emp_last_name employees_temp.last_name%TYPE := 'Henry';
BEGIN
  INSERT INTO employees_temp (employee_id, first_name, last_name)
  VALUES (emp_id, emp_first_name, emp_last_name);

  UPDATE employees_temp
  SET first_name = 'Robert'
  WHERE employee_id = emp_id;

  DELETE FROM employees_temp
  WHERE employee_id = emp_id
  RETURNING first_name, last_name
  INTO emp_first_name, emp_last_name;

  COMMIT;
  DBMS_OUTPUT.PUT_LINE (emp_first_name || ' ' || emp_last_name);
END;
/
```

Result:

Robert Henry

6.1.2 Pseudocolumns

A pseudocolumn behaves like a table column, but it is not stored in the table.

For general information about pseudocolumns, including restrictions, see *Oracle Database SQL Language Reference*.

Static SQL includes these SQL pseudocolumns:

- CURRVAL and NEXTVAL, described in "[CURRVAL and NEXTVAL in PL/SQL](#)".
- LEVEL, described in *Oracle Database SQL Language Reference*
- OBJECT_VALUE, described in *Oracle Database SQL Language Reference*

See Also:

"[OBJECT_VALUE Pseudocolumn](#)" for information about using OBJECT_VALUE in triggers

- ROWID, described in *Oracle Database SQL Language Reference*

See Also:

"[Simulating CURRENT OF Clause with ROWID Pseudocolumn](#)"

- ROWNUM, described in *Oracle Database SQL Language Reference*

6.1.2.1 CURRVAL and NEXTVAL in PL/SQL

After a sequence is created, you can access its values in SQL statements with the `CURRVAL` pseudocolumn, which returns the current value of the sequence, or the `NEXTVAL` pseudocolumn, which increments the sequence and returns the new value.

To reference these pseudocolumns, use dot notation—for example, `sequence_name.CURRVAL`.

 **Note:**

Each time you reference `sequence_name.NEXTVAL`, the sequence is incremented immediately and permanently, whether you commit or roll back the transaction.

You can use `sequence_name.CURRVAL` and `sequence_name.NEXTVAL` in a PL/SQL expression wherever you can use a `NUMBER` expression. However:

- Using `sequence_name.CURRVAL` or `sequence_name.NEXTVAL` to provide a default value for an ADT method parameter causes a compilation error.
- PL/SQL evaluates every occurrence of `sequence_name.CURRVAL` and `sequence_name.NEXTVAL` (unlike SQL, which evaluates a sequence expression for every row in which it appears).

 **See Also:**

- *Oracle Database SQL Language Reference* for general information about sequences
- *Oracle Database SQL Language Reference* for `CURRVAL` and `NEXTVAL` complete syntax

Example 6-2 CURRVAL and NEXTVAL Pseudocolumns

This example generates a sequence number for the sequence `HR.EMPLOYEES_SEQ` and refers to that number in multiple statements.

```
DROP TABLE employees_temp;
CREATE TABLE employees_temp AS
  SELECT employee_id, first_name, last_name
  FROM employees;

DROP TABLE employees_temp2;
CREATE TABLE employees_temp2 AS
  SELECT employee_id, first_name, last_name
  FROM employees;

DECLARE
  seq_value NUMBER;
BEGIN
```



```
-- Generate initial sequence number

seq_value := employees_seq.NEXTVAL;

-- Print initial sequence number:

DBMS_OUTPUT.PUT_LINE (
  'Initial sequence value: ' || TO_CHAR(seq_value)
);

-- Use NEXTVAL to create unique number when inserting data:

INSERT INTO employees_temp (employee_id, first_name, last_name)
VALUES (employees_seq.NEXTVAL, 'Lynette', 'Smith');

-- Use CURRVAL to store same value somewhere else:

INSERT INTO employees_temp2 VALUES (employees_seq.CURRVAL,
                                     'Morgan', 'Smith');

/* Because NEXTVAL values might be referenced
   by different users and applications,
   and some NEXTVAL values might not be stored in database,
   there might be gaps in sequence. */

-- Use CURRVAL to specify record to delete:

seq_value := employees_seq.CURRVAL;

DELETE FROM employees_temp2
WHERE employee_id = seq_value;

-- Update employee_id with NEXTVAL for specified record:

UPDATE employees_temp
SET employee_id = employees_seq.NEXTVAL
WHERE first_name = 'Lynette'
AND last_name = 'Smith';

-- Display final value of CURRVAL:

seq_value := employees_seq.CURRVAL;

DBMS_OUTPUT.PUT_LINE (
  'Ending sequence value: ' || TO_CHAR(seq_value)
);
END;
/
```

6.2 Cursors Overview

A **cursor** is a pointer to a private SQL area that stores information about processing a specific `SELECT` or `DML` statement.

 **Note:**

The cursors that this topic explains are session cursors. A **session cursor** lives in session memory until the session ends, when it ceases to exist.

A cursor that is constructed and managed by PL/SQL is an **implicit cursor**. A cursor that you construct and manage is an **explicit cursor**.

You can get information about any session cursor from its attributes (which you can reference in procedural statements, but not in SQL statements).

To list the session cursors that each user session currently has opened and parsed, query the dynamic performance view `V$OPEN_CURSOR`.

The number of cursors that a session can have open simultaneously is determined by:

- The amount of memory available to the session
- The value of the initialization parameter `OPEN_CURSORS`

 **Note:**

Generally, PL/SQL parses an explicit cursor only the first time the session opens it and parses a SQL statement (creating an implicit cursor) only the first time the statement runs.

All parsed SQL statements are cached. A SQL statement is reparsed only if it is aged out of the cache by a new SQL statement. Although you must close an explicit cursor before you can reopen it, PL/SQL need not reparse the associated query. If you close and immediately reopen an explicit cursor, PL/SQL does not reparse the associated query.

Topics

- [Implicit Cursors](#)
- [Explicit Cursors](#)

 **See Also:**

- *Oracle Database Reference* for information about the dynamic performance view `V$OPEN_CURSOR`
- *Oracle Database Reference* for information about the initialization parameter `OPEN_CURSORS`

6.2.1 Implicit Cursors

An **implicit cursor** is a session cursor that is constructed and managed by PL/SQL. PL/SQL opens an implicit cursor every time you run a `SELECT` or DML statement. You cannot control an implicit cursor, but you can get information from its attributes.

The syntax of an implicit cursor attribute value is `SQLAttribute` (therefore, an implicit cursor is also called a **SQL cursor**). `SQLAttribute` always refers to the most recently run `SELECT` or DML statement. If no such statement has run, the value of `SQLAttribute` is `NULL`.

An implicit cursor closes after its associated statement runs; however, its attribute values remain available until another `SELECT` or DML statement runs.

The most recently run `SELECT` or DML statement might be in a different scope. To save an attribute value for later use, assign it to a local variable immediately. Otherwise, other operations, such as subprogram invocations, might change the value of the attribute before you can test it.

The implicit cursor attributes are:

- [SQL%ISOPEN Attribute: Is the Cursor Open?](#)
- [SQL%FOUND Attribute: Were Any Rows Affected?](#)
- [SQL%NOTFOUND Attribute: Were No Rows Affected?](#)
- [SQL%ROWCOUNT Attribute: How Many Rows Were Affected?](#)
- `SQL%BULK_ROWCOUNT` (see ["Getting Number of Rows Affected by FORALL Statement"](#))
- `SQL%BULK_EXCEPTIONS` (see ["Handling FORALL Exceptions After FORALL Statement Completes"](#))



See Also:

["Implicit Cursor Attribute"](#) for complete syntax and semantics

6.2.1.1 SQL%ISOPEN Attribute: Is the Cursor Open?

`SQL%ISOPEN` always returns `FALSE`, because an implicit cursor always closes after its associated statement runs.

6.2.1.2 SQL%FOUND Attribute: Were Any Rows Affected?

`SQL%FOUND` returns:

- `NULL` if no `SELECT` or DML statement has run
- `TRUE` if a `SELECT` statement returned one or more rows or a DML statement affected one or more rows
- `FALSE` otherwise

[Example 6-3](#) uses `SQL%FOUND` to determine if a `DELETE` statement affected any rows.

Example 6-3 SQL%FOUND Implicit Cursor Attribute

```

DROP TABLE dept_temp;
CREATE TABLE dept_temp AS
  SELECT * FROM departments;

CREATE OR REPLACE PROCEDURE p (
  dept_no NUMBER
) AUTHID CURRENT_USER AS
BEGIN
  DELETE FROM dept_temp
  WHERE department_id = dept_no;

  IF SQL%FOUND THEN
    DBMS_OUTPUT.PUT_LINE (
      'Delete succeeded for department number ' || dept_no
    );
  ELSE
    DBMS_OUTPUT.PUT_LINE ('No department number ' || dept_no);
  END IF;
END;
/
BEGIN
  p(270);
  p(400);
END;
/

```

Result:

```

Delete succeeded for department number 270
No department number 400

```

6.2.1.3 SQL%NOTFOUND Attribute: Were No Rows Affected?

SQL%NOTFOUND (the logical opposite of SQL%FOUND) returns:

- NULL if no SELECT or DML statement has run
- FALSE if a SELECT statement returned one or more rows or a DML statement affected one or more rows
- TRUE otherwise

The SQL%NOTFOUND attribute is not useful with the PL/SQL SELECT INTO statement, because:

- If the SELECT INTO statement returns no rows, PL/SQL raises the predefined exception NO_DATA_FOUND immediately, before you can check SQL%NOTFOUND.
- A SELECT INTO statement that invokes a SQL aggregate function always returns a value (possibly NULL). After such a statement, the SQL%NOTFOUND attribute is always FALSE, so checking it is unnecessary.

6.2.1.4 SQL%ROWCOUNT Attribute: How Many Rows Were Affected?

SQL%ROWCOUNT returns:

- NULL if no SELECT or DML statement has run

- Otherwise, the number of rows returned by a `SELECT` statement or affected by a DML statement (an `INTEGER`)

**Note:**

If a server is Oracle Database 12c or later and its client is Oracle Database 11g release 2 or earlier (or the reverse), then the maximum number that `SQL%ROWCOUNT` returns is 4,294,967,295.

Example 6-4 uses `SQL%ROWCOUNT` to determine the number of rows that were deleted.

If a `SELECT INTO` statement without a `BULK COLLECT` clause returns multiple rows, PL/SQL raises the predefined exception `TOO_MANY_ROWS` and `SQL%ROWCOUNT` returns 1, not the actual number of rows that satisfy the query.

The value of `SQL%ROWCOUNT` attribute is unrelated to the state of a transaction. Therefore:

- When a transaction rolls back to a savepoint, the value of `SQL%ROWCOUNT` is not restored to the value it had before the savepoint.
- When an autonomous transaction ends, `SQL%ROWCOUNT` is not restored to the original value in the parent transaction.

Example 6-4 SQL%ROWCOUNT Implicit Cursor Attribute

```
DROP TABLE employees_temp;
CREATE TABLE employees_temp AS
  SELECT * FROM employees;

DECLARE
  mgr_no NUMBER(6) := 122;
BEGIN
  DELETE FROM employees_temp WHERE manager_id = mgr_no;
  DBMS_OUTPUT.PUT_LINE
    ('Number of employees deleted: ' || TO_CHAR(SQL%ROWCOUNT));
END;
/
```

Result:

```
Number of employees deleted: 8
```

6.2.2 Explicit Cursors

An **explicit cursor** is a session cursor that you construct and manage. You must declare and define an explicit cursor, giving it a name and associating it with a query (typically, the query returns multiple rows). Then you can process the query result set in either of these ways:

- Open the explicit cursor (with the `OPEN` statement), fetch rows from the result set (with the `FETCH` statement), and close the explicit cursor (with the `CLOSE` statement).
- Use the explicit cursor in a cursor `FOR LOOP` statement (see "[Processing Query Result Sets With Cursor FOR LOOP Statements](#)").

You cannot assign a value to an explicit cursor, use it in an expression, or use it as a formal subprogram parameter or host variable. You *can* do those things with a cursor variable (see "[Cursor Variables](#)").

Unlike an implicit cursor, you can reference an explicit cursor or cursor variable by its name. Therefore, an explicit cursor or cursor variable is called a **named cursor**.

Topics

- [Declaring and Defining Explicit Cursors](#)
- [Opening and Closing Explicit Cursors](#)
- [Fetching Data with Explicit Cursors](#)
- [Variables in Explicit Cursor Queries](#)
- [When Explicit Cursor Queries Need Column Aliases](#)
- [Explicit Cursors that Accept Parameters](#)
- [Explicit Cursor Attributes](#)

6.2.2.1 Declaring and Defining Explicit Cursors

You can either declare an explicit cursor first and then define it later in the same block, subprogram, or package, or declare and define it at the same time.

An **explicit cursor declaration**, which only declares a cursor, has this syntax:

```
CURSOR cursor_name [ parameter_list ] RETURN return_type;
```

An **explicit cursor definition** has this syntax:

```
CURSOR cursor_name [ parameter_list ] [ RETURN return_type ]  
  IS select_statement;
```

If you declared the cursor earlier, then the explicit cursor definition defines it; otherwise, it both declares and defines it.

[Example 6-5](#) declares and defines three explicit cursors.



See Also:

- ["Explicit Cursor Declaration and Definition"](#) for the complete syntax and semantics of explicit cursor declaration and definition
- ["Explicit Cursors that Accept Parameters"](#)

Example 6-5 Explicit Cursor Declaration and Definition

```
DECLARE  
  CURSOR c1 RETURN departments%ROWTYPE;      -- Declare c1  
  
  CURSOR c2 IS                                -- Declare and define c2  
    SELECT employee_id, job_id, salary FROM employees  
    WHERE salary > 2000;  
  
  CURSOR c1 RETURN departments%ROWTYPE IS    -- Define c1,  
    SELECT * FROM departments                -- repeating return type  
    WHERE department_id = 110;  
  
  CURSOR c3 RETURN locations%ROWTYPE;        -- Declare c3
```

```

CURSOR c3 IS                                -- Define c3,
  SELECT * FROM locations                    -- omitting return type
  WHERE country_id = 'JP';
BEGIN
  NULL;
END;
/

```

6.2.2.2 Opening and Closing Explicit Cursors

After declaring and defining an explicit cursor, you can open it with the `OPEN` statement, which does the following:

1. Allocates database resources to process the query
2. Processes the query; that is:
 - a. Identifies the result set

If the query references variables or cursor parameters, their values affect the result set. For details, see ["Variables in Explicit Cursor Queries"](#) and ["Explicit Cursors that Accept Parameters"](#).
 - b. If the query has a `FOR UPDATE` clause, locks the rows of the result set

For details, see ["SELECT FOR UPDATE and FOR UPDATE Cursors"](#).
3. Positions the cursor before the first row of the result set

You close an open explicit cursor with the `CLOSE` statement, thereby allowing its resources to be reused. After closing a cursor, you cannot fetch records from its result set or reference its attributes. If you try, PL/SQL raises the predefined exception `INVALID_CURSOR`.

You can reopen a closed cursor. You must close an explicit cursor before you try to reopen it. Otherwise, PL/SQL raises the predefined exception `CURSOR_ALREADY_OPEN`.



See Also:

- ["OPEN Statement"](#) for its syntax and semantics
- ["CLOSE Statement"](#) for its syntax and semantics

6.2.2.3 Fetching Data with Explicit Cursors

After opening an explicit cursor, you can fetch the rows of the query result set with the `FETCH` statement. The basic syntax of a `FETCH` statement that returns one row is:

```
FETCH cursor_name INTO into_clause
```

The `into_clause` is either a list of variables or a single record variable. For each column that the query returns, the variable list or record must have a corresponding type-compatible variable or field. The `%TYPE` and `%ROWTYPE` attributes are useful for declaring variables and records for use in `FETCH` statements.

The `FETCH` statement retrieves the current row of the result set, stores the column values of that row into the variables or record, and advances the cursor to the next row.

Typically, you use the `FETCH` statement inside a `LOOP` statement, which you exit when the `FETCH` statement runs out of rows. To detect this exit condition, use the cursor attribute `%NOTFOUND` (described in "[%NOTFOUND Attribute: Has No Row Been Fetched?](#)"). PL/SQL does not raise an exception when a `FETCH` statement returns no rows.

Example 6-6 fetches the result sets of two explicit cursors one row at a time, using `FETCH` and `%NOTFOUND` inside `LOOP` statements. The first `FETCH` statement retrieves column values into variables. The second `FETCH` statement retrieves column values into a record. The variables and record are declared with `%TYPE` and `%ROWTYPE`, respectively.

Example 6-7 fetches the first five rows of a result set into five records, using five `FETCH` statements, each of which fetches into a different record variable. The record variables are declared with `%ROWTYPE`.

See Also:

- "[FETCH Statement](#)" for its complete syntax and semantics
- "[FETCH Statement with BULK COLLECT Clause](#)" for information about `FETCH` statements that return more than one row at a time

Example 6-6 FETCH Statements Inside LOOP Statements

```

DECLARE
  CURSOR c1 IS
    SELECT last_name, job_id FROM employees
    WHERE REGEXP_LIKE (job_id, 'S[HT]_CLERK')
    ORDER BY last_name;

  v_lastname employees.last_name%TYPE; -- variable for last_name
  v_jobid    employees.job_id%TYPE;    -- variable for job_id

  CURSOR c2 IS
    SELECT * FROM employees
    WHERE REGEXP_LIKE (job_id, '[ACADFIMKSA]_M[ANGR]')
    ORDER BY job_id;

  v_employees employees%ROWTYPE; -- record variable for row of table

BEGIN
  OPEN c1;
  LOOP -- Fetches 2 columns into variables
    FETCH c1 INTO v_lastname, v_jobid;
    EXIT WHEN c1%NOTFOUND;
    DBMS_OUTPUT.PUT_LINE( RPAD(v_lastname, 25, ' ') || v_jobid );
  END LOOP;
  CLOSE c1;
  DBMS_OUTPUT.PUT_LINE( '-----' );

  OPEN c2;
  LOOP -- Fetches entire row into the v_employees record
    FETCH c2 INTO v_employees;
    EXIT WHEN c2%NOTFOUND;
    DBMS_OUTPUT.PUT_LINE( RPAD(v_employees.last_name, 25, ' ') ||

```



```

                                v_employees.job_id );
    END LOOP;
    CLOSE c2;
END;
/

```

Result:

```

Atkinson          ST_CLERK
Bell              SH_CLERK
Bissot            ST_CLERK
...
Walsh             SH_CLERK
-----
Higgins           AC_MGR
Greenberg         FI_MGR
Hartstein         MK_MAN
...
Zlotkey           SA_MAN

```

Example 6-7 Fetching Same Explicit Cursor into Different Variables

```

DECLARE
    CURSOR c IS
        SELECT e.job_id, j.job_title
        FROM employees e, jobs j
        WHERE e.job_id = j.job_id AND e.manager_id = 100
        ORDER BY last_name;

    -- Record variables for rows of cursor result set:

    job1 c%ROWTYPE;
    job2 c%ROWTYPE;
    job3 c%ROWTYPE;
    job4 c%ROWTYPE;
    job5 c%ROWTYPE;

BEGIN
    OPEN c;
    FETCH c INTO job1; -- fetches first row
    FETCH c INTO job2; -- fetches second row
    FETCH c INTO job3; -- fetches third row
    FETCH c INTO job4; -- fetches fourth row
    FETCH c INTO job5; -- fetches fifth row
    CLOSE c;

    DBMS_OUTPUT.PUT_LINE(job1.job_title || ' (' || job1.job_id || ')');
    DBMS_OUTPUT.PUT_LINE(job2.job_title || ' (' || job2.job_id || ')');
    DBMS_OUTPUT.PUT_LINE(job3.job_title || ' (' || job3.job_id || ')');
    DBMS_OUTPUT.PUT_LINE(job4.job_title || ' (' || job4.job_id || ')');
    DBMS_OUTPUT.PUT_LINE(job5.job_title || ' (' || job5.job_id || ')');
END;
/

```

Result:

```

Sales Manager (SA_MAN)
Administration Vice President (AD_VP)
Sales Manager (SA_MAN)
Stock Manager (ST_MAN)
Marketing Manager (MK_MAN)

```

PL/SQL procedure successfully completed.

6.2.2.4 Variables in Explicit Cursor Queries

An explicit cursor query can reference any variable in its scope. When you open an explicit cursor, PL/SQL evaluates any variables in the query and uses those values when identifying the result set. Changing the values of the variables later does not change the result set.

In [Example 6-8](#), the explicit cursor query references the variable `factor`. When the cursor opens, `factor` has the value 2. Therefore, `sal_multiple` is always 2 times `sal`, despite that `factor` is incremented after every fetch.

To change the result set, you must close the cursor, change the value of the variable, and then open the cursor again, as in [Example 6-9](#).

Example 6-8 Variable in Explicit Cursor Query—No Result Set Change

```
DECLARE
    sal            employees.salary%TYPE;
    sal_multiple   employees.salary%TYPE;
    factor         INTEGER := 2;

    CURSOR c1 IS
        SELECT salary, salary*factor FROM employees
        WHERE job_id LIKE 'AD_%';

BEGIN
    OPEN c1; -- PL/SQL evaluates factor

    LOOP
        FETCH c1 INTO sal, sal_multiple;
        EXIT WHEN c1%NOTFOUND;
        DBMS_OUTPUT.PUT_LINE('factor = ' || factor);
        DBMS_OUTPUT.PUT_LINE('sal      = ' || sal);
        DBMS_OUTPUT.PUT_LINE('sal_multiple = ' || sal_multiple);
        factor := factor + 1; -- Does not affect sal_multiple
    END LOOP;

    CLOSE c1;
END;
/
```

Result:

```
factor = 2
sal      = 4400
sal_multiple = 8800
factor = 3
sal      = 24000
sal_multiple = 48000
factor = 4
sal      = 17000
sal_multiple = 34000
factor = 5
sal      = 17000
sal_multiple = 34000
```

Example 6-9 Variable in Explicit Cursor Query—Result Set Change

```
DECLARE
  sal          employees.salary%TYPE;
  sal_multiple employees.salary%TYPE;
  factor       INTEGER := 2;

  CURSOR c1 IS
    SELECT salary, salary*factor FROM employees
    WHERE job_id LIKE 'AD_%';

BEGIN
  DBMS_OUTPUT.PUT_LINE('factor = ' || factor);
  OPEN c1; -- PL/SQL evaluates factor
  LOOP
    FETCH c1 INTO sal, sal_multiple;
    EXIT WHEN c1%NOTFOUND;
    DBMS_OUTPUT.PUT_LINE('sal          = ' || sal);
    DBMS_OUTPUT.PUT_LINE('sal_multiple = ' || sal_multiple);
  END LOOP;
  CLOSE c1;

  factor := factor + 1;

  DBMS_OUTPUT.PUT_LINE('factor = ' || factor);
  OPEN c1; -- PL/SQL evaluates factor
  LOOP
    FETCH c1 INTO sal, sal_multiple;
    EXIT WHEN c1%NOTFOUND;
    DBMS_OUTPUT.PUT_LINE('sal          = ' || sal);
    DBMS_OUTPUT.PUT_LINE('sal_multiple = ' || sal_multiple);
  END LOOP;
  CLOSE c1;
END;
/
```

Result:

```
factor = 2
sal          = 4400
sal_multiple = 8800
sal          = 24000
sal_multiple = 48000
sal          = 17000
sal_multiple = 34000
sal          = 17000
sal_multiple = 34000
factor = 3
sal          = 4400
sal_multiple = 13200
sal          = 24000
sal_multiple = 72000
sal          = 17000
sal_multiple = 51000
sal          = 17000
sal_multiple = 51000
```

6.2.2.5 When Explicit Cursor Queries Need Column Aliases

When an explicit cursor query includes a virtual column (an expression), that column must have an alias if either of the following is true:

- You use the cursor to fetch into a record that was declared with %ROWTYPE.
- You want to reference the virtual column in your program.

In [Example 6-10](#), the virtual column in the explicit cursor needs an alias for both of the preceding reasons.



See Also:

[Example 6-21](#)

Example 6-10 Explicit Cursor with Virtual Column that Needs Alias

```

DECLARE
  CURSOR c1 IS
    SELECT employee_id,
           (salary * .05) raise
    FROM employees
    WHERE job_id LIKE '%_MAN'
    ORDER BY employee_id;
  emp_rec c1%ROWTYPE;
BEGIN
  OPEN c1;
  LOOP
    FETCH c1 INTO emp_rec;
    EXIT WHEN c1%NOTFOUND;
    DBMS_OUTPUT.PUT_LINE (
      'Raise for employee #' || emp_rec.employee_id ||
      ' is $' || emp_rec.raise
    );
  END LOOP;
  CLOSE c1;
END;
/

```

Result:

```

Raise for employee #114 is $550
Raise for employee #120 is $400
Raise for employee #121 is $410
Raise for employee #122 is $395
Raise for employee #123 is $325
Raise for employee #124 is $368.445
Raise for employee #145 is $700
Raise for employee #146 is $675
Raise for employee #147 is $600
Raise for employee #148 is $550
Raise for employee #149 is $525
Raise for employee #201 is $650

```

6.2.2.6 Explicit Cursors that Accept Parameters

You can create an explicit cursor that has formal parameters, and then pass different actual parameters to the cursor each time you open it. In the cursor query, you can use a formal cursor parameter anywhere that you can use a constant. Outside the cursor query, you cannot reference formal cursor parameters.

**Tip:**

To avoid confusion, use different names for formal and actual cursor parameters.

Example 6-11 creates an explicit cursor whose two formal parameters represent a job and its maximum salary. When opened with a specified job and maximum salary, the cursor query selects the employees with that job who are overpaid (for each such employee, the query selects the first and last name and amount overpaid). Next, the example creates a procedure that prints the cursor query result set (for information about procedures, see [PL/SQL Subprograms](#)). Finally, the example opens the cursor with one set of actual parameters, prints the result set, closes the cursor, opens the cursor with different actual parameters, prints the result set, and closes the cursor.

Topics

- [Formal Cursor Parameters with Default Values](#)
- [Adding Formal Cursor Parameters with Default Values](#)

**See Also:**

- ["Explicit Cursor Declaration and Definition"](#) for more information about formal cursor parameters
- ["OPEN Statement"](#) for more information about actual cursor parameters

Example 6-11 Explicit Cursor that Accepts Parameters

```

DECLARE
  CURSOR c (job VARCHAR2, max_sal NUMBER) IS
    SELECT last_name, first_name, (salary - max_sal) overpayment
    FROM employees
    WHERE job_id = job
    AND salary > max_sal
    ORDER BY salary;

  PROCEDURE print_overpaid IS
    last_name_ employees.last_name%TYPE;
    first_name_ employees.first_name%TYPE;
    overpayment_ employees.salary%TYPE;
  BEGIN
    LOOP
      FETCH c INTO last_name_, first_name_, overpayment_;
      EXIT WHEN c%NOTFOUND;
      DBMS_OUTPUT.PUT_LINE(last_name_ || ', ' || first_name_ ||
        ' (by ' || overpayment_ || ')');
    END LOOP;
  END print_overpaid;

BEGIN
  DBMS_OUTPUT.PUT_LINE('-----');
  DBMS_OUTPUT.PUT_LINE('Overpaid Stock Clerks:');
  DBMS_OUTPUT.PUT_LINE('-----');
  OPEN c('ST_CLERK', 5000);

```

```

print_overpaid;
CLOSE c;

DBMS_OUTPUT.PUT_LINE('-----');
DBMS_OUTPUT.PUT_LINE('Overpaid Sales Representatives:');
DBMS_OUTPUT.PUT_LINE('-----');
OPEN c('SA_REP', 10000);
print_overpaid;
CLOSE c;
END;
/

```

Result:

```

-----
Overpaid Stock Clerks:
-----

-----
Overpaid Sales Representatives:
-----
Vishney, Clara (by 500)
Abel, Ellen (by 1000)
Ozer, Lisa (by 1500)

```

PL/SQL procedure successfully completed.

6.2.2.6.1 Formal Cursor Parameters with Default Values

When you create an explicit cursor with formal parameters, you can specify default values for them. When a formal parameter has a default value, its corresponding actual parameter is optional. If you open the cursor without specifying the actual parameter, then the formal parameter has its default value.

[Example 6-12](#) creates an explicit cursor whose formal parameter represents a location ID. The default value of the parameter is the location ID of company headquarters.

Example 6-12 Cursor Parameters with Default Values

```

DECLARE
CURSOR c (location NUMBER DEFAULT 1700) IS
    SELECT d.department_name,
           e.last_name manager,
           l.city
    FROM departments d, employees e, locations l
    WHERE l.location_id = location
           AND l.location_id = d.location_id
           AND d.department_id = e.department_id
    ORDER BY d.department_id;

PROCEDURE print_depts IS
    dept_name departments.department_name%TYPE;
    mgr_name employees.last_name%TYPE;
    city_name locations.city%TYPE;
BEGIN
    LOOP
        FETCH c INTO dept_name, mgr_name, city_name;
        EXIT WHEN c%NOTFOUND;
        DBMS_OUTPUT.PUT_LINE(dept_name || ' (Manager: ' || mgr_name || ')');
    END LOOP;
END print_depts;

```

```

BEGIN
  DBMS_OUTPUT.PUT_LINE('DEPARTMENTS AT HEADQUARTERS:');
  DBMS_OUTPUT.PUT_LINE('-----');
  OPEN c;
  print_depts;
  DBMS_OUTPUT.PUT_LINE('-----');
  CLOSE c;

  DBMS_OUTPUT.PUT_LINE('DEPARTMENTS IN CANADA:');
  DBMS_OUTPUT.PUT_LINE('-----');
  OPEN c(1800); -- Toronto
  print_depts;
  CLOSE c;
  OPEN c(1900); -- Whitehorse
  print_depts;
  CLOSE c;
END;
/

```

Result is similar to:

```

DEPARTMENTS AT HEADQUARTERS:
-----
Administration (Manager: Whalen)
Purchasing (Manager: Colmenares)
Purchasing (Manager: Baida)
Purchasing (Manager: Himuro)
Purchasing (Manager: Raphaely)
Purchasing (Manager: Khoo)
Purchasing (Manager: Tobias)
Executive (Manager: Kochhar)
Executive (Manager: De Haan)
Executive (Manager: King)
Finance (Manager: Popp)
Finance (Manager: Greenberg)
Finance (Manager: Faviert)
Finance (Manager: Chen)
Finance (Manager: Urman)
Finance (Manager: Sciarra)
Accounting (Manager: Gietz)
Accounting (Manager: Higgins)
-----
DEPARTMENTS IN CANADA:
-----
Marketing (Manager: Hartstein)
Marketing (Manager: Fay)

```

PL/SQL procedure successfully completed.

6.2.2.6.2 Adding Formal Cursor Parameters with Default Values

If you add formal parameters to a cursor, and you specify default values for the added parameters, then you need not change existing references to the cursor. Compare [Example 6-13](#) to [Example 6-11](#).

Example 6-13 Adding Formal Parameter to Existing Cursor

```

DECLARE
  CURSOR c (job VARCHAR2, max_sal NUMBER,
            hired DATE DEFAULT TO_DATE('31-DEC-1999', 'DD-MON-YYYY')) IS

```

```

SELECT last_name, first_name, (salary - max_sal) overpayment
FROM employees
WHERE job_id = job
AND salary > max_sal
AND hire_date > hired
ORDER BY salary;

PROCEDURE print_overpaid IS
  last_name_   employees.last_name%TYPE;
  first_name_  employees.first_name%TYPE;
  overpayment_ employees.salary%TYPE;
BEGIN
  LOOP
    FETCH c INTO last_name_, first_name_, overpayment_;
    EXIT WHEN c%NOTFOUND;
    DBMS_OUTPUT.PUT_LINE(last_name_ || ', ' || first_name_ ||
      ' (by ' || overpayment_ || ')');
  END LOOP;
END print_overpaid;

BEGIN
  DBMS_OUTPUT.PUT_LINE('-----');
  DBMS_OUTPUT.PUT_LINE('Overpaid Sales Representatives:');
  DBMS_OUTPUT.PUT_LINE('-----');
  OPEN c('SA_REP', 10000); -- existing reference
  print_overpaid;
  CLOSE c;

  DBMS_OUTPUT.PUT_LINE('-----');
  DBMS_OUTPUT.PUT_LINE('Overpaid Sales Representatives Hired After 2004:');
  DBMS_OUTPUT.PUT_LINE('-----');
  OPEN c('SA_REP', 10000, TO_DATE('31-DEC-2004', 'DD-MON-YYYY'));
    -- new reference

  print_overpaid;
  CLOSE c;
END;
/

```

Result:

```

-----
Overpaid Sales Representatives:
-----
Vishney, Clara (by 500)
Abel, Ellen (by 1000)
Ozer, Lisa (by 1500)
-----
Overpaid Sales Representatives Hired After 2004:
-----
Vishney, Clara (by 500)
Ozer, Lisa (by 1500)

```

PL/SQL procedure successfully completed.

6.2.2.7 Explicit Cursor Attributes

The syntax for the value of an explicit cursor attribute is *cursor_name* immediately followed by *attribute* (for example, *c1%ISOPEN*).

 **Note:**

Explicit cursors and cursor variables (named cursors) have the same attributes. This topic applies to all named cursors except where noted.

The explicit cursor attributes are:

- **%ISOPEN Attribute:** Is the Cursor Open?
- **%FOUND Attribute:** Has a Row Been Fetched?
- **%NOTFOUND Attribute:** Has No Row Been Fetched?
- **%ROWCOUNT Attribute:** How Many Rows Were Fetched?

If an explicit cursor is not open, referencing any attribute except `%ISOPEN` raises the predefined exception `INVALID_CURSOR`.

 **See Also:**

"[Named Cursor Attribute](#)" for complete syntax and semantics of named cursor (explicit cursor and cursor variable) attributes

6.2.2.7.1 %ISOPEN Attribute: Is the Cursor Open?

`%ISOPEN` returns `TRUE` if its explicit cursor is open; `FALSE` otherwise.

`%ISOPEN` is useful for:

- Checking that an explicit cursor is not already open before you try to open it.
If you try to open an explicit cursor that is already open, PL/SQL raises the predefined exception `CURSOR_ALREADY_OPEN`. You must close an explicit cursor before you can reopen it.

 **Note:**

The preceding paragraph does not apply to cursor variables.

- Checking that an explicit cursor is open before you try to close it.

Example 6-14 opens the explicit cursor `c1` only if it is not open and closes it only if it is open.

Example 6-14 %ISOPEN Explicit Cursor Attribute

```
DECLARE
  CURSOR c1 IS
    SELECT last_name, salary FROM employees
    WHERE ROWNUM < 11;

  the_name employees.last_name%TYPE;
  the_salary employees.salary%TYPE;
BEGIN
```

```

IF NOT c1%ISOPEN THEN
    OPEN c1;
END IF;

FETCH c1 INTO the_name, the_salary;

IF c1%ISOPEN THEN
    CLOSE c1;
END IF;
END;
/

```

6.2.2.7.2 %FOUND Attribute: Has a Row Been Fetched?

%FOUND returns:

- NULL after the explicit cursor is opened but before the first fetch
- TRUE if the most recent fetch from the explicit cursor returned a row
- FALSE otherwise

%FOUND is useful for determining whether there is a fetched row to process.

[Example 6-15](#) loops through a result set, printing each fetched row and exiting when there are no more rows to fetch.

Example 6-15 %FOUND Explicit Cursor Attribute

```

DECLARE
    CURSOR c1 IS
        SELECT last_name, salary FROM employees
        WHERE ROWNUM < 11
        ORDER BY last_name;

    my_ename employees.last_name%TYPE;
    my_salary employees.salary%TYPE;
BEGIN
    OPEN c1;
    LOOP
        FETCH c1 INTO my_ename, my_salary;
        IF c1%FOUND THEN -- fetch succeeded
            DBMS_OUTPUT.PUT_LINE('Name = ' || my_ename || ', salary = ' || my_salary);
        ELSE -- fetch failed
            EXIT;
        END IF;
    END LOOP;
END;
/

```

Result:

```

Name = Austin, salary = 4800
Name = De Haan, salary = 17000
Name = Ernst, salary = 6000
Name = Faviet, salary = 9000
Name = Greenberg, salary = 12008
Name = Hunold, salary = 9000
Name = King, salary = 24000
Name = Kochhar, salary = 17000
Name = Lorentz, salary = 4200
Name = Pataballa, salary = 4800

```

6.2.2.7.3 %NOTFOUND Attribute: Has No Row Been Fetched?

`%NOTFOUND` (the logical opposite of `%FOUND`) returns:

- `NULL` after the explicit cursor is opened but before the first fetch
- `FALSE` if the most recent fetch from the explicit cursor returned a row
- `TRUE` otherwise

`%NOTFOUND` is useful for exiting a loop when `FETCH` fails to return a row, as in [Example 6-16](#).

Example 6-16 %NOTFOUND Explicit Cursor Attribute

```
DECLARE
  CURSOR c1 IS
    SELECT last_name, salary FROM employees
    WHERE ROWNUM < 11
    ORDER BY last_name;

  my_ename employees.last_name%TYPE;
  my_salary employees.salary%TYPE;
BEGIN
  OPEN c1;
  LOOP
    FETCH c1 INTO my_ename, my_salary;
    IF c1%NOTFOUND THEN -- fetch failed
      EXIT;
    ELSE -- fetch succeeded
      DBMS_OUTPUT.PUT_LINE
        ('Name = ' || my_ename || ', salary = ' || my_salary);
    END IF;
  END LOOP;
END;
```

Result:

```
Name = Austin, salary = 4800
Name = De Haan, salary = 17000
Name = Ernst, salary = 6000
Name = Favier, salary = 9000
Name = Greenberg, salary = 12008
Name = Hunold, salary = 9000
Name = King, salary = 24000
Name = Kochhar, salary = 17000
Name = Lorentz, salary = 4200
Name = Pataballa, salary = 4800
```

6.2.2.7.4 %ROWCOUNT Attribute: How Many Rows Were Fetched?

`%ROWCOUNT` returns:

- Zero after the explicit cursor is opened but before the first fetch
- Otherwise, the number of rows fetched (an `INTEGER`)

 **Note:**

If a server is Oracle Database 12c or later and its client is Oracle Database 11g2 or earlier (or the reverse), then the maximum number that `SQL%ROWCOUNT` returns is 4,294,967,295.

Example 6-17 numbers and prints the rows that it fetches and prints a message after fetching the fifth row.

Example 6-17 %ROWCOUNT Explicit Cursor Attribute

```
DECLARE
  CURSOR c1 IS
    SELECT last_name FROM employees
    WHERE ROWNUM < 11
    ORDER BY last_name;

  name employees.last_name%TYPE;
BEGIN
  OPEN c1;
  LOOP
    FETCH c1 INTO name;
    EXIT WHEN c1%NOTFOUND OR c1%NOTFOUND IS NULL;
    DBMS_OUTPUT.PUT_LINE(c1%ROWCOUNT || '. ' || name);
    IF c1%ROWCOUNT = 5 THEN
      DBMS_OUTPUT.PUT_LINE('--- Fetched 5th row ---');
    END IF;
  END LOOP;
  CLOSE c1;
END;
/
```

Result:

```
1. Abel
2. Ande
3. Atkinson
4. Austin
5. Baer
--- Fetched 5th row ---
6. Baida
7. Banda
8. Bates
9. Bell
10. Bernstein
```

6.3 Processing Query Result Sets

In PL/SQL, as in traditional database programming, you use cursors to process query result sets. However, in PL/SQL, you can use either implicit or explicit cursors.

The former need less code, but the latter are more flexible. For example, explicit cursors can accept parameters.

The following PL/SQL statements use implicit cursors that PL/SQL defines and manages for you:

- `SELECT INTO`

- **Implicit cursor** `FOR LOOP`

The following PL/SQL statements use explicit cursors:

- **Explicit cursor** `FOR LOOP`

You define the explicit cursor, but PL/SQL manages it while the statement runs.

- `OPEN`, `FETCH`, and `CLOSE`

You define and manage the explicit cursor.



Note:

If a query returns no rows, PL/SQL raises the exception `NO_DATA_FOUND`.

Topics

- [Processing Query Result Sets With `SELECT INTO` Statements](#)
- [Processing Query Result Sets With `Cursor FOR LOOP` Statements](#)
- [Processing Query Result Sets With Explicit Cursors, `OPEN`, `FETCH`, and `CLOSE`](#)
- [Processing Query Result Sets with Subqueries](#)



See Also:

- ["Explicit Cursors that Accept Parameters"](#)
- *Oracle Database Development Guide* for information about returning result sets to clients
- ["Exception Handler"](#) for information about handling exceptions

6.3.1 Processing Query Result Sets With `SELECT INTO` Statements

Using an implicit cursor, the `SELECT INTO` statement retrieves values from one or more database tables (as the SQL `SELECT` statement does) and stores them in variables (which the SQL `SELECT` statement does not do).

Topics

- [Handling Single-Row Result Sets](#)
- [Handling Large Multiple-Row Result Sets](#)



See Also:

["SELECT INTO Statement"](#) for its complete syntax and semantics

6.3.1.1 Handling Single-Row Result Sets

If you expect the query to return only one row, then use the `SELECT INTO` statement to store values from that row in either one or more scalar variables, or one record variable.

If the query might return multiple rows, but you care about only the *n*th row, then restrict the result set to that row with the clause `WHERE ROWNUM=n`.



See Also:

- ["Assigning Values to Variables with the SELECT INTO Statement"](#)
- ["Using SELECT INTO to Assign a Row to a Record Variable"](#)
- *Oracle Database SQL Language Reference* for more information about the `ROWNUM` pseudocolumn

6.3.1.2 Handling Large Multiple-Row Result Sets

If you must assign a large quantity of table data to variables, Oracle recommends using the `SELECT INTO` statement with the `BULK COLLECT` clause.

This statement retrieves an entire result set into one or more collection variables.

For more information, see ["SELECT INTO Statement with BULK COLLECT Clause"](#).

6.3.2 Processing Query Result Sets With Cursor FOR LOOP Statements

The cursor `FOR LOOP` statement lets you run a `SELECT` statement and then immediately loop through the rows of the result set.

This statement can use either an implicit or explicit cursor (but not a cursor variable).

If you use the `SELECT` statement only in the cursor `FOR LOOP` statement, then specify the `SELECT` statement inside the cursor `FOR LOOP` statement, as in [Example 6-18](#). This form of the cursor `FOR LOOP` statement uses an implicit cursor, and is called an **implicit cursor FOR LOOP statement**. Because the implicit cursor is internal to the statement, you cannot reference it with the name `SQL`.

If you use the `SELECT` statement multiple times in the same PL/SQL unit, then define an explicit cursor for it and specify that cursor in the cursor `FOR LOOP` statement, as in [Example 6-19](#). This form of the cursor `FOR LOOP` statement is called an **explicit cursor FOR LOOP statement**. You can use the same explicit cursor elsewhere in the same PL/SQL unit.

The cursor `FOR LOOP` statement implicitly declares its loop index as a `%ROWTYPE` record variable of the type that its cursor returns. This record is local to the loop and exists only during loop execution. Statements inside the loop can reference the record and its fields. They can reference virtual columns only by aliases, as in [Example 6-21](#).

After declaring the loop index record variable, the `FOR LOOP` statement opens the specified cursor. With each iteration of the loop, the `FOR LOOP` statement fetches a row from the result set and stores it in the record. When there are no more rows to fetch, the cursor `FOR LOOP` statement closes the cursor. The cursor also closes if a statement inside the loop transfers control outside the loop or if PL/SQL raises an exception.

**See Also:**

"[Cursor FOR LOOP Statement](#)" for its complete syntax and semantics

**Note:**

When an exception is raised inside a cursor `FOR LOOP` statement, the cursor closes before the exception handler runs. Therefore, the values of explicit cursor attributes are not available in the handler.

Example 6-18 Implicit Cursor FOR LOOP Statement

In this example, an implicit cursor `FOR LOOP` statement prints the last name and job ID of every clerk whose manager has an ID greater than 120.

```
BEGIN
  FOR item IN (
    SELECT last_name, job_id
    FROM employees
    WHERE job_id LIKE '%CLERK%'
    AND manager_id > 120
    ORDER BY last_name
  )
  LOOP
    DBMS_OUTPUT.PUT_LINE
      ('Name = ' || item.last_name || ', Job = ' || item.job_id);
  END LOOP;
END;
/
```

Result:

```
Name = Atkinson, Job = ST_CLERK
Name = Bell, Job = SH_CLERK
Name = Bissot, Job = ST_CLERK
...
Name = Walsh, Job = SH_CLERK
```

Example 6-19 Explicit Cursor FOR LOOP Statement

This example is like [Example 6-18](#), except that it uses an explicit cursor `FOR LOOP` statement.

```
DECLARE
  CURSOR c1 IS
    SELECT last_name, job_id FROM employees
    WHERE job_id LIKE '%CLERK%' AND manager_id > 120
    ORDER BY last_name;
BEGIN
```

```

FOR item IN c1
LOOP
  DBMS_OUTPUT.PUT_LINE
    ('Name = ' || item.last_name || ', Job = ' || item.job_id);
END LOOP;
END;
/

```

Result:

```

Name = Atkinson, Job = ST_CLERK
Name = Bell, Job = SH_CLERK
Name = Bissot, Job = ST_CLERK
...
Name = Walsh, Job = SH_CLERK

```

Example 6-20 Passing Parameters to Explicit Cursor FOR LOOP Statement

This example declares and defines an explicit cursor that accepts two parameters, and then uses it in an explicit cursor `FOR LOOP` statement to display the wages paid to employees who earn more than a specified wage in a specified department.

```

DECLARE
  CURSOR c1 (job VARCHAR2, max_wage NUMBER) IS
    SELECT * FROM employees
      WHERE job_id = job
      AND salary > max_wage;
BEGIN
  FOR person IN c1('ST_CLERK', 3000)
  LOOP
    -- process data record
    DBMS_OUTPUT.PUT_LINE (
      'Name = ' || person.last_name || ', salary = ' ||
      person.salary || ', Job Id = ' || person.job_id
    );
  END LOOP;
END;
/

```

Result:

```

Name = Nayer, salary = 3200, Job Id = ST_CLERK
Name = Bissot, salary = 3300, Job Id = ST_CLERK
Name = Mallin, salary = 3300, Job Id = ST_CLERK
Name = Ladwig, salary = 3600, Job Id = ST_CLERK
Name = Stiles, salary = 3200, Job Id = ST_CLERK
Name = Rajs, salary = 3500, Job Id = ST_CLERK
Name = Davies, salary = 3100, Job Id = ST_CLERK

```

Example 6-21 Cursor FOR Loop References Virtual Columns

In this example, the implicit cursor `FOR LOOP` references virtual columns by their aliases, `full_name` and `dream_salary`.

```

BEGIN
  FOR item IN (
    SELECT first_name || ' ' || last_name AS full_name,
           salary * 10 AS dream_salary
    FROM employees
    WHERE ROWNUM <= 5
    ORDER BY dream_salary DESC, last_name ASC
  ) LOOP

```



```

        DBMS_OUTPUT.PUT_LINE
        (item.full_name || ' dreams of making ' || item.dream_salary);
    END LOOP;
END;
/

```

Result:

```

Stephen King dreams of making 240000
Lex De Haan dreams of making 170000
Neena Kochhar dreams of making 170000
Alexander Hunold dreams of making 90000
Bruce Ernst dreams of making 60000

```

6.3.3 Processing Query Result Sets With Explicit Cursors, OPEN, FETCH, and CLOSE

For full control over query result set processing, declare explicit cursors and manage them with the statements OPEN, FETCH, and CLOSE.

This result set processing technique is more complicated than the others, but it is also more flexible. For example, you can:

- Process multiple result sets in parallel, using multiple cursors.
- Process multiple rows in a single loop iteration, skip rows, or split the processing into multiple loops.
- Specify the query in one PL/SQL unit but retrieve the rows in another.

For instructions and examples, see "[Explicit Cursors](#)".

6.3.4 Processing Query Result Sets with Subqueries

If you process a query result set by looping through it and running another query for each row, then you can improve performance by removing the second query from inside the loop and making it a subquery of the first query.

While an ordinary subquery is evaluated for each table, a **correlated subquery** is evaluated for each row.

For more information about subqueries, see *Oracle Database SQL Language Reference*.

Example 6-22 Subquery in FROM Clause of Parent Query

This example defines explicit cursor `c1` with a query whose FROM clause contains a subquery.

```

DECLARE
    CURSOR c1 IS
        SELECT t1.department_id, department_name, staff
        FROM departments t1,
            ( SELECT department_id, COUNT(*) AS staff
              FROM employees
              GROUP BY department_id
            ) t2
        WHERE (t1.department_id = t2.department_id) AND staff >= 5
        ORDER BY staff;

BEGIN
    FOR dept IN c1

```

```

LOOP
  DBMS_OUTPUT.PUT_LINE ('Department = '
    || dept.department_name || ', staff = ' || dept.staff);
END LOOP;
END;
/

```

Result:

```

Department = IT, staff = 5
Department = Finance, staff = 6
Department = Purchasing, staff = 6
Department = Sales, staff = 34
Department = Shipping, staff = 45

```

Example 6-23 Correlated Subquery

This example returns the name and salary of each employee whose salary exceeds the departmental average. For each row in the table, the correlated subquery computes the average salary for the corresponding department.

```

DECLARE
  CURSOR c1 IS
    SELECT department_id, last_name, salary
    FROM employees t
    WHERE salary > ( SELECT AVG(salary)
                     FROM employees
                     WHERE t.department_id = department_id
                   )
    ORDER BY department_id, last_name;
BEGIN
  FOR person IN c1
  LOOP
    DBMS_OUTPUT.PUT_LINE('Making above-average salary = ' || person.last_name);
  END LOOP;
END;
/

```

Result:

```

Making above-average salary = Hartstein
Making above-average salary = Raphaely
Making above-average salary = Bell
...
Making above-average salary = Higgins

```

6.4 Cursor Variables

A **cursor variable** is like an explicit cursor, except that:

- It is not limited to one query.
You can open a cursor variable for a query, process the result set, and then use the cursor variable for another query.
- You can assign a value to it.
- You can use it in an expression.
- It can be a subprogram parameter.
You can use cursor variables to pass query result sets between subprograms.

- It can be a host variable.
You can use cursor variables to pass query result sets between PL/SQL stored subprograms and their clients.
- It cannot accept parameters.
You cannot pass parameters to a cursor variable, but you can pass whole queries to it. The queries can include variables.

A cursor variable has this flexibility because it is a pointer; that is, its value is the address of an item, not the item itself.

Before you can reference a cursor variable, you must make it point to a SQL work area, either by opening it or by assigning it the value of an open PL/SQL cursor variable or open host cursor variable.

 **Note:**

Cursor variables and explicit cursors are not interchangeable—you cannot use one where the other is expected. For example, you cannot reference a cursor variable in a cursor `FOR LOOP` statement.

Topics

- [Creating Cursor Variables](#)
- [Opening and Closing Cursor Variables](#)
- [Fetching Data with Cursor Variables](#)
- [Assigning Values to Cursor Variables](#)
- [Variables in Cursor Variable Queries](#)
- [Querying a Collection](#)
- [Cursor Variable Attributes](#)
- [Cursor Variables as Subprogram Parameters](#)
- [Cursor Variables as Host Variables](#)

 **See Also:**

- ["Explicit Cursors"](#) for more information about explicit cursors
- ["Restrictions on Cursor Variables"](#)
- *Oracle Database Development Guide* for advantages of cursor variables
- *Oracle Database Development Guide* for disadvantages of cursor variables

6.4.1 Creating Cursor Variables

To create a cursor variable, either declare a variable of the predefined type `SYS_REFCURSOR` or define a `REF CURSOR` type and then declare a variable of that type.

 **Note:**

Informally, a cursor variable is sometimes called a `REF CURSOR`).

The basic syntax of a `REF CURSOR` type definition is:

```
TYPE type_name IS REF CURSOR [ RETURN return_type ]
```

For the complete syntax and semantics, see "[Cursor Variable Declaration](#)".

If you specify *return_type*, then the `REF CURSOR` type and cursor variables of that type are **strong**; if not, they are **weak**. `SYS_REFCURSOR` and cursor variables of that type are weak.

With a strong cursor variable, you can associate only queries that return the specified type. With a weak cursor variable, you can associate any query.

Weak cursor variables are more error-prone than strong ones, but they are also more flexible. Weak `REF CURSOR` types are interchangeable with each other and with the predefined type `SYS_REFCURSOR`. You can assign the value of a weak cursor variable to any other weak cursor variable.

You can assign the value of a strong cursor variable to another strong cursor variable only if both cursor variables have the same type (not merely the same return type).

 **Note:**

You can partition weak cursor variable arguments to table functions only with the `PARTITION BY ANY` clause, not with `PARTITION BY RANGE` or `PARTITION BY HASH`.

For syntax and semantics, see "[PARALLEL_ENABLE Clause](#)".

Example 6-24 Cursor Variable Declarations

This example defines strong and weak `REF CURSOR` types, variables of those types, and a variable of the predefined type `SYS_REFCURSOR`.

```
DECLARE
  TYPE empcurtyp IS REF CURSOR RETURN employees%ROWTYPE; -- strong type
  TYPE genericcurtyp IS REF CURSOR; -- weak type

  cursor1 empcurtyp; -- strong cursor variable
  cursor2 genericcurtyp; -- weak cursor variable
  my_cursor SYS_REFCURSOR; -- weak cursor variable
```

```
TYPE deptcurtyp IS REF CURSOR RETURN departments%ROWTYPE; -- strong type
dept_cv deptcurtyp; -- strong cursor variable
BEGIN
  NULL;
END;
/
```

Example 6-25 Cursor Variable with User-Defined Return Type

In this example, *EmpRecTyp* is a user-defined RECORD type.

```
DECLARE
  TYPE EmpRecTyp IS RECORD (
    employee_id NUMBER,
    last_name VARCHAR2(25),
    salary NUMBER(8,2));

  TYPE EmpCurTyp IS REF CURSOR RETURN EmpRecTyp;
  emp_cv EmpCurTyp;
BEGIN
  NULL;
END;
/
```

6.4.2 Opening and Closing Cursor Variables

After declaring a cursor variable, you can open it with the `OPEN FOR` statement, which does the following:

1. Associates the cursor variable with a query (typically, the query returns multiple rows)
The query can include placeholders for bind variables, whose values you specify in the `USING` clause of the `OPEN FOR` statement.
2. Allocates database resources to process the query
3. Processes the query; that is:
 - a. Identifies the result set
If the query references variables, their values affect the result set. For details, see ["Variables in Cursor Variable Queries"](#).
 - b. If the query has a `FOR UPDATE` clause, locks the rows of the result set
For details, see ["SELECT FOR UPDATE and FOR UPDATE Cursors"](#).
4. Positions the cursor before the first row of the result set

You need not close a cursor variable before reopening it (that is, using it in another `OPEN FOR` statement). After you reopen a cursor variable, the query previously associated with it is lost.

When you no longer need a cursor variable, close it with the `CLOSE` statement, thereby allowing its resources to be reused. After closing a cursor variable, you cannot fetch records from its result set or reference its attributes. If you try, PL/SQL raises the predefined exception `INVALID_CURSOR`.

You can reopen a closed cursor variable.

 See Also:

- ["OPEN FOR Statement"](#) for its syntax and semantics
- ["CLOSE Statement"](#) for its syntax and semantics

6.4.3 Fetching Data with Cursor Variables

After opening a cursor variable, you can fetch the rows of the query result set with the `FETCH` statement.

The return type of the cursor variable must be compatible with the `into_clause` of the `FETCH` statement. If the cursor variable is strong, PL/SQL catches incompatibility at compile time. If the cursor variable is weak, PL/SQL catches incompatibility at run time, raising the predefined exception `ROWTYPE_MISMATCH` before the first fetch.

 See Also:

- ["Fetching Data with Explicit Cursors"](#)
- ["FETCH Statement"](#) for its complete syntax and semantics
- ["FETCH Statement with BULK COLLECT Clause"](#) for information about `FETCH` statements that return more than one row at a time

Example 6-26 Fetching Data with Cursor Variables

This example uses one cursor variable to do what [Example 6-6](#) does with two explicit cursors. The first `OPEN FOR` statement includes the query itself. The second `OPEN FOR` statement references a variable whose value is a query.

```

DECLARE
  cv SYS_REFCURSOR; -- cursor variable

  v_lastname employees.last_name%TYPE; -- variable for last_name
  v_jobid     employees.job_id%TYPE;   -- variable for job_id

  query_2 VARCHAR2(200) :=
    'SELECT * FROM employees
     WHERE REGEXP_LIKE (job_id, ''[ACADFIMKSA]_M[ANGR]'')
     ORDER BY job_id';

  v_employees employees%ROWTYPE; -- record variable row of table

BEGIN
  OPEN cv FOR
    SELECT last_name, job_id FROM employees
    WHERE REGEXP_LIKE (job_id, 'S[HT]_CLERK')
    ORDER BY last_name;

  LOOP -- Fetches 2 columns into variables
    FETCH cv INTO v_lastname, v_jobid;
    EXIT WHEN cv%NOTFOUND;
  
```

```

        DBMS_OUTPUT.PUT_LINE( RPAD(v_lastname, 25, ' ') || v_jobid );
    END LOOP;

    DBMS_OUTPUT.PUT_LINE( '-----' );

    OPEN cv FOR query_2;

    LOOP -- Fetches entire row into the v_employees record
        FETCH cv INTO v_employees;
        EXIT WHEN cv%NOTFOUND;
        DBMS_OUTPUT.PUT_LINE( RPAD(v_employees.last_name, 25, ' ') ||
                               v_employees.job_id );
    END LOOP;

    CLOSE cv;
END;
/

```

Result:

```

Atkinson          ST_CLERK
Bell              SH_CLERK
Bissot            ST_CLERK
...
Walsh             SH_CLERK
-----
Higgins           AC_MGR
Greenberg         FI_MGR
Hartstein         MK_MAN
...
Zlotkey           SA_MAN

```

Example 6-27 Fetching from Cursor Variable into Collections

This example fetches from a cursor variable into two collections (nested tables), using the BULK COLLECT clause of the FETCH statement.

```

DECLARE
    TYPE empcurtyp IS REF CURSOR;
    TYPE namelist IS TABLE OF employees.last_name%TYPE;
    TYPE sallist IS TABLE OF employees.salary%TYPE;
    emp_cv empcurtyp;
    names  namelist;
    sals   sallist;
BEGIN
    OPEN emp_cv FOR
        SELECT last_name, salary FROM employees
        WHERE job_id = 'SA_REP'
        ORDER BY salary DESC;

    FETCH emp_cv BULK COLLECT INTO names, sals;
    CLOSE emp_cv;
    -- loop through the names and sals collections
    FOR i IN names.FIRST .. names.LAST
    LOOP
        DBMS_OUTPUT.PUT_LINE
            ('Name = ' || names(i) || ', salary = ' || sals(i));
    END LOOP;
END;
/

```

Result:

```
Name = Ozer, salary = 11500
Name = Abel, salary = 11000
Name = Vishney, salary = 10500
...
Name = Kumar, salary = 6100
```

6.4.4 Assigning Values to Cursor Variables

You can assign to a PL/SQL cursor variable the value of another PL/SQL cursor variable or host cursor variable.

The syntax is:

```
target_cursor_variable := source_cursor_variable;
```

If *source_cursor_variable* is open, then after the assignment, *target_cursor_variable* is also open. The two cursor variables point to the same SQL work area.

If *source_cursor_variable* is not open, opening *target_cursor_variable* after the assignment does not open *source_cursor_variable*.

6.4.5 Variables in Cursor Variable Queries

The query associated with a cursor variable can reference any variable in its scope.

When you open a cursor variable with the `OPEN FOR` statement, PL/SQL evaluates any variables in the query and uses those values when identifying the result set. Changing the values of the variables later does not change the result set.

To change the result set, you must change the value of the variable and then open the cursor variable again for the same query, as in [Example 6-29](#).

Example 6-28 Variable in Cursor Variable Query—No Result Set Change

This example opens a cursor variable for a query that references the variable `factor`, which has the value 2. Therefore, `sal_multiple` is always 2 times `sal`, despite that `factor` is incremented after every fetch.

```
DECLARE
    sal            employees.salary%TYPE;
    sal_multiple  employees.salary%TYPE;
    factor        INTEGER := 2;

    cv SYS_REFCURSOR;

BEGIN
    OPEN cv FOR
        SELECT salary, salary*factor
        FROM employees
        WHERE job_id LIKE 'AD_%';  -- PL/SQL evaluates factor

    LOOP
        FETCH cv INTO sal, sal_multiple;
        EXIT WHEN cv%NOTFOUND;
        DBMS_OUTPUT.PUT_LINE('factor = ' || factor);
        DBMS_OUTPUT.PUT_LINE('sal      = ' || sal);
    END LOOP;
```



```

        DBMS_OUTPUT.PUT_LINE('sal_multiple = ' || sal_multiple);
        factor := factor + 1; -- Does not affect sal_multiple
    END LOOP;

    CLOSE cv;
END;
/

```

Result:

```

factor = 2
sal      = 4400
sal_multiple = 8800
factor = 3
sal      = 24000
sal_multiple = 48000
factor = 4
sal      = 17000
sal_multiple = 34000
factor = 5
sal      = 17000
sal_multiple = 34000

```

Example 6-29 Variable in Cursor Variable Query—Result Set Change

```

DECLARE
    sal      employees.salary%TYPE;
    sal_multiple employees.salary%TYPE;
    factor   INTEGER := 2;

    cv SYS_REFCURSOR;

BEGIN
    DBMS_OUTPUT.PUT_LINE('factor = ' || factor);

    OPEN cv FOR
        SELECT salary, salary*factor
        FROM employees
        WHERE job_id LIKE 'AD_%'; -- PL/SQL evaluates factor

    LOOP
        FETCH cv INTO sal, sal_multiple;
        EXIT WHEN cv%NOTFOUND;
        DBMS_OUTPUT.PUT_LINE('sal      = ' || sal);
        DBMS_OUTPUT.PUT_LINE('sal_multiple = ' || sal_multiple);
    END LOOP;

    factor := factor + 1;

    DBMS_OUTPUT.PUT_LINE('factor = ' || factor);

    OPEN cv FOR
        SELECT salary, salary*factor
        FROM employees
        WHERE job_id LIKE 'AD_%'; -- PL/SQL evaluates factor

    LOOP
        FETCH cv INTO sal, sal_multiple;
        EXIT WHEN cv%NOTFOUND;
        DBMS_OUTPUT.PUT_LINE('sal      = ' || sal);
        DBMS_OUTPUT.PUT_LINE('sal_multiple = ' || sal_multiple);
    END LOOP;

```

```
END LOOP;

CLOSE cv;
END;
/
```

Result:

```
factor = 2
sal      = 4400
sal_multiple = 8800
sal      = 24000
sal_multiple = 48000
sal      = 17000
sal_multiple = 34000
sal      = 17000
sal_multiple = 34000
factor = 3
sal      = 4400
sal_multiple = 13200
sal      = 24000
sal_multiple = 72000
sal      = 17000
sal_multiple = 51000
sal      = 17000
sal_multiple = 51000
```

6.4.6 Querying a Collection

You can query a collection if all of the following are true:

- The data type of the collection was either created at schema level or declared in a package specification.
- The data type of the collection element is either a scalar data type, a user-defined type, or a record type.

In the query `FROM` clause, the collection appears in *table_collection_expression* as the argument of the `TABLE` operator.

**Note:**

In SQL contexts, you cannot use a function whose return type was declared in a package specification.

 See Also:

- *Oracle Database SQL Language Reference* for information about the `table_collection_expression`
- "[CREATE PACKAGE Statement](#)" for information about the `CREATE PACKAGE` statement
- "[PL/SQL Collections and Records](#)" for information about collection types and collection variables
- [Example 7-9](#), "Querying a Collection with Native Dynamic SQL"

Example 6-30 Querying a Collection with Static SQL

In this example, the cursor variable is associated with a query on an associative array of records. The nested table type, `mytab`, is declared in a package specification.

```
CREATE OR REPLACE PACKAGE pkg AUTHID DEFINER AS
  TYPE rec IS RECORD(f1 NUMBER, f2 VARCHAR2(30));
  TYPE mytab IS TABLE OF rec INDEX BY pls_integer;
END;

DECLARE
  v1 pkg.mytab; -- collection of records
  v2 pkg.rec;
  c1 SYS_REFCURSOR;
BEGIN
  v1(1).f1 := 1;
  v1(1).f2 := 'one';
  OPEN c1 FOR SELECT * FROM TABLE(v1);
  FETCH c1 INTO v2;
  CLOSE c1;
  DBMS_OUTPUT.PUT_LINE('Values in record are ' || v2.f1 || ' and ' || v2.f2);
END;
/
```

Result:

Values in record are 1 and one

6.4.7 Cursor Variable Attributes

A cursor variable has the same attributes as an explicit cursor (see [Explicit Cursor Attributes](#)). The syntax for the value of a cursor variable attribute is `cursor_variable_name attribute` (for example, `cv%ISOPEN`). If a cursor variable is not open, referencing any attribute except `%ISOPEN` raises the predefined exception `INVALID_CURSOR`.

6.4.8 Cursor Variables as Subprogram Parameters

You can use a cursor variable as a subprogram parameter, which makes it useful for passing query results between subprograms.

For example:

- You can open a cursor variable in one subprogram and process it in a different subprogram.
- In a multilanguage application, a PL/SQL subprogram can use a cursor variable to return a result set to a subprogram written in a different language.

 **Note:**

The invoking and invoked subprograms must be in the same database instance. You cannot pass or return cursor variables to subprograms invoked through database links.

 **Caution:**

Because cursor variables are pointers, using them as subprogram parameters increases the likelihood of subprogram parameter aliasing, which can have unintended results. For more information, see "[Subprogram Parameter Aliasing with Cursor Variable Parameters](#)".

When declaring a cursor variable as the formal parameter of a subprogram:

- If the subprogram opens or assigns a value to the cursor variable, then the parameter mode must be `IN OUT`.
- If the subprogram only fetches from, or closes, the cursor variable, then the parameter mode can be either `IN` or `IN OUT`.

Corresponding formal and actual cursor variable parameters must have compatible return types. Otherwise, PL/SQL raises the predefined exception `ROWTYPE_MISMATCH`.

To pass a cursor variable parameter between subprograms in different PL/SQL units, define the `REF CURSOR` type of the parameter in a package. When the type is in a package, multiple subprograms can use it. One subprogram can declare a formal parameter of that type, and other subprograms can declare variables of that type and pass them to the first subprogram.

 **See Also:**

-
- "[Subprogram Parameters](#)" for more information about subprogram parameters
- "[CURSOR Expressions](#)" for information about `CURSOR` expressions, which can be actual parameters for formal cursor variable parameters
- [PL/SQL Packages](#), for more information about packages

Example 6-31 Procedure to Open Cursor Variable for One Query

This example defines, in a package, a REF CURSOR type and a procedure that opens a cursor variable parameter of that type.

```
CREATE OR REPLACE PACKAGE emp_data AUTHID DEFINER AS
  TYPE empcurtyp IS REF CURSOR RETURN employees%ROWTYPE;
  PROCEDURE open_emp_cv (emp_cv IN OUT empcurtyp);
END emp_data;
/
CREATE OR REPLACE PACKAGE BODY emp_data AS
  PROCEDURE open_emp_cv (emp_cv IN OUT EmpCurTyp) IS
  BEGIN
    OPEN emp_cv FOR SELECT * FROM employees;
  END open_emp_cv;
END emp_data;
/
```

Example 6-32 Opening Cursor Variable for Chosen Query (Same Return Type)

In this example ,the stored procedure opens its cursor variable parameter for a chosen query. The queries have the same return type.

```
CREATE OR REPLACE PACKAGE emp_data AUTHID DEFINER AS
  TYPE empcurtyp IS REF CURSOR RETURN employees%ROWTYPE;
  PROCEDURE open_emp_cv (emp_cv IN OUT empcurtyp, choice INT);
END emp_data;
/
CREATE OR REPLACE PACKAGE BODY emp_data AS
  PROCEDURE open_emp_cv (emp_cv IN OUT empcurtyp, choice INT) IS
  BEGIN
    IF choice = 1 THEN
      OPEN emp_cv FOR SELECT *
      FROM employees
      WHERE commission_pct IS NOT NULL;
    ELSIF choice = 2 THEN
      OPEN emp_cv FOR SELECT *
      FROM employees
      WHERE salary > 2500;
    ELSIF choice = 3 THEN
      OPEN emp_cv FOR SELECT *
      FROM employees
      WHERE department_id = 100;
    END IF;
  END;
END emp_data;
/
```

Example 6-33 Opening Cursor Variable for Chosen Query (Different Return Types)

In this example,the stored procedure opens its cursor variable parameter for a chosen query. The queries have the different return types.

```
CREATE OR REPLACE PACKAGE admin_data AUTHID DEFINER AS
  TYPE gencurtyp IS REF CURSOR;
  PROCEDURE open_cv (generic_cv IN OUT gencurtyp, choice INT);
END admin_data;
/
CREATE OR REPLACE PACKAGE BODY admin_data AS
  PROCEDURE open_cv (generic_cv IN OUT gencurtyp, choice INT) IS
  BEGIN
    IF choice = 1 THEN
```

```
        OPEN generic_cv FOR SELECT * FROM employees;
    ELSIF choice = 2 THEN
        OPEN generic_cv FOR SELECT * FROM departments;
    ELSIF choice = 3 THEN
        OPEN generic_cv FOR SELECT * FROM jobs;
    END IF;
END;
END admin_data;
/
```

6.4.9 Cursor Variables as Host Variables

You can use a cursor variable as a host variable, which makes it useful for passing query results between PL/SQL stored subprograms and their clients.

When a cursor variable is a host variable, PL/SQL and the client (the host environment) share a pointer to the SQL work area that stores the result set.

To use a cursor variable as a host variable, declare the cursor variable in the host environment and then pass it as an input host variable (bind variable) to PL/SQL. Host cursor variables are compatible with any query return type (like weak PL/SQL cursor variables).

A SQL work area remains accessible while any cursor variable points to it, even if you pass the value of a cursor variable from one scope to another. For example, in [Example 6-34](#), the Pro*C program passes a host cursor variable to an embedded PL/SQL anonymous block. After the block runs, the cursor variable still points to the SQL work area.

If you have a PL/SQL engine on the client side, calls from client to server impose no restrictions. For example, you can declare a cursor variable on the client side, open and fetch from it on the server side, and continue to fetch from it on the client side. You can also reduce network traffic with a PL/SQL anonymous block that opens or closes several host cursor variables in a single round trip. For example:

```
/* PL/SQL anonymous block in host environment */
BEGIN
    OPEN :emp_cv FOR SELECT * FROM employees;
    OPEN :dept_cv FOR SELECT * FROM departments;
    OPEN :loc_cv FOR SELECT * FROM locations;
END;
/
```

Because the cursor variables still point to the SQL work areas after the PL/SQL anonymous block runs, the client program can use them. When the client program no longer needs the cursors, it can use a PL/SQL anonymous block to close them. For example:

```
/* PL/SQL anonymous block in host environment */
BEGIN
    CLOSE :emp_cv;
    CLOSE :dept_cv;
    CLOSE :loc_cv;
END;
/
```

This technique is useful for populating a multiblock form, as in Oracle Forms. For example, you can open several SQL work areas in a single round trip, like this:

```

/* PL/SQL anonymous block in host environment */
BEGIN
  OPEN :c1 FOR SELECT 1 FROM DUAL;
  OPEN :c2 FOR SELECT 1 FROM DUAL;
  OPEN :c3 FOR SELECT 1 FROM DUAL;
END;
/

```

Note:

If you bind a host cursor variable into PL/SQL from an Oracle Call Interface (OCI) client, then you cannot fetch from it on the server side unless you also open it there on the same server call.

Example 6-34 Cursor Variable as Host Variable in Pro*C Client Program

In this example, a Pro*C client program declares a cursor variable and a selector and passes them as host variables to a PL/SQL anonymous block, which opens the cursor variable for the selected query.

```

EXEC SQL BEGIN DECLARE SECTION;
  SQL_CURSOR generic_cv; -- Declare host cursor variable.
  int choice; -- Declare selector.
EXEC SQL END DECLARE SECTION;
EXEC SQL ALLOCATE :generic_cv; -- Initialize host cursor variable.
-- Pass host cursor variable and selector to PL/SQL block.
/
EXEC SQL EXECUTE
BEGIN
  IF :choice = 1 THEN
    OPEN :generic_cv FOR SELECT * FROM employees;
  ELSIF :choice = 2 THEN
    OPEN :generic_cv FOR SELECT * FROM departments;
  ELSIF :choice = 3 THEN
    OPEN :generic_cv FOR SELECT * FROM jobs;
  END IF;
END;
END-EXEC;

```

6.5 CURSOR Expressions

A CURSOR expression returns a nested cursor.

It has this syntax:

```
CURSOR ( subquery )
```

You can use a CURSOR expression in a SELECT statement that is not a subquery (as in [Example 6-35](#)) or pass it to a function that accepts a cursor variable parameter (see "[Passing CURSOR Expressions to Pipelined Table Functions](#)"). You cannot use a cursor expression with an implicit cursor.

 **See Also:**

Oracle Database SQL Language Reference for more information about CURSOR expressions, including restrictions

Example 6-35 CURSOR Expression

This example declares and defines an explicit cursor for a query that includes a cursor expression. For each department in the `departments` table, the nested cursor returns the last name of each employee in that department (which it retrieves from the `employees` table).

```

DECLARE
    TYPE emp_cur_typ IS REF CURSOR;

    emp_cur    emp_cur_typ;
    dept_name  departments.department_name%TYPE;
    emp_name   employees.last_name%TYPE;

    CURSOR c1 IS
        SELECT department_name,
               CURSOR ( SELECT e.last_name
                       FROM employees e
                       WHERE e.department_id = d.department_id
                       ORDER BY e.last_name
                       ) employees
        FROM departments d
        WHERE department_name LIKE 'A%'
        ORDER BY department_name;

BEGIN
    OPEN c1;
    LOOP -- Process each row of query result set
        FETCH c1 INTO dept_name, emp_cur;
        EXIT WHEN c1%NOTFOUND;
        DBMS_OUTPUT.PUT_LINE('Department: ' || dept_name);

        LOOP -- Process each row of subquery result set
            FETCH emp_cur INTO emp_name;
            EXIT WHEN emp_cur%NOTFOUND;
            DBMS_OUTPUT.PUT_LINE('-- Employee: ' || emp_name);
        END LOOP;
    END LOOP;
    CLOSE c1;
END;
/

```

Result:

```

Department: Accounting
-- Employee: Gietz
-- Employee: Higgins
Department: Administration
-- Employee: Whalen

```

6.6 Transaction Processing and Control

Transaction processing is an Oracle Database feature that lets multiple users work on the database concurrently, and ensures that each user sees a consistent version of data and that all changes are applied in the right order.

A **transaction** is a sequence of one or more SQL statements that Oracle Database treats as a unit: either all of the statements are performed, or none of them are.

Different users can write to the same data structures without harming each other's data or coordinating with each other, because Oracle Database locks data structures automatically. To maximize data availability, Oracle Database locks the minimum amount of data for the minimum amount of time.

You rarely must write extra code to prevent problems with multiple users accessing data concurrently. However, if you do need this level of control, you can manually override the Oracle Database default locking mechanisms.

Topics

- [COMMIT Statement](#)
- [ROLLBACK Statement](#)
- [SAVEPOINT Statement](#)
- [Implicit Rollbacks](#)
- [SET TRANSACTION Statement](#)
- [Overriding Default Locking](#)

See Also:

- *Oracle Database Concepts* for more information about transactions
- *Oracle Database Concepts* for more information about transaction processing
- *Oracle Database Concepts* for more information about the Oracle Database locking mechanism
- *Oracle Database Concepts* for more information about manual data locks

6.6.1 COMMIT Statement

The `COMMIT` statement ends the current transaction, making its changes permanent and visible to other users.

Note:

A transaction can span multiple blocks, and a block can contain multiple transactions.

The `WRITE` clause of the `COMMIT` statement specifies the priority with which Oracle Database writes to the redo log the information that the commit operation generates.

 **Note:**

The default PL/SQL commit behavior for nondistributed transactions is `BATCH NOWAIT` if the `COMMIT_LOGGING` and `COMMIT_WAIT` database initialization parameters have not been set.

 **See Also:**

- *Oracle Database Concepts* for more information about committing transactions
- *Oracle Database Concepts* for information about distributed transactions
- *Oracle Database SQL Language Reference* for information about the `COMMIT` statement
- *Oracle Data Guard Concepts and Administration* for information about ensuring no loss of data during a failover to a standby database

Example 6-36 COMMIT Statement with COMMENT and WRITE Clauses

In this example, a transaction transfers money from one bank account to another. It is important that the money both leaves one account and enters the other, hence the `COMMIT WRITE IMMEDIATE NOWAIT` statement.

```
DROP TABLE accounts;
CREATE TABLE accounts (
  account_id NUMBER(6),
  balance     NUMBER (10,2)
);

INSERT INTO accounts (account_id, balance)
VALUES (7715, 6350.00);

INSERT INTO accounts (account_id, balance)
VALUES (7720, 5100.50);

CREATE OR REPLACE PROCEDURE transfer (
  from_acct NUMBER,
  to_acct   NUMBER,
  amount    NUMBER
) AUTHID CURRENT_USER AS
BEGIN
  UPDATE accounts
  SET balance = balance - amount
  WHERE account_id = from_acct;

  UPDATE accounts
  SET balance = balance + amount
  WHERE account_id = to_acct;
```

```

    COMMIT WRITE IMMEDIATE NOWAIT;
END;
/

```

Query before transfer:

```
SELECT * FROM accounts;
```

Result:

ACCOUNT_ID	BALANCE
7715	6350
7720	5100.5

```

BEGIN
    transfer(7715, 7720, 250);
END;
/

```

Query after transfer:

```
SELECT * FROM accounts;
```

Result:

ACCOUNT_ID	BALANCE
7715	6100
7720	5350.5

6.6.2 ROLLBACK Statement

The `ROLLBACK` statement ends the current transaction and undoes any changes made during that transaction.

If you make a mistake, such as deleting the wrong row from a table, a rollback restores the original data. If you cannot finish a transaction because a SQL statement fails or PL/SQL raises an exception, a rollback lets you take corrective action and perhaps start over.



See Also:

Oracle Database SQL Language Reference for more information about the `ROLLBACK` statement

Example 6-37 ROLLBACK Statement

This example inserts information about an employee into three different tables. If an `INSERT` statement tries to store a duplicate employee number, PL/SQL raises the predefined exception `DUP_VAL_ON_INDEX`. To ensure that changes to all three tables are undone, the exception handler runs a `ROLLBACK`.

```

DROP TABLE emp_name;
CREATE TABLE emp_name AS
    SELECT employee_id, last_name
    FROM employees;

```

```
CREATE UNIQUE INDEX empname_ix
ON emp_name (employee_id);

DROP TABLE emp_sal;
CREATE TABLE emp_sal AS
  SELECT employee_id, salary
  FROM employees;

CREATE UNIQUE INDEX empsal_ix
ON emp_sal (employee_id);

DROP TABLE emp_job;
CREATE TABLE emp_job AS
  SELECT employee_id, job_id
  FROM employees;

CREATE UNIQUE INDEX empjobid_ix
ON emp_job (employee_id);

DECLARE
  emp_id          NUMBER(6);
  emp_lastname   VARCHAR2(25);
  emp_salary     NUMBER(8,2);
  emp_jobid      VARCHAR2(10);
BEGIN
  SELECT employee_id, last_name, salary, job_id
  INTO emp_id, emp_lastname, emp_salary, emp_jobid
  FROM employees
  WHERE employee_id = 120;

  INSERT INTO emp_name (employee_id, last_name)
  VALUES (emp_id, emp_lastname);

  INSERT INTO emp_sal (employee_id, salary)
  VALUES (emp_id, emp_salary);

  INSERT INTO emp_job (employee_id, job_id)
  VALUES (emp_id, emp_jobid);

EXCEPTION
  WHEN DUP_VAL_ON_INDEX THEN
    ROLLBACK;
    DBMS_OUTPUT.PUT_LINE('Inserts were rolled back');
END;
/
```

6.6.3 SAVEPOINT Statement

The `SAVEPOINT` statement names and marks the current point in the processing of a transaction.

Savepoints let you roll back part of a transaction instead of the whole transaction. The number of active savepoints for each session is unlimited.

When you roll back to a savepoint, any savepoints marked after that savepoint are erased. The savepoint to which you roll back is not erased. A simple rollback or commit erases all savepoints.

If you mark a savepoint in a recursive subprogram, new instances of the `SAVEPOINT` statement run at each level in the recursive descent, but you can only roll back to the most recently marked savepoint.

Savepoint names are undeclared identifiers. Reusing a savepoint name in a transaction moves the savepoint from its old position to the current point in the transaction, which means that a rollback to the savepoint affects only the current part of the transaction.

See Also:

Oracle Database SQL Language Reference for more information about the `SET TRANSACTION SQL` statement

Example 6-38 `SAVEPOINT` and `ROLLBACK` Statements

This example marks a savepoint before doing an insert. If the `INSERT` statement tries to store a duplicate value in the `employee_id` column, PL/SQL raises the predefined exception `DUP_VAL_ON_INDEX` and the transaction rolls back to the savepoint, undoing only the `INSERT` statement.

```
DROP TABLE emp_name;
CREATE TABLE emp_name AS
  SELECT employee_id, last_name, salary
  FROM employees;

CREATE UNIQUE INDEX empname_ix
ON emp_name (employee_id);

DECLARE
  emp_id          employees.employee_id%TYPE;
  emp_lastname   employees.last_name%TYPE;
  emp_salary     employees.salary%TYPE;

BEGIN
  SELECT employee_id, last_name, salary
  INTO emp_id, emp_lastname, emp_salary
  FROM employees
  WHERE employee_id = 120;

  UPDATE emp_name
  SET salary = salary * 1.1
  WHERE employee_id = emp_id;

  DELETE FROM emp_name
  WHERE employee_id = 130;

  SAVEPOINT do_insert;

  INSERT INTO emp_name (employee_id, last_name, salary)
  VALUES (emp_id, emp_lastname, emp_salary);

EXCEPTION
  WHEN DUP_VAL_ON_INDEX THEN
```

```

        ROLLBACK TO do_insert;
    DBMS_OUTPUT.PUT_LINE('Insert was rolled back');
END;
/

```

Example 6-39 Reusing SAVEPOINT with ROLLBACK

```

DROP TABLE emp_name;
CREATE TABLE emp_name AS
    SELECT employee_id, last_name, salary
    FROM employees;

CREATE UNIQUE INDEX empname_ix
ON emp_name (employee_id);

DECLARE
    emp_id          employees.employee_id%TYPE;
    emp_lastname   employees.last_name%TYPE;
    emp_salary     employees.salary%TYPE;

BEGIN
    SELECT employee_id, last_name, salary
    INTO emp_id, emp_lastname, emp_salary
    FROM employees
    WHERE employee_id = 120;

    SAVEPOINT my_savepoint;

    UPDATE emp_name
    SET salary = salary * 1.1
    WHERE employee_id = emp_id;

    DELETE FROM emp_name
    WHERE employee_id = 130;

    SAVEPOINT my_savepoint;

    INSERT INTO emp_name (employee_id, last_name, salary)
    VALUES (emp_id, emp_lastname, emp_salary);

EXCEPTION
    WHEN DUP_VAL_ON_INDEX THEN
        ROLLBACK TO my_savepoint;
        DBMS_OUTPUT.PUT_LINE('Transaction rolled back. ');
END;
/

```

6.6.4 Implicit Rollbacks

Before running an `INSERT`, `UPDATE`, `DELETE`, or `MERGE` statement, the database marks an implicit savepoint (unavailable to you). If the statement fails, the database rolls back to the savepoint.

Usually, just the failed SQL statement is rolled back, not the whole transaction. If the statement raises an unhandled exception, the host environment determines what is rolled back.

The database can also roll back single SQL statements to break deadlocks. The database signals an error to a participating transaction and rolls back the current statement in that transaction.

Before running a SQL statement, the database must parse it, that is, examine it to ensure it follows syntax rules and refers to valid schema objects. Errors detected while running a SQL statement cause a rollback, but errors detected while parsing the statement do not.

If you exit a stored subprogram with an unhandled exception, PL/SQL does not assign values to `OUT` parameters, and does not do any rollback.

For information about handling exceptions, see [PL/SQL Error Handling](#)

6.6.5 SET TRANSACTION Statement

You use the `SET TRANSACTION` statement to begin a read-only or read-write transaction, establish an isolation level, or assign your current transaction to a specified rollback segment.

Read-only transactions are useful for running multiple queries while other users update the same tables.

During a read-only transaction, all queries refer to the same snapshot of the database, providing a multi-table, multi-query, read-consistent view. Other users can continue to query or update data as usual. A commit or rollback ends the transaction.

The `SET TRANSACTION` statement must be the first SQL statement in a read-only transaction and can appear only once in a transaction. If you set a transaction to `READ ONLY`, subsequent queries see only changes committed before the transaction began. The use of `READ ONLY` does not affect other users or transactions.

Only the `SELECT`, `OPEN`, `FETCH`, `CLOSE`, `LOCK TABLE`, `COMMIT`, and `ROLLBACK` statements are allowed in a read-only transaction. Queries cannot be `FOR UPDATE`.



See Also:

Oracle Database SQL Language Reference for more information about the SQL statement `SET TRANSACTION`

Example 6-40 SET TRANSACTION Statement in Read-Only Transaction

In this example, a read-only transaction gather order totals for the day, the past week, and the past month. The totals are unaffected by other users updating the database during the transaction. The `orders` table is in the sample schema `OE`.

```
DECLARE
  daily_order_total   NUMBER(12,2);
  weekly_order_total  NUMBER(12,2);
  monthly_order_total NUMBER(12,2);
BEGIN
  COMMIT; -- end previous transaction
  SET TRANSACTION READ ONLY NAME 'Calculate Order Totals';

  SELECT SUM (order_total)
  INTO daily_order_total
  FROM orders
  WHERE order_date = SYSDATE;

  SELECT SUM (order_total)
  INTO weekly_order_total
  FROM orders
```

```
WHERE order_date = SYSDATE - 7;

SELECT SUM (order_total)
INTO monthly_order_total
FROM orders
WHERE order_date = SYSDATE - 30;

COMMIT; -- ends read-only transaction
END;
/
```

6.6.6 Overriding Default Locking

By default, Oracle Database locks data structures automatically, which lets different applications write to the same data structures without harming each other's data or coordinating with each other.

If you must have exclusive access to data during a transaction, you can override default locking with these SQL statements:

- `LOCK TABLE`, which explicitly locks entire tables.
- `SELECT` with the `FOR UPDATE` clause (`SELECT FOR UPDATE`), which explicitly locks specific rows of a table.

Topics

- [LOCK TABLE Statement](#)
- [SELECT FOR UPDATE and FOR UPDATE Cursors](#)
- [Simulating CURRENT OF Clause with ROWID Pseudocolumn](#)

6.6.6.1 LOCK TABLE Statement

The `LOCK TABLE` statement explicitly locks one or more tables in a specified lock mode so that you can share or deny access to them.

The lock mode determines what other locks can be placed on the table. For example, many users can acquire row share locks on a table at the same time, but only one user at a time can acquire an exclusive lock. While one user has an exclusive lock on a table, no other users can insert, delete, or update rows in that table.

A table lock never prevents other users from querying a table, and a query never acquires a table lock. Only if two different transactions try to modify the same row does one transaction wait for the other to complete. The `LOCK TABLE` statement lets you specify how long to wait for another transaction to complete.

Table locks are released when the transaction that acquired them is either committed or rolled back.

 **See Also:**

- *Oracle Database Development Guide* for more information about locking tables explicitly
- *Oracle Database SQL Language Reference* for more information about the `LOCK TABLE` statement

6.6.6.2 SELECT FOR UPDATE and FOR UPDATE Cursors

The `SELECT` statement with the `FOR UPDATE` clause (`SELECT FOR UPDATE` statement) selects the rows of the result set and locks them. `SELECT FOR UPDATE` lets you base an update on the existing values in the rows, because it ensures that no other user can change those values before you update them. You can also use `SELECT FOR UPDATE` to lock rows that you do not want to update, as in [Example 9-6](#).

 **Note:**

In tables compressed with Hybrid Columnar Compression (HCC), DML statements lock compression units rather than rows. HCC, a feature of certain Oracle storage systems, is described in *Oracle Database Concepts*.

By default, the `SELECT FOR UPDATE` statement waits until the requested row lock is acquired. To change this behavior, use the `NOWAIT`, `WAIT`, or `SKIP LOCKED` clause of the `SELECT FOR UPDATE` statement. For information about these clauses, see *Oracle Database SQL Language Reference*.

When `SELECT FOR UPDATE` is associated with an explicit cursor, the cursor is called a **FOR UPDATE cursor**. Only a `FOR UPDATE` cursor can appear in the `CURRENT OF` clause of an `UPDATE` or `DELETE` statement. (The `CURRENT OF` clause, a PL/SQL extension to the `WHERE` clause of the SQL statements `UPDATE` and `DELETE`, restricts the statement to the current row of the cursor.)

When `SELECT FOR UPDATE` queries multiple tables, it locks only rows whose columns appear in the `FOR UPDATE` clause.

6.6.6.3 Simulating CURRENT OF Clause with ROWID Pseudocolumn

The rows of the result set are locked when you open a `FOR UPDATE` cursor, not as they are fetched. The rows are unlocked when you commit or roll back the transaction. After the rows are unlocked, you cannot fetch from the `FOR UPDATE` cursor, as [Example 6-41](#) shows (the result is the same if you substitute `ROLLBACK` for `COMMIT`).

The workaround is to simulate the `CURRENT OF` clause with the `ROWID` pseudocolumn (described in *Oracle Database SQL Language Reference*). Select the rowid of each row into a `UROWID` variable and use the rowid to identify the current row during subsequent updates and deletes, as in [Example 6-42](#). (To print the value of a `UROWID` variable, convert it to `VARCHAR2`, using the `ROWIDTOCHAR` function described in *Oracle Database SQL Language Reference*.)

 **Note:**

When you update a row in a table compressed with Hybrid Columnar Compression (HCC), the `ROWID` of the row changes. HCC, a feature of certain Oracle storage systems, is described in *Oracle Database Concepts*.

 **Caution:**

Because no `FOR UPDATE` clause locks the fetched rows, other users might unintentionally overwrite your changes.

 **Note:**

The extra space needed for read consistency is not released until the cursor is closed, which can slow down processing for large updates.

Example 6-41 FETCH with FOR UPDATE Cursor After COMMIT Statement

```
DROP TABLE emp;
CREATE TABLE emp AS SELECT * FROM employees;

DECLARE
  CURSOR c1 IS
    SELECT * FROM emp
      FOR UPDATE OF salary
    ORDER BY employee_id;

  emp_rec emp%ROWTYPE;
BEGIN
  OPEN c1;
  LOOP
    FETCH c1 INTO emp_rec; -- fails on second iteration
    EXIT WHEN c1%NOTFOUND;
    DBMS_OUTPUT.PUT_LINE (
      'emp_rec.employee_id = ' ||
      TO_CHAR(emp_rec.employee_id)
    );

    UPDATE emp
      SET salary = salary * 1.05
      WHERE employee_id = 105;

    COMMIT; -- releases locks
  END LOOP;
END;
/
```

Result:

```
emp_rec.employee_id = 100
DECLARE
```

```
*  
ERROR at line 1:  
ORA-01002: fetch out of sequence  
ORA-06512: at line 11
```

Example 6-42 Simulating CURRENT OF Clause with ROWID Pseudocolumn

```
DROP TABLE emp;  
CREATE TABLE emp AS SELECT * FROM employees;  
  
DECLARE  
  CURSOR c1 IS  
    SELECT last_name, job_id, rowid  
    FROM emp; -- no FOR UPDATE clause  
  
  my_lastname employees.last_name%TYPE;  
  my_jobid employees.job_id%TYPE;  
  my_rowid UROWID;  
BEGIN  
  OPEN c1;  
  LOOP  
    FETCH c1 INTO my_lastname, my_jobid, my_rowid;  
    EXIT WHEN c1%NOTFOUND;  
  
    UPDATE emp  
    SET salary = salary * 1.02  
    WHERE rowid = my_rowid; -- simulates WHERE CURRENT OF c1  
  
    COMMIT;  
  END LOOP;  
  CLOSE c1;  
END;  
/
```

6.7 Autonomous Transactions

An **autonomous transaction** is an independent transaction started by another transaction, the main transaction.

Autonomous transactions do SQL operations and commit or roll back, without committing or rolling back the main transaction.

Figure 6-1 shows how control flows from the main transaction (MT) to an autonomous routine (`proc2`) and back again. The autonomous routine commits two autonomous transactions (AT1 and AT2).

Figure 6-1 Transaction Control Flow

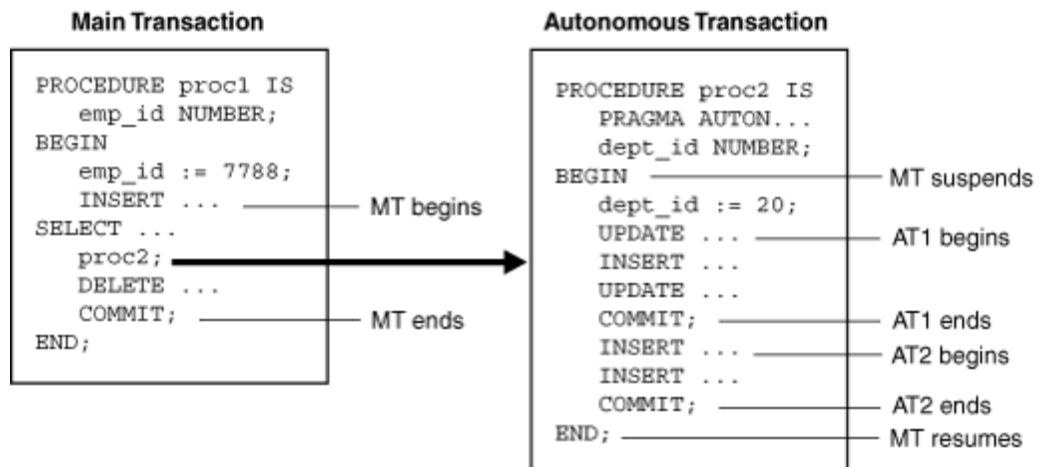
**Note:**

Although an autonomous transaction is started by another transaction, it is not a nested transaction, because:

- It does not share transactional resources (such as locks) with the main transaction.
- It does not depend on the main transaction.

For example, if the main transaction rolls back, nested transactions roll back, but autonomous transactions do not.

- Its committed changes are visible to other transactions immediately.

A nested transaction's committed changes are not visible to other transactions until the main transaction commits.

- Exceptions raised in an autonomous transaction cause a transaction-level rollback, not a statement-level rollback.

Topics

- [Advantages of Autonomous Transactions](#)
- [Transaction Context](#)
- [Transaction Visibility](#)
- [Declaring Autonomous Routines](#)
- [Controlling Autonomous Transactions](#)
- [Autonomous Triggers](#)
- [Invoking Autonomous Functions from SQL](#)

**See Also:**

Oracle Database Development Guide for more information about autonomous transactions

6.7.1 Advantages of Autonomous Transactions

After starting, an autonomous transaction is fully independent. It shares no locks, resources, or commit-dependencies with the main transaction. You can log events, increment retry counters, and so on, even if the main transaction rolls back.

Autonomous transactions help you build modular, reusable software components. You can encapsulate autonomous transactions in stored subprograms. An invoking application needs not know whether operations done by that stored subprogram succeeded or failed.

6.7.2 Transaction Context

The main transaction shares its context with nested routines, but not with autonomous transactions. When one autonomous routine invokes another (or itself, recursively), the routines share no transaction context. When an autonomous routine invokes a nonautonomous routine, the routines share the same transaction context.

6.7.3 Transaction Visibility

Changes made by an autonomous transaction become visible to other transactions when the autonomous transaction commits. These changes become visible to the main transaction when it resumes, if its isolation level is set to `READ COMMITTED` (the default).

If you set the isolation level of the main transaction to `SERIALIZABLE`, changes made by its autonomous transactions are *not* visible to the main transaction when it resumes:

```
SET TRANSACTION ISOLATION LEVEL SERIALIZABLE;
```

**Note:**

- Transaction properties apply only to the transaction in which they are set.
- Cursor attributes are not affected by autonomous transactions.

6.7.4 Declaring Autonomous Routines

To declare an autonomous routine, use the `AUTONOMOUS_TRANSACTION` pragma.

For information about this pragma, see "[AUTONOMOUS_TRANSACTION Pragma](#)".

**Tip:**

For readability, put the `AUTONOMOUS_TRANSACTION` pragma at the top of the declarative section. (The pragma is allowed anywhere in the declarative section.)

You cannot apply the `AUTONOMOUS_TRANSACTION` pragma to an entire package or ADT, but you can apply it to each subprogram in a package or each method of an ADT.

Example 6-43 Declaring Autonomous Function in Package

This example marks a package function as autonomous.

```
CREATE OR REPLACE PACKAGE emp_actions AUTHID DEFINER AS -- package specification
    FUNCTION raise_salary (emp_id NUMBER, sal_raise NUMBER)
        RETURN NUMBER;
END emp_actions;
/
CREATE OR REPLACE PACKAGE BODY emp_actions AS -- package body
    -- code for function raise_salary
    FUNCTION raise_salary (emp_id NUMBER, sal_raise NUMBER)
        RETURN NUMBER IS
        PRAGMA AUTONOMOUS_TRANSACTION;
        new_sal NUMBER(8,2);
    BEGIN
        UPDATE employees SET salary =
            salary + sal_raise WHERE employee_id = emp_id;
        COMMIT;
        SELECT salary INTO new_sal FROM employees
            WHERE employee_id = emp_id;
        RETURN new_sal;
    END raise_salary;
END emp_actions;
/
```

Example 6-44 Declaring Autonomous Standalone Procedure

This example marks a standalone subprogram as autonomous.

```
CREATE OR REPLACE PROCEDURE lower_salary
    (emp_id NUMBER, amount NUMBER)
AUTHID DEFINER AS
    PRAGMA AUTONOMOUS_TRANSACTION;
BEGIN
    UPDATE employees
    SET salary = salary - amount
    WHERE employee_id = emp_id;

    COMMIT;
END lower_salary;
/
```

Example 6-45 Declaring Autonomous PL/SQL Block

This example marks a schema-level PL/SQL block as autonomous. (A nested PL/SQL block cannot be autonomous.)

```
DROP TABLE emp;
CREATE TABLE emp AS SELECT * FROM employees;

DECLARE
    PRAGMA AUTONOMOUS_TRANSACTION;
    emp_id NUMBER(6) := 200;
    amount NUMBER(6,2) := 200;
BEGIN
    UPDATE employees
    SET salary = salary - amount
    WHERE employee_id = emp_id;

    COMMIT;
END;
/
```

6.7.5 Controlling Autonomous Transactions

The first SQL statement in an autonomous routine begins a transaction. When one transaction ends, the next SQL statement begins another transaction. All SQL statements run since the last commit or rollback comprise the current transaction. To control autonomous transactions, use these statements, which apply only to the current (active) transaction:

- COMMIT
- ROLLBACK [TO *savepoint_name*]
- SAVEPOINT *savepoint_name*
- SET TRANSACTION

Topics

- [Entering and Exiting Autonomous Routines](#)
- [Committing and Rolling Back Autonomous Transactions](#)
- [Savepoints](#)
- [Avoiding Errors with Autonomous Transactions](#)

6.7.5.1 Entering and Exiting Autonomous Routines

When you enter the executable section of an autonomous routine, the main transaction suspends. When you exit the routine, the main transaction resumes.

If you try to exit an active autonomous transaction without committing or rolling back, the database raises an exception. If the exception is unhandled, or if the transaction ends because of some other unhandled exception, then the transaction rolls back.

To exit normally, the routine must explicitly commit or roll back all autonomous transactions. If the routine (or any routine invoked by it) has pending transactions, then PL/SQL raises an exception and the pending transactions roll back.

6.7.5.2 Committing and Rolling Back Autonomous Transactions

COMMIT and ROLLBACK end the active autonomous transaction but do not exit the autonomous routine. When one transaction ends, the next SQL statement begins another transaction. A single autonomous routine can contain several autonomous transactions, if it issues several COMMIT statements.

6.7.5.3 Savepoints

The scope of a savepoint is the transaction in which it is defined. Savepoints defined in the main transaction are unrelated to savepoints defined in its autonomous transactions. In fact, the main transaction and an autonomous transaction can use the same savepoint names.

You can roll back only to savepoints marked in the current transaction. In an autonomous transaction, you cannot roll back to a savepoint marked in the main transaction. To do so, you must resume the main transaction by exiting the autonomous routine.

When in the main transaction, rolling back to a savepoint marked before you started an autonomous transaction does *not* roll back the autonomous transaction. Remember, autonomous transactions are fully independent of the main transaction.

6.7.5.4 Avoiding Errors with Autonomous Transactions

To avoid some common errors, remember:

- If an autonomous transaction tries to access a resource held by the main transaction, a deadlock can occur. The database raises an exception in the autonomous transaction, which rolls back if the exception is unhandled.
- The database initialization parameter `TRANSACTIONS` specifies the maximum number of concurrent transactions. That number might be exceeded because an autonomous transaction runs concurrently with the main transaction.
- If you try to exit an active autonomous transaction without committing or rolling back, the database raises an exception. If the exception is unhandled, the transaction rolls back.
- You cannot run a `PIPE ROW` statement in an autonomous routine while an autonomous transaction is open. You must close the autonomous transaction before running the `PIPE ROW` statement. This is normally accomplished by committing or rolling back the autonomous transaction before running the `PIPE ROW` statement.

6.7.6 Autonomous Triggers

A trigger must be autonomous to run TCL or DDL statements.

To run DDL statements, the trigger must use native dynamic SQL.

See Also:

- [PL/SQL Triggers](#), for general information about triggers
- ["Description of Static SQL"](#) for general information about TCL statements
- *Oracle Database SQL Language Reference* for information about DDL statements
- ["Native Dynamic SQL"](#) for information about native dynamic SQL

One use of triggers is to log events transparently—for example, to log all inserts into a table, even those that roll back.

Example 6-46 Autonomous Trigger Logs INSERT Statements

In this example, whenever a row is inserted into the `EMPLOYEES` table, a trigger inserts the same row into a log table. Because the trigger is autonomous, it can commit changes to the log table regardless of whether they are committed to the main table.

```
DROP TABLE emp;
CREATE TABLE emp AS SELECT * FROM employees;

-- Log table:

DROP TABLE log;
CREATE TABLE log (
  log_id NUMBER(6),
  up_date DATE,
  new_sal NUMBER(8,2),
  old_sal NUMBER(8,2)
);

-- Autonomous trigger on emp table:

CREATE OR REPLACE TRIGGER log_sal
  BEFORE UPDATE OF salary ON emp FOR EACH ROW
DECLARE
  PRAGMA AUTONOMOUS_TRANSACTION;
BEGIN
  INSERT INTO log (
    log_id,
    up_date,
    new_sal,
    old_sal
  )
  VALUES (
    :old.employee_id,
    SYSDATE,
    :new.salary,
    :old.salary
  );
  COMMIT;
END;
/
UPDATE emp
SET salary = salary * 1.05
WHERE employee_id = 115;

COMMIT;

UPDATE emp
SET salary = salary * 1.05
WHERE employee_id = 116;

ROLLBACK;

-- Show that both committed and rolled-back updates
-- add rows to log table

SELECT * FROM log
WHERE log_id = 115 OR log_id = 116;
```

Result:

LOG_ID	UP_DATE	NEW_SAL	OLD_SAL
115	02-OCT-12	3255	3100
116	02-OCT-12	3045	2900

2 rows selected.

Example 6-47 Autonomous Trigger Uses Native Dynamic SQL for DDL

In this example, an autonomous trigger uses native dynamic SQL (an `EXECUTE IMMEDIATE` statement) to drop a temporary table after a row is inserted into the table `log`.

```
DROP TABLE temp;
CREATE TABLE temp (
  temp_id NUMBER(6),
  up_date DATE
);

CREATE OR REPLACE TRIGGER drop_temp_table
  AFTER INSERT ON log
DECLARE
  PRAGMA AUTONOMOUS_TRANSACTION;
BEGIN
  EXECUTE IMMEDIATE 'DROP TABLE temp';
  COMMIT;
END;
/
-- Show how trigger works
SELECT * FROM temp;
```

Result:

no rows selected

```
INSERT INTO log (log_id, up_date, new_sal, old_sal)
VALUES (999, SYSDATE, 5000, 4500);
```

1 row created.

```
SELECT * FROM temp;
```

Result:

```
SELECT * FROM temp
      *
ERROR at line 1:
ORA-00942: table or view does not exist
```

6.7.7 Invoking Autonomous Functions from SQL

A function invoked from SQL statements must obey rules meant to control side effects.

By definition, an autonomous routine never reads or writes database state (that is, it neither queries nor modifies any database table).

**See Also:**

"[Subprogram Side Effects](#)" for more information

Example 6-48 Invoking Autonomous Function

The package function `log_msg` is autonomous. Therefore, when the query invokes the function, the function inserts a message into database table `debug_output` without violating the rule against writing database state (modifying database tables).

```
DROP TABLE debug_output;
CREATE TABLE debug_output (message VARCHAR2(200));

CREATE OR REPLACE PACKAGE debugging AUTHID DEFINER AS
    FUNCTION log_msg (msg VARCHAR2) RETURN VARCHAR2;
END debugging;
/
CREATE OR REPLACE PACKAGE BODY debugging AS
    FUNCTION log_msg (msg VARCHAR2) RETURN VARCHAR2 IS
        PRAGMA AUTONOMOUS_TRANSACTION;
    BEGIN
        INSERT INTO debug_output (message) VALUES (msg);
        COMMIT;
        RETURN msg;
    END;
END debugging;
/
-- Invoke package function from query
DECLARE
    my_emp_id    NUMBER(6);
    my_last_name VARCHAR2(25);
    my_count     NUMBER;
BEGIN
    my_emp_id := 120;

    SELECT debugging.log_msg(last_name)
    INTO my_last_name
    FROM employees
    WHERE employee_id = my_emp_id;

    /* Even if you roll back in this scope,
       the insert into 'debug_output' remains committed,
       because it is part of an autonomous transaction. */

    ROLLBACK;
END;
/
```

7

PL/SQL Dynamic SQL

Dynamic SQL is a programming methodology for generating and running SQL statements at run time.

It is useful when writing general-purpose and flexible programs like ad hoc query systems, when writing programs that must run database definition language (DDL) statements, or when you do not know at compile time the full text of a SQL statement or the number or data types of its input and output variables.

PL/SQL provides two ways to write dynamic SQL:

- Native dynamic SQL, a PL/SQL language (that is, native) feature for building and running dynamic SQL statements
- `DBMS_SQL` package, an API for building, running, and describing dynamic SQL statements

Native dynamic SQL code is easier to read and write than equivalent code that uses the `DBMS_SQL` package, and runs noticeably faster (especially when it can be optimized by the compiler). However, to write native dynamic SQL code, you must know at compile time the number and data types of the input and output variables of the dynamic SQL statement. If you do not know this information at compile time, you must use the `DBMS_SQL` package. You must also use the `DBMS_SQL` package if you want a stored subprogram to return a query result implicitly (not through an `OUT REF CURSOR` parameter).

When you need both the `DBMS_SQL` package and native dynamic SQL, you can switch between them, using the "[DBMS_SQL.TO_REFCURSOR Function](#)" and "[DBMS_SQL.TO_CURSOR_NUMBER Function](#)".

Topics

- [When You Need Dynamic SQL](#)
- [Native Dynamic SQL](#)
- [DBMS_SQL Package](#)
- [SQL Injection](#)

7.1 When You Need Dynamic SQL

In PL/SQL, you need dynamic SQL to run:

- SQL whose text is unknown at compile time

For example, a `SELECT` statement that includes an identifier that is unknown at compile time (such as a table name) or a `WHERE` clause in which the number of subclauses is unknown at compile time.

- SQL that is not supported as static SQL

That is, any SQL construct not included in "[Description of Static SQL](#)".

If you do not need dynamic SQL, use static SQL, which has these advantages:

- Successful compilation verifies that static SQL statements reference valid database objects and that the necessary privileges are in place to access those objects.
- Successful compilation creates schema object dependencies.

For information about schema object dependencies, see *Oracle Database Development Guide*.

For information about using static SQL statements with PL/SQL, see [PL/SQL Static SQL](#).

7.2 Native Dynamic SQL

Native dynamic SQL processes most dynamic SQL statements with the `EXECUTE IMMEDIATE` statement.

If the dynamic SQL statement is a `SELECT` statement that returns multiple rows, native dynamic SQL gives you these choices:

- Use the `EXECUTE IMMEDIATE` statement with the `BULK COLLECT INTO` clause.
- Use the `OPEN FOR`, `FETCH`, and `CLOSE` statements.

The SQL cursor attributes work the same way after native dynamic SQL `INSERT`, `UPDATE`, `DELETE`, `MERGE`, and single-row `SELECT` statements as they do for their static SQL counterparts. For more information about SQL cursor attributes, see "[Cursors Overview](#)".

Topics

- [EXECUTE IMMEDIATE Statement](#)
- [OPEN FOR, FETCH, and CLOSE Statements](#)
- [Repeated Placeholder Names in Dynamic SQL Statements](#)

7.2.1 EXECUTE IMMEDIATE Statement

The `EXECUTE IMMEDIATE` statement is the means by which native dynamic SQL processes most dynamic SQL statements.

If the dynamic SQL statement is **self-contained** (that is, if it has no placeholders for bind variables and the only result that it can possibly return is an error), then the `EXECUTE IMMEDIATE` statement needs no clauses.

If the dynamic SQL statement includes placeholders for bind variables, each placeholder must have a corresponding bind variable in the appropriate clause of the `EXECUTE IMMEDIATE` statement, as follows:

- If the dynamic SQL statement is a `SELECT` statement that can return at most one row, put out-bind variables (defines) in the `INTO` clause and in-bind variables in the `USING` clause.
- If the dynamic SQL statement is a `SELECT` statement that can return multiple rows, put out-bind variables (defines) in the `BULK COLLECT INTO` clause and in-bind variables in the `USING` clause.

- If the dynamic SQL statement is a DML statement without a `RETURNING INTO` clause, other than `SELECT`, put all bind variables in the `USING` clause.
- If the dynamic SQL statement is a DML statement with a `RETURNING INTO` clause, put in-bind variables in the `USING` clause and out-bind variables in the `RETURNING INTO` clause.
- If the dynamic SQL statement is an anonymous PL/SQL block or a `CALL` statement, put all bind variables in the `USING` clause.

If the dynamic SQL statement invokes a subprogram, ensure that:

- The subprogram is either created at schema level or declared and defined in a package specification.
- Every bind variable that corresponds to a placeholder for a subprogram parameter has the same parameter mode as that subprogram parameter and a data type that is compatible with that of the subprogram parameter.
- No bind variable is the reserved word `NULL`.

To work around this restriction, use an uninitialized variable where you want to use `NULL`, as in [Example 7-7](#).

- No bind variable has a data type that SQL does not support (such as associative array indexed by string).

If the data type is a collection or record type, then it must be declared in a package specification.



Note:

Bind variables can be evaluated in any order. If a program determines order of evaluation, then at the point where the program does so, its behavior is undefined.

In [Example 7-4](#), [Example 7-5](#), and [Example 7-6](#), the dynamic PL/SQL block is an anonymous PL/SQL block that invokes a subprogram that has a formal parameter of a PL/SQL collection type. Collection types are not SQL data types. In each example, the collection type is declared in a package specification, and the subprogram is declared in the package specification and defined in the package body.

 **See Also:**

- ["CREATE FUNCTION Statement"](#) for information about creating functions at schema level
- ["CREATE PROCEDURE Statement"](#) for information about creating procedures at schema level
- ["PL/SQL Packages"](#) for information about packages
- ["CREATE PACKAGE Statement"](#) for information about declaring subprograms in packages
- ["CREATE PACKAGE BODY Statement"](#) for information about declaring and defining subprograms in packages
- ["CREATE PACKAGE Statement"](#) for more information about declaring types in a package specification
- ["EXECUTE IMMEDIATE Statement"](#) for syntax details of the EXECUTE IMMEDIATE statement
- ["PL/SQL Collections and Records"](#) for information about collection types

Example 7-1 Invoking Subprogram from Dynamic PL/SQL Block

In this example, the dynamic PL/SQL block is an anonymous PL/SQL block that invokes a subprogram created at schema level.

```
-- Subprogram that dynamic PL/SQL block invokes:
CREATE OR REPLACE PROCEDURE create_dept (
  deptid IN OUT NUMBER,
  dname  IN   VARCHAR2,
  mgrid  IN   NUMBER,
  locid  IN   NUMBER
) AUTHID DEFINER AS
BEGIN
  deptid := departments_seq.NEXTVAL;

  INSERT INTO departments (
    department_id,
    department_name,
    manager_id,
    location_id
  )
  VALUES (deptid, dname, mgrid, locid);
END;
/
DECLARE
  plsqli_block VARCHAR2(500);
  new_deptid   NUMBER(4);
  new_dname    VARCHAR2(30) := 'Advertising';
  new_mgrid    NUMBER(6)    := 200;
  new_locid    NUMBER(4)    := 1700;
BEGIN
  -- Dynamic PL/SQL block invokes subprogram:
  plsqli_block := 'BEGIN create_dept(:a, :b, :c, :d); END;';

  /* Specify bind variables in USING clause.
```

```

Specify mode for first parameter.
Modes of other parameters are correct by default. */

EXECUTE IMMEDIATE plsqli_block
  USING IN OUT new_deptid, new_dname, new_mgrid, new_locid;
END;
/

```

Example 7-2 Dynamically Invoking Subprogram with BOOLEAN Formal Parameter

In this example, the dynamic PL/SQL block is an anonymous PL/SQL block that invokes a subprogram that has a formal parameter of the PL/SQL (but not SQL) data type `BOOLEAN`.

```

CREATE OR REPLACE PROCEDURE p (x BOOLEAN) AUTHID DEFINER AS
BEGIN
  IF x THEN
    DBMS_OUTPUT.PUT_LINE('x is true');
  END IF;
END;
/

DECLARE
  dyn_stmt VARCHAR2(200);
  b BOOLEAN := TRUE;
BEGIN
  dyn_stmt := 'BEGIN p(:x); END;';
  EXECUTE IMMEDIATE dyn_stmt USING b;
END;
/

```

Result:

```
x is true
```

Example 7-3 Dynamically Invoking Subprogram with RECORD Formal Parameter

In this example, the dynamic PL/SQL block is an anonymous PL/SQL block that invokes a subprogram that has a formal parameter of the PL/SQL (but not SQL) data type `RECORD`. The record type is declared in a package specification, and the subprogram is declared in the package specification and defined in the package body.

```

CREATE OR REPLACE PACKAGE pkg AUTHID DEFINER AS

  TYPE rec IS RECORD (n1 NUMBER, n2 NUMBER);

  PROCEDURE p (x OUT rec, y NUMBER, z NUMBER);
END pkg;
/

CREATE OR REPLACE PACKAGE BODY pkg AS

  PROCEDURE p (x OUT rec, y NUMBER, z NUMBER) AS
  BEGIN
    x.n1 := y;
    x.n2 := z;
  END p;
END pkg;
/

DECLARE
  r pkg.rec;
  dyn_str VARCHAR2(3000);
BEGIN

```



```

dyn_str := 'BEGIN pkg.p(:x, 6, 8); END;';

EXECUTE IMMEDIATE dyn_str USING OUT r;

DBMS_OUTPUT.PUT_LINE('r.n1 = ' || r.n1);
DBMS_OUTPUT.PUT_LINE('r.n2 = ' || r.n2);
END;
/

```

Example 7-4 Dynamically Invoking Subprogram with Assoc. Array Formal Parameter

In this example, the dynamic PL/SQL block is an anonymous PL/SQL block that invokes a subprogram that has a formal parameter of the PL/SQL collection type associative array indexed by `PLS_INTEGER`.



Note:

An associative array type used in this context must be indexed by `PLS_INTEGER`.

```

CREATE OR REPLACE PACKAGE pkg AUTHID DEFINER AS

    TYPE number_names IS TABLE OF VARCHAR2(5)
        INDEX BY PLS_INTEGER;

    PROCEDURE print_number_names (x number_names);
END pkg;
/
CREATE OR REPLACE PACKAGE BODY pkg AS
    PROCEDURE print_number_names (x number_names) IS
    BEGIN
        FOR i IN x.FIRST .. x.LAST LOOP
            DBMS_OUTPUT.PUT_LINE(x(i));
        END LOOP;
    END;
END pkg;
/
DECLARE
    digit_names pkg.number_names;
    dyn_stmt    VARCHAR2(3000);
BEGIN
    digit_names(0) := 'zero';
    digit_names(1) := 'one';
    digit_names(2) := 'two';
    digit_names(3) := 'three';
    digit_names(4) := 'four';
    digit_names(5) := 'five';
    digit_names(6) := 'six';
    digit_names(7) := 'seven';
    digit_names(8) := 'eight';
    digit_names(9) := 'nine';

    dyn_stmt := 'BEGIN pkg.print_number_names(:x); END;';
    EXECUTE IMMEDIATE dyn_stmt USING digit_names;
END;
/

```

Example 7-5 Dynamically Invoking Subprogram with Nested Table Formal Parameter

In this example, the dynamic PL/SQL block is an anonymous PL/SQL block that invokes a subprogram that has a formal parameter of the PL/SQL collection type nested table.

```
CREATE OR REPLACE PACKAGE pkg AUTHID DEFINER AS

    TYPE names IS TABLE OF VARCHAR2(10);

    PROCEDURE print_names (x names);
END pkg;
/
CREATE OR REPLACE PACKAGE BODY pkg AS
    PROCEDURE print_names (x names) IS
    BEGIN
        FOR i IN x.FIRST .. x.LAST LOOP
            DBMS_OUTPUT.PUT_LINE(x(i));
        END LOOP;
    END;
END pkg;
/
DECLARE
    fruits pkg.names;
    dyn_stmt VARCHAR2(3000);
BEGIN
    fruits := pkg.names('apple', 'banana', 'cherry');

    dyn_stmt := 'BEGIN pkg.print_names(:x); END;';
    EXECUTE IMMEDIATE dyn_stmt USING fruits;
END;
/
```

Example 7-6 Dynamically Invoking Subprogram with Varray Formal Parameter

In this example, the dynamic PL/SQL block is an anonymous PL/SQL block that invokes a subprogram that has a formal parameter of the PL/SQL collection type varray.

```
CREATE OR REPLACE PACKAGE pkg AUTHID DEFINER AS

    TYPE foursome IS VARRAY(4) OF VARCHAR2(5);

    PROCEDURE print_foursome (x foursome);
END pkg;
/
CREATE OR REPLACE PACKAGE BODY pkg AS
    PROCEDURE print_foursome (x foursome) IS
    BEGIN
        IF x.COUNT = 0 THEN
            DBMS_OUTPUT.PUT_LINE('Empty');
        ELSE
            FOR i IN x.FIRST .. x.LAST LOOP
                DBMS_OUTPUT.PUT_LINE(x(i));
            END LOOP;
        END IF;
    END;
END pkg;
/
DECLARE
    directions pkg.foursome;
    dyn_stmt VARCHAR2(3000);
BEGIN
    directions := pkg.foursome('north', 'south', 'east', 'west');
END;
```

```

dyn_stmt := 'BEGIN pkg.print_foursome(:x); END;';
EXECUTE IMMEDIATE dyn_stmt USING directions;
END;
/

```

Example 7-7 Uninitialized Variable Represents NULL in USING Clause

This example uses an uninitialized variable to represent the reserved word `NULL` in the `USING` clause.

```

CREATE TABLE employees_temp AS SELECT * FROM EMPLOYEES;

DECLARE
  a_null CHAR(1); -- Set to NULL automatically at run time
BEGIN
  EXECUTE IMMEDIATE 'UPDATE employees_temp SET commission_pct = :x'
    USING a_null;
END;
/

```

7.2.2 OPEN FOR, FETCH, and CLOSE Statements

If the dynamic SQL statement represents a `SELECT` statement that returns multiple rows, you can process it with native dynamic SQL as follows:

1. Use an `OPEN FOR` statement to associate a cursor variable with the dynamic SQL statement. In the `USING` clause of the `OPEN FOR` statement, specify a bind variable for each placeholder in the dynamic SQL statement.
The `USING` clause cannot contain the literal `NULL`. To work around this restriction, use an uninitialized variable where you want to use `NULL`, as in [Example 7-7](#).
2. Use the `FETCH` statement to retrieve result set rows one at a time, several at a time, or all at once.
3. Use the `CLOSE` statement to close the cursor variable.

The dynamic SQL statement can query a collection if the collection meets the criteria in ["Querying a Collection"](#).

See Also:

- ["OPEN FOR Statement"](#) for syntax details
- ["FETCH Statement"](#) for syntax details
- ["CLOSE Statement"](#) for syntax details

Example 7-8 Native Dynamic SQL with OPEN FOR, FETCH, and CLOSE Statements

This example lists all employees who are managers, retrieving result set rows one at a time.

```

DECLARE
  TYPE EmpCurTyp IS REF CURSOR;

```

```

v_emp_cursor    EmpCurTyp;
emp_record      employees%ROWTYPE;
v_stmt_str      VARCHAR2(200);
v_e_job         employees.job%TYPE;
BEGIN
  -- Dynamic SQL statement with placeholder:
  v_stmt_str := 'SELECT * FROM employees WHERE job_id = :j';

  -- Open cursor & specify bind variable in USING clause:
  OPEN v_emp_cursor FOR v_stmt_str USING 'MANAGER';

  -- Fetch rows from result set one at a time:
  LOOP
    FETCH v_emp_cursor INTO emp_record;
    EXIT WHEN v_emp_cursor%NOTFOUND;
  END LOOP;

  -- Close cursor:
  CLOSE v_emp_cursor;
END;
/

```

Example 7-9 Querying a Collection with Native Dynamic SQL

This example is like [Example 6-30](#) except that the collection variable `v1` is a bind variable.

```

CREATE OR REPLACE PACKAGE pkg AUTHID DEFINER AS
  TYPE rec IS RECORD(f1 NUMBER, f2 VARCHAR2(30));
  TYPE mytab IS TABLE OF rec INDEX BY pls_integer;
END;
/

DECLARE
  v1 pkg.mytab; -- collection of records
  v2 pkg.rec;
  c1 SYS_REFCURSOR;
BEGIN
  OPEN c1 FOR 'SELECT * FROM TABLE(:1)' USING v1;
  FETCH c1 INTO v2;
  CLOSE c1;
  DBMS_OUTPUT.PUT_LINE('Values in record are ' || v2.f1 || ' and ' || v2.f2);
END;
/

```

7.2.3 Repeated Placeholder Names in Dynamic SQL Statements

If you repeat placeholder names in dynamic SQL statements, be aware that the way placeholders are associated with bind variables depends on the kind of dynamic SQL statement.

Topics

- [Dynamic SQL Statement is Not Anonymous Block or CALL Statement](#)
- [Dynamic SQL Statement is Anonymous Block or CALL Statement](#)

7.2.3.1 Dynamic SQL Statement is Not Anonymous Block or CALL Statement

If the dynamic SQL statement does not represent an anonymous PL/SQL block or a `CALL` statement, repetition of placeholder names is insignificant.

Placeholders are associated with bind variables in the `USING` clause by position, not by name.

For example, in this dynamic SQL statement, the repetition of the name `:x` is insignificant:

```
sql_stmt := 'INSERT INTO payroll VALUES (:x, :x, :y, :x)';
```

In the corresponding `USING` clause, you must supply four bind variables. They can be different; for example:

```
EXECUTE IMMEDIATE sql_stmt USING a, b, c, d;
```

The preceding `EXECUTE IMMEDIATE` statement runs this SQL statement:

```
INSERT INTO payroll VALUES (a, b, c, d)
```

To associate the same bind variable with each occurrence of `:x`, you must repeat that bind variable; for example:

```
EXECUTE IMMEDIATE sql_stmt USING a, a, b, a;
```

The preceding `EXECUTE IMMEDIATE` statement runs this SQL statement:

```
INSERT INTO payroll VALUES (a, a, b, a)
```

7.2.3.2 Dynamic SQL Statement is Anonymous Block or CALL Statement

If the dynamic SQL statement represents an anonymous PL/SQL block or a `CALL` statement, repetition of placeholder names is significant.

Each unique placeholder name must have a corresponding bind variable in the `USING` clause. If you repeat a placeholder name, you need not repeat its corresponding bind variable. All references to that placeholder name correspond to one bind variable in the `USING` clause.

Example 7-10 Repeated Placeholder Names in Dynamic PL/SQL Block

In this example, all references to the first unique placeholder name, `:x`, are associated with the first bind variable in the `USING` clause, `a`, and the second unique placeholder name, `:y`, is associated with the second bind variable in the `USING` clause, `b`.

```
CREATE PROCEDURE calc_stats (
    w NUMBER,
    x NUMBER,
    y NUMBER,
    z NUMBER )
IS
BEGIN
    DBMS_OUTPUT.PUT_LINE(w + x + y + z);
END;
/
DECLARE
    a NUMBER := 4;
    b NUMBER := 7;
    plsqli_block VARCHAR2(100);
BEGIN
    plsqli_block := 'BEGIN calc_stats(:x, :x, :y, :x); END;';
    EXECUTE IMMEDIATE plsqli_block USING a, b; -- calc_stats(a, a, b, a)
```

```
END;  
/
```

7.3 DBMS_SQL Package

The DBMS_SQL package defines an entity called a SQL cursor number. Because the SQL cursor number is a PL/SQL integer, you can pass it across call boundaries and store it.

You must use the DBMS_SQL package to run a dynamic SQL statement if any of the following are true:

- You do not know the `SELECT` list until run time.
- You do not know until run time what placeholders in a `SELECT` or `DML` statement must be bound.
- You want a stored subprogram to return a query result implicitly (not through an `OUT REF CURSOR` parameter), which requires the `DBMS_SQL.RETURN_RESULT` procedure.

In these situations, you must use native dynamic SQL instead of the DBMS_SQL package:

- The dynamic SQL statement retrieves rows into records.
- You want to use the SQL cursor attribute `%FOUND`, `%ISOPEN`, `%NOTFOUND`, or `%ROWCOUNT` after issuing a dynamic SQL statement that is an `INSERT`, `UPDATE`, `DELETE`, `MERGE`, or single-row `SELECT` statement.

When you need both the DBMS_SQL package and native dynamic SQL, you can switch between them, using the functions `DBMS_SQL.TO_REFCURSOR` and `DBMS_SQL.TO_CURSOR_NUMBER`.

Topics

- [DBMS_SQL.RETURN_RESULT Procedure](#)
- [DBMS_SQL.GET_NEXT_RESULT Procedure](#)
- [DBMS_SQL.TO_REFCURSOR Function](#)
- [DBMS_SQL.TO_CURSOR_NUMBER Function](#)

Note:

You can invoke DBMS_SQL subprograms remotely.

See Also:

- ["Native Dynamic SQL"](#) for information about native dynamic SQL
- *Oracle Database PL/SQL Packages and Types Reference* for more information about the DBMS_SQL package, including instructions for running a dynamic SQL statement that has an unknown number of input or output variables ("Method 4")

7.3.1 DBMS_SQL.RETURN_RESULT Procedure

The `DBMS_SQL.RETURN_RESULT` procedure lets a stored subprogram return a query result implicitly to either the client program (which invokes the subprogram indirectly) or the immediate caller of the subprogram. After `DBMS_SQL.RETURN_RESULT` returns the result, only the recipient can access it.

The `DBMS_SQL.RETURN_RESULT` has two overloads:

```
PROCEDURE RETURN_RESULT (rc IN OUT SYS_REFCURSOR,  
                        to_client IN BOOLEAN DEFAULT TRUE);
```

```
PROCEDURE RETURN_RESULT (rc IN OUT INTEGER,  
                        to_client IN BOOLEAN DEFAULT TRUE);
```

The `rc` parameter is either an open cursor variable (`SYS_REFCURSOR`) or the cursor number (`INTEGER`) of an open cursor. To open a cursor and get its cursor number, invoke the `DBMS_SQL.OPEN_CURSOR` function, described in *Oracle Database PL/SQL Packages and Types Reference*.

When the `to_client` parameter is `TRUE` (the default), the `DBMS_SQL.RETURN_RESULT` procedure returns the query result to the client program (which invokes the subprogram indirectly); when this parameter is `FALSE`, the procedure returns the query result to the subprogram's immediate caller.

See Also:

- *Oracle Database PL/SQL Packages and Types Reference* for more information about `DBMS_SQL.RETURN_RESULT`
- *Oracle Call Interface Programmer's Guide* for information about C and .NET support for implicit query results
- *SQL*Plus User's Guide and Reference* for information about SQL*Plus support for implicit query results

Example 7-11 DBMS_SQL.RETURN_RESULT Procedure

In this example, the procedure `p` invokes `DBMS_SQL.RETURN_RESULT` without the optional `to_client` parameter (which is `TRUE` by default). Therefore, `DBMS_SQL.RETURN_RESULT` returns the query result to the subprogram client (the anonymous block that invokes `p`). After `p` returns a result to the anonymous block, only the anonymous block can access that result.

```
CREATE OR REPLACE PROCEDURE p AUTHID DEFINER AS  
  c1 SYS_REFCURSOR;  
  c2 SYS_REFCURSOR;  
BEGIN  
  OPEN c1 FOR  
    SELECT first_name, last_name  
    FROM employees  
    WHERE employee_id = 176;  
  
  DBMS_SQL.RETURN_RESULT (c1);
```

```

-- Now p cannot access the result.

OPEN c2 FOR
  SELECT city, state_province
  FROM locations
  WHERE country_id = 'AU';

DBMS_SQL.RETURN_RESULT (c2);
-- Now p cannot access the result.
END;
/
BEGIN
  p;
END;
/

```

Result:

ResultSet #1

FIRST_NAME	LAST_NAME
Jonathon	Taylor

ResultSet #2

CITY	STATE_PROVINCE
Sydney	New South Wales

7.3.2 DBMS_SQL.GET_NEXT_RESULT Procedure

The `DBMS_SQL.GET_NEXT_RESULT` procedure gets the next result that the `DBMS_SQL.RETURN_RESULT` procedure returned to the recipient. The two procedures return results in the same order.

The `DBMS_SQL.GET_NEXT_RESULT` has two overloads:

```
PROCEDURE GET_NEXT_RESULT (c IN INTEGER, rc OUT SYS_REFCURSOR);
```

```
PROCEDURE GET_NEXT_RESULT (c IN INTEGER, rc OUT INTEGER);
```

The `c` parameter is the cursor number of an open cursor that directly or indirectly invokes a subprogram that uses the `DBMS_SQL.RETURN_RESULT` procedure to return a query result implicitly.

To open a cursor and get its cursor number, invoke the `DBMS_SQL.OPEN_CURSOR` function. `DBMS_SQL.OPEN_CURSOR` has an optional parameter, `treat_as_client_for_results`. When this parameter is `FALSE` (the default), the caller that opens this cursor (to invoke a subprogram) is not treated as the client that receives query results for the client from the subprogram that uses `DBMS_SQL.RETURN_RESULT`—those query results are returned to the client in a upper tier instead. When this parameter is `TRUE`, the caller is treated as the client. For more information about the `DBMS_SQL.OPEN_CURSOR` function, see *Oracle Database PL/SQL Packages and Types Reference*.

The `rc` parameter is either a cursor variable (`SYS_REFCURSOR`) or the cursor number (`INTEGER`) of an open cursor.

In [Example 7-12](#), the procedure `get_employee_info` uses `DBMS_SQL.RETURN_RESULT` to return two query results to a client program and is invoked dynamically by the anonymous block `<<main>>`. Because `<<main>>` needs to receive the two query results that `get_employee_info` returns, `<<main>>` opens a cursor to invoke `get_employee_info` using `DBMS_SQL.OPEN_CURSOR` with the parameter `treat_as_client_for_results` set to `TRUE`. Therefore, `DBMS_SQL.GET_NEXT_RESULT` returns its results to `<<main>>`, which uses the cursor `rc` to fetch them.

Example 7-12 DBMS_SQL.GET_NEXT_RESULT Procedure

```
CREATE OR REPLACE PROCEDURE get_employee_info (id IN VARCHAR2) AUTHID DEFINER AS
  rc SYS_REFCURSOR;
BEGIN
  -- Return employee info

  OPEN rc FOR SELECT first_name, last_name, email, phone_number
              FROM employees
              WHERE employee_id = id;
  DBMS_SQL.RETURN_RESULT(rc);

  -- Return employee job history

  OPEN RC FOR SELECT job_title, start_date, end_date
              FROM job_history jh, jobs j
              WHERE jh.employee_id = id AND
                    jh.job_id = j.job_id
              ORDER BY start_date DESC;
  DBMS_SQL.RETURN_RESULT(rc);
END;
/
<<main>>
DECLARE
  c          INTEGER;
  rc         SYS_REFCURSOR;
  n         NUMBER;

  first_name VARCHAR2(20);
  last_name  VARCHAR2(25);
  email      VARCHAR2(25);
  phone_number VARCHAR2(20);

  job_title  VARCHAR2(35);
  start_date DATE;
  end_date   DATE;
BEGIN

  c := DBMS_SQL.OPEN_CURSOR(true);
  DBMS_SQL.PARSE(c, 'BEGIN get_employee_info(:id); END;', DBMS_SQL.NATIVE);
  DBMS_SQL.BIND_VARIABLE(c, ':id', 176);
  n := DBMS_SQL.EXECUTE(c);

  -- Get employee info

  dbms_sql.get_next_result(c, rc);
  FETCH rc INTO first_name, last_name, email, phone_number;

  DBMS_OUTPUT.PUT_LINE('Employee: ' || first_name || ' ' || last_name);
  DBMS_OUTPUT.PUT_LINE('Email: ' || email);
  DBMS_OUTPUT.PUT_LINE('Phone: ' || phone_number);
```

```

-- Get employee job history

DBMS_OUTPUT.PUT_LINE('Titles:');
DBMS_SQL.GET_NEXT_RESULT(c, rc);
LOOP
    FETCH rc INTO job_title, start_date, end_date;
    EXIT WHEN rc%NOTFOUND;
    DBMS_OUTPUT.PUT_LINE
        ('- '||job_title||' ('||start_date||' - ' ||end_date||)');
END LOOP;

DBMS_SQL.CLOSE_CURSOR(c);
END main;
/

```

Result:

```

Employee: Jonathon Taylor
Email: JTAYLOR
Phone: 011.44.1644.429265
Titles:
- Sales Manager (01-JAN-07 - 31-DEC-07)
- Sales Representative (24-MAR-06 - 31-DEC-06)

```

PL/SQL procedure successfully completed.

7.3.3 DBMS_SQL.TO_REFCURSOR Function

The `DBMS_SQL.TO_REFCURSOR` function converts a SQL cursor number to a weak cursor variable, which you can use in native dynamic SQL statements.

Before passing a SQL cursor number to the `DBMS_SQL.TO_REFCURSOR` function, you must `OPEN`, `PARSE`, and `EXECUTE` it (otherwise an error occurs).

After you convert a SQL cursor number to a `REF CURSOR` variable, `DBMS_SQL` operations can access it only as the `REF CURSOR` variable, not as the SQL cursor number. For example, using the `DBMS_SQL.IS_OPEN` function to see if a converted SQL cursor number is still open causes an error.

[Example 7-13](#) uses the `DBMS_SQL.TO_REFCURSOR` function to switch from the `DBMS_SQL` package to native dynamic SQL.

Example 7-13 Switching from DBMS_SQL Package to Native Dynamic SQL

```

CREATE OR REPLACE TYPE vc_array IS TABLE OF VARCHAR2(200);
/
CREATE OR REPLACE TYPE numlist IS TABLE OF NUMBER;
/
CREATE OR REPLACE PROCEDURE do_query_1 (
    placeholder vc_array,
    bindvars vc_array,
    sql_stmt VARCHAR2
) AUTHID DEFINER
IS
    TYPE curtype IS REF CURSOR;
    src_cur      curtype;
    curid        NUMBER;
    bindnames    vc_array;
    empnos       numlist;

```

```

depts      numlist;
ret        NUMBER;
isopen     BOOLEAN;
BEGIN
  -- Open SQL cursor number:
  curid := DBMS_SQL.OPEN_CURSOR;

  -- Parse SQL cursor number:
  DBMS_SQL.PARSE(curid, sql_stmt, DBMS_SQL.NATIVE);

  bindnames := placeholder;

  -- Bind variables:
  FOR i IN 1 .. bindnames.COUNT LOOP
    DBMS_SQL.BIND_VARIABLE(curid, bindnames(i), bindvars(i));
  END LOOP;

  -- Run SQL cursor number:
  ret := DBMS_SQL.EXECUTE(curid);

  -- Switch from DBMS_SQL to native dynamic SQL:
  src_cur := DBMS_SQL.TO_REFCURSOR(curid);
  FETCH src_cur BULK COLLECT INTO empnos, depts;

  -- This would cause an error because curid was converted to a REF CURSOR:
  -- isopen := DBMS_SQL.IS_OPEN(curid);

  CLOSE src_cur;
END;
/

```

7.3.4 DBMS_SQL.TO_CURSOR_NUMBER Function

The `DBMS_SQL.TO_CURSOR_NUMBER` function converts a `REF CURSOR` variable (either strong or weak) to a SQL cursor number, which you can pass to `DBMS_SQL` subprograms.

Before passing a `REF CURSOR` variable to the `DBMS_SQL.TO_CURSOR_NUMBER` function, you must `OPEN` it.

After you convert a `REF CURSOR` variable to a SQL cursor number, native dynamic SQL operations cannot access it.

[Example 7-14](#) uses the `DBMS_SQL.TO_CURSOR_NUMBER` function to switch from native dynamic SQL to the `DBMS_SQL` package.

Example 7-14 Switching from Native Dynamic SQL to DBMS_SQL Package

```

CREATE OR REPLACE PROCEDURE do_query_2 (
  sql_stmt VARCHAR2
) AUTHID DEFINER
IS
  TYPE curtype IS REF CURSOR;
  src_cur  curtype;
  curid    NUMBER;
  desctab  DBMS_SQL.DESC_TAB;
  colcnt   NUMBER;
  namevar  VARCHAR2(50);
  numvar   NUMBER;
  datevar  DATE;

```

```

empno      NUMBER := 100;
BEGIN
  -- sql_stmt := SELECT ... FROM employees WHERE employee_id = :b1';

  -- Open REF CURSOR variable:
  OPEN src_cur FOR sql_stmt USING empno;

  -- Switch from native dynamic SQL to DBMS_SQL package:
  curid := DBMS_SQL.TO_CURSOR_NUMBER(src_cur);
  DBMS_SQL.DESCRIBE_COLUMNS(curid, colcnt, desctab);

  -- Define columns:
  FOR i IN 1 .. colcnt LOOP
    IF desctab(i).col_type = 2 THEN
      DBMS_SQL.DEFINE_COLUMN(curid, i, numvar);
    ELSIF desctab(i).col_type = 12 THEN
      DBMS_SQL.DEFINE_COLUMN(curid, i, datevar);
      -- statements
    ELSE
      DBMS_SQL.DEFINE_COLUMN(curid, i, namevar, 50);
    END IF;
  END LOOP;

  -- Fetch rows with DBMS_SQL package:
  WHILE DBMS_SQL.FETCH_ROWS(curid) > 0 LOOP
    FOR i IN 1 .. colcnt LOOP
      IF (desctab(i).col_type = 1) THEN
        DBMS_SQL.COLUMN_VALUE(curid, i, namevar);
      ELSIF (desctab(i).col_type = 2) THEN
        DBMS_SQL.COLUMN_VALUE(curid, i, numvar);
      ELSIF (desctab(i).col_type = 12) THEN
        DBMS_SQL.COLUMN_VALUE(curid, i, datevar);
        -- statements
      END IF;
    END LOOP;
  END LOOP;

  DBMS_SQL.CLOSE_CURSOR(curid);
END;
/

```

7.4 SQL Injection

SQL injection maliciously exploits applications that use client-supplied data in SQL statements, thereby gaining unauthorized access to a database to view or manipulate restricted data.

This section describes SQL injection vulnerabilities in PL/SQL and explains how to guard against them.

Topics

- [SQL Injection Techniques](#)
- [Guards Against SQL Injection](#)

Example 7-15 Setup for SQL Injection Examples

To try the examples, run these statements.

 **Live SQL:**

You can view and run this example on Oracle Live SQL at [SQL Injection Demo](#)

```
DROP TABLE secret_records;
CREATE TABLE secret_records (
  user_name    VARCHAR2(9),
  service_type VARCHAR2(12),
  value        VARCHAR2(30),
  date_created DATE
);

INSERT INTO secret_records (
  user_name, service_type, value, date_created
)
VALUES ('Andy', 'Waiter', 'Serve dinner at Cafe Pete', SYSDATE);

INSERT INTO secret_records (
  user_name, service_type, value, date_created
)
VALUES ('Chuck', 'Merger', 'Buy company XYZ', SYSDATE);
```

7.4.1 SQL Injection Techniques

All SQL injection techniques exploit a single vulnerability: String input is not correctly validated and is concatenated into a dynamic SQL statement.

Topics

- [Statement Modification](#)
- [Statement Injection](#)
- [Data Type Conversion](#)

7.4.1.1 Statement Modification

Statement modification means deliberately altering a dynamic SQL statement so that it runs in a way unintended by the application developer.

Typically, the user retrieves unauthorized data by changing the `WHERE` clause of a `SELECT` statement or by inserting a `UNION ALL` clause. The classic example of this technique is bypassing password authentication by making a `WHERE` clause always `TRUE`.

Example 7-16 Procedure Vulnerable to Statement Modification

This example creates a procedure that is vulnerable to statement modification and then invokes that procedure with and without statement modification. With statement modification, the procedure returns a supposedly secret record.

 **Live SQL:**

You can view and run this example on Oracle Live SQL at [SQL Injection Demo](#)

Create vulnerable procedure:

```
CREATE OR REPLACE PROCEDURE get_record (
  user_name  IN VARCHAR2,
  service_type IN VARCHAR2,
  rec        OUT VARCHAR2
) AUTHID DEFINER
IS
  query VARCHAR2(4000);
BEGIN
  -- Following SELECT statement is vulnerable to modification
  -- because it uses concatenation to build WHERE clause.
  query := 'SELECT value FROM secret_records WHERE user_name='''
          || user_name
          || ''' AND service_type='''
          || service_type
          || ''';
  DBMS_OUTPUT.PUT_LINE('Query: ' || query);
  EXECUTE IMMEDIATE query INTO rec ;
  DBMS_OUTPUT.PUT_LINE('Rec: ' || rec );
END;
/
```

Demonstrate procedure without SQL injection:

```
SET SERVEROUTPUT ON;

DECLARE
  record_value VARCHAR2(4000);
BEGIN
  get_record('Andy', 'Waiter', record_value);
END;
/
```

Result:

```
Query: SELECT value FROM secret_records WHERE user_name='Andy' AND
service_type='Waiter'
Rec: Serve dinner at Cafe Pete
```

Example of statement modification:

```
DECLARE
  record_value VARCHAR2(4000);
BEGIN
  get_record(
    'Anybody ' || OR service_type='Merger' '--',
    'Anything',
    record_value);
END;
/
```

Result:

```
Query: SELECT value FROM secret_records WHERE user_name='Anybody ' OR
service_type='Merger'--' AND service_type='Anything'
Rec: Buy company XYZ
```

PL/SQL procedure successfully completed.

7.4.1.2 Statement Injection

Statement injection means that a user appends one or more SQL statements to a dynamic SQL statement.

Anonymous PL/SQL blocks are vulnerable to this technique.

Example 7-17 Procedure Vulnerable to Statement Injection

This example creates a procedure that is vulnerable to statement injection and then invokes that procedure with and without statement injection. With statement injection, the procedure deletes the supposedly secret record exposed in [Example 7-16](#).



Live SQL:

You can view and run this example on Oracle Live SQL at [SQL Injection Demo](#)

Create vulnerable procedure:

```
CREATE OR REPLACE PROCEDURE p (
  user_name  IN  VARCHAR2,
  service_type IN  VARCHAR2
) AUTHID DEFINER
IS
  block1 VARCHAR2(4000);
BEGIN
  -- Following block is vulnerable to statement injection
  -- because it is built by concatenation.
  block1 :=
    'BEGIN
    DBMS_OUTPUT.PUT_LINE('user_name: ' || user_name || ');'
    || 'DBMS_OUTPUT.PUT_LINE('service_type: ' || service_type || ');'
    END;';

  DBMS_OUTPUT.PUT_LINE('Block1: ' || block1);

  EXECUTE IMMEDIATE block1;
END;
/
```

Demonstrate procedure without SQL injection:

```
SET SERVEROUTPUT ON;

BEGIN
  p('Andy', 'Waiter');
END;
/
```

Result:

```
Block1: BEGIN
        DBMS_OUTPUT.PUT_LINE('user_name: Andy');
        DBMS_OUTPUT.PUT_LINE('service_type: Waiter');
    END;
user_name: Andy
service_type: Waiter
```

SQL*Plus formatting command:

```
COLUMN date_created FORMAT A12;
```

Query:

```
SELECT * FROM secret_records ORDER BY user_name;
```

Result:

USER_NAME	SERVICE_TYPE	VALUE	DATE_CREATED
Andy	Waiter	Serve dinner at Cafe Pete	28-APR-10
Chuck	Merger	Buy company XYZ	28-APR-10

Example of statement modification:

```
BEGIN
    p('Anybody', 'Anything');
    DELETE FROM secret_records WHERE service_type=INITCAP('Merger');
END;
/
```

Result:

```
Block1: BEGIN
        DBMS_OUTPUT.PUT_LINE('user_name: Anybody');
        DBMS_OUTPUT.PUT_LINE('service_type: Anything');
        DELETE FROM secret_records WHERE service_type=INITCAP('Merger');
    END;
user_name: Anybody
service_type: Anything
```

PL/SQL procedure successfully completed.

Query:

```
SELECT * FROM secret_records;
```

Result:

USER_NAME	SERVICE_TYPE	VALUE	DATE_CREATED
Andy	Waiter	Serve dinner at Cafe Pete	18-MAR-09

1 row selected.

7.4.1.3 Data Type Conversion

A less known SQL injection technique uses NLS session parameters to modify or inject SQL statements.

A datetime or numeric value that is concatenated into the text of a dynamic SQL statement must be converted to the `VARCHAR2` data type. The conversion can be either implicit (when the

value is an operand of the concatenation operator) or explicit (when the value is the argument of the `TO_CHAR` function). This data type conversion depends on the NLS settings of the database session that runs the dynamic SQL statement. The conversion of datetime values uses format models specified in the parameters `NLS_DATE_FORMAT`, `NLS_TIMESTAMP_FORMAT`, or `NLS_TIMESTAMP_TZ_FORMAT`, depending on the particular datetime data type. The conversion of numeric values applies decimal and group separators specified in the parameter `NLS_NUMERIC_CHARACTERS`.

One datetime format model is `"text"`. The `text` is copied into the conversion result. For example, if the value of `NLS_DATE_FORMAT` is `"Month:" Month'`, then in June, `TO_CHAR(SYSDATE)` returns `'Month: June'`. The datetime format model can be abused as shown in [Example 7-18](#).

Example 7-18 Procedure Vulnerable to SQL Injection Through Data Type Conversion

```
SELECT * FROM secret_records;
```

Result:

USER_NAME	SERVICE_TYPE	VALUE	DATE_CREATE
Andy	Waiter	Serve dinner at Cafe Pete	28-APR-2010
Chuck	Merger	Buy company XYZ	28-APR-2010

Create vulnerable procedure:

```
-- Return records not older than a month

CREATE OR REPLACE PROCEDURE get_recent_record (
  user_name  IN  VARCHAR2,
  service_type IN  VARCHAR2,
  rec        OUT VARCHAR2
) AUTHID DEFINER
IS
  query VARCHAR2(4000);
BEGIN
  /* Following SELECT statement is vulnerable to modification
  because it uses concatenation to build WHERE clause
  and because SYSDATE depends on the value of NLS_DATE_FORMAT. */

  query := 'SELECT value FROM secret_records WHERE user_name='''
          || user_name
          || ''' AND service_type='''
          || service_type
          || ''' AND date_created>'''
          || (SYSDATE - 30)
          || ''';

  DBMS_OUTPUT.PUT_LINE('Query: ' || query);
  EXECUTE IMMEDIATE query INTO rec;
  DBMS_OUTPUT.PUT_LINE('Rec: ' || rec);
END;
```

Demonstrate procedure without SQL injection:

```
SET SERVEROUTPUT ON;
ALTER SESSION SET NLS_DATE_FORMAT='DD-MON-YYYY';
```

```
DECLARE
    record_value VARCHAR2(4000);
BEGIN
    get_recent_record('Andy', 'Waiter', record_value);
END;
/
```

Result:

Query: SELECT value FROM secret_records WHERE user_name='Andy' AND service_type='Waiter' AND date_created>'29-MAR-2010'
Rec: Serve dinner at Cafe Pete

Example of statement modification:

```
ALTER SESSION SET NLS_DATE_FORMAT='' OR service_type='Merger'';
```

```
DECLARE
    record_value VARCHAR2(4000);
BEGIN
    get_recent_record('Anybody', 'Anything', record_value);
END;
/
```

Result:

Query: SELECT value FROM secret_records WHERE user_name='Anybody' AND service_type='Anything' AND date_created>' OR service_type='Merger'
Rec: Buy company XYZ

PL/SQL procedure successfully completed.

7.4.2 Guards Against SQL Injection

If you use dynamic SQL in your PL/SQL applications, you must check the input text to ensure that it is exactly what you expected.

You can use the following techniques:

- [Bind Variables](#)
- [Validation Checks](#)
- [Explicit Format Models](#)

7.4.2.1 Bind Variables

The most effective way to make your PL/SQL code invulnerable to SQL injection attacks is to use bind variables.

The database uses the values of bind variables exclusively and does not interpret their contents in any way. (Bind variables also improve performance.)

Example 7-19 Bind Variables Guarding Against SQL Injection

The procedure in this example is invulnerable to SQL injection because it builds the dynamic SQL statement with bind variables (not by concatenation as in the vulnerable procedure in [Example 7-16](#)). The same binding technique fixes the vulnerable procedure shown in [Example 7-17](#).

Create invulnerable procedure:

```
CREATE OR REPLACE PROCEDURE get_record_2 (
  user_name  IN  VARCHAR2,
  service_type IN VARCHAR2,
  rec        OUT VARCHAR2
) AUTHID DEFINER
IS
  query VARCHAR2(4000);
BEGIN
  query := 'SELECT value FROM secret_records
           WHERE user_name=:a
           AND service_type=:b';

  DBMS_OUTPUT.PUT_LINE('Query: ' || query);

  EXECUTE IMMEDIATE query INTO rec USING user_name, service_type;

  DBMS_OUTPUT.PUT_LINE('Rec: ' || rec);
END;
/
```

Demonstrate procedure without SQL injection:

```
SET SERVEROUTPUT ON;
DECLARE
  record_value VARCHAR2(4000);
BEGIN
  get_record_2('Andy', 'Waiter', record_value);
END;
/
```

Result:

```
Query: SELECT value FROM secret_records
       WHERE user_name=:a
       AND service_type=:b
Rec: Serve dinner at Cafe Pete
```

PL/SQL procedure successfully completed.

Try statement modification:

```
DECLARE
  record_value VARCHAR2(4000);
BEGIN
  get_record_2('Anybody ' || OR service_type='Merger'--,
              'Anything',
              record_value);
END;
/
```

Result:

```
Query: SELECT value FROM secret_records
       WHERE user_name=:a
       AND service_type=:b
```

```
DECLARE
*
```

ERROR at line 1:

```
ORA-01403: no data found
ORA-06512: at "HR.GET_RECORD_2", line 15
ORA-06512: at line 4
```

7.4.2.2 Validation Checks

Always have your program validate user input to ensure that it is what is intended.

For example, if the user is passing a department number for a `DELETE` statement, check the validity of this department number by selecting from the `departments` table. Similarly, if a user enters the name of a table to be deleted, check that this table exists by selecting from the static data dictionary view `ALL_TABLES`.

Caution:

When checking the validity of a user name and its password, always return the same error regardless of which item is invalid. Otherwise, a malicious user who receives the error message "invalid password" but not "invalid user name" (or the reverse) can realize that he or she has guessed one of these correctly.

In validation-checking code, the subprograms in the `DBMS_ASSERT` package are often useful. For example, you can use the `DBMS_ASSERT.ENQUOTE_LITERAL` function to enclose a string literal in quotation marks, as [Example 7-20](#) does. This prevents a malicious user from injecting text between an opening quotation mark and its corresponding closing quotation mark.

Caution:

Although the `DBMS_ASSERT` subprograms are useful in validation code, they do not replace it. For example, an input string can be a qualified SQL name (verified by `DBMS_ASSERT.QUALIFIED_SQL_NAME`) and still be a fraudulent password.

See Also:

Oracle Database PL/SQL Packages and Types Reference for information about `DBMS_ASSERT` subprograms

Example 7-20 Validation Checks Guarding Against SQL Injection

In this example, the procedure `raise_emp_salary` checks the validity of the column name that was passed to it before it updates the `employees` table, and then the anonymous block invokes the procedure from both a dynamic PL/SQL block and a dynamic SQL statement.

```
CREATE OR REPLACE PROCEDURE raise_emp_salary (
  column_value NUMBER,
  emp_column   VARCHAR2,
  amount NUMBER ) AUTHID DEFINER
IS
```

```

v_column VARCHAR2(30);
sql_stmt VARCHAR2(200);
BEGIN
  -- Check validity of column name that was given as input:
  SELECT column_name INTO v_column
  FROM USER_TAB_COLS
  WHERE TABLE_NAME = 'EMPLOYEES'
  AND COLUMN_NAME = emp_column;

  sql_stmt := 'UPDATE employees SET salary = salary + :1 WHERE '
  || DBMS_ASSERT.ENQUOTE_NAME(v_column, FALSE) || ' = :2';

  EXECUTE IMMEDIATE sql_stmt USING amount, column_value;

  -- If column name is valid:
  IF SQL%ROWCOUNT > 0 THEN
    DBMS_OUTPUT.PUT_LINE('Salaries were updated for: '
    || emp_column || ' = ' || column_value);
  END IF;

  -- If column name is not valid:
  EXCEPTION
    WHEN NO_DATA_FOUND THEN
      DBMS_OUTPUT.PUT_LINE ('Invalid Column: ' || emp_column);
END raise_emp_salary;
/

DECLARE
  plsql_block VARCHAR2(500);
BEGIN
  -- Invoke raise_emp_salary from a dynamic PL/SQL block:
  plsql_block :=
    'BEGIN raise_emp_salary(:cvalue, :cname, :amt); END;';

  EXECUTE IMMEDIATE plsql_block
    USING 110, 'DEPARTMENT_ID', 10;

  -- Invoke raise_emp_salary from a dynamic SQL statement:
  EXECUTE IMMEDIATE 'BEGIN raise_emp_salary(:cvalue, :cname, :amt); END;'
    USING 112, 'EMPLOYEE_ID', 10;
END;
/

```

Result:

```

Salaries were updated for: DEPARTMENT_ID = 110
Salaries were updated for: EMPLOYEE_ID = 112

```

7.4.2.3 Explicit Format Models

Using explicit locale-independent format models to construct SQL is recommended not only from a security perspective, but also to ensure that the dynamic SQL statement runs correctly in any globalization environment.

If you use datetime and numeric values that are concatenated into the text of a SQL or PL/SQL statement, and you cannot pass them as bind variables, convert them to text using explicit format models that are independent from the values of the NLS parameters of the running session. Ensure that the converted values have the format of SQL datetime or numeric literals.

Example 7-21 Explicit Format Models Guarding Against SQL Injection

This procedure is invulnerable to SQL injection because it converts the datetime parameter value, `SYSDATE - 30`, to a `VARCHAR2` value explicitly, using the `TO_CHAR` function and a locale-independent format model (not implicitly, as in the vulnerable procedure in [Example 7-18](#)).

Create invulnerable procedure:

```
-- Return records not older than a month

CREATE OR REPLACE PROCEDURE get_recent_record (
  user_name      IN  VARCHAR2,
  service_type   IN  VARCHAR2,
  rec            OUT VARCHAR2
) AUTHID DEFINER
IS
  query VARCHAR2(4000);
BEGIN
  /* Following SELECT statement is vulnerable to modification
     because it uses concatenation to build WHERE clause. */

  query := 'SELECT value FROM secret_records WHERE user_name='''
          || user_name
          || ''' AND service_type='''
          || service_type
          || ''' AND date_created> DATE '''
          || TO_CHAR(SYSDATE - 30, 'YYYY-MM-DD')
          || ''';

  DBMS_OUTPUT.PUT_LINE('Query: ' || query);
  EXECUTE IMMEDIATE query INTO rec;
  DBMS_OUTPUT.PUT_LINE('Rec: ' || rec);
END;
/
```

Try statement modification:

```
ALTER SESSION SET NLS_DATE_FORMAT='' OR service_type='Merger';

DECLARE
  record_value VARCHAR2(4000);
BEGIN
  get_recent_record('Anybody', 'Anything', record_value);
END;
/
```

Result:

```
Query: SELECT value FROM secret_records WHERE user_name='Anybody' AND
service_type='Anything' AND date_created> DATE '2010-03-29'
DECLARE
*
ERROR at line 1:
ORA-01403: no data found
ORA-06512: at "SYS.GET_RECENT_RECORD", line 21
ORA-06512: at line 4
```

8

PL/SQL Subprograms

A PL/SQL **subprogram** is a named PL/SQL block that can be invoked repeatedly. If the subprogram has parameters, their values can differ for each invocation.

A subprogram is either a procedure or a function. Typically, you use a procedure to perform an action and a function to compute and return a value.

Topics

- [Reasons to Use Subprograms](#)
- [Nested, Package, and Standalone Subprograms](#)
- [Subprogram Invocations](#)
- [Subprogram Properties](#)
- [Subprogram Parts](#)
- [Forward Declaration](#)
- [Subprogram Parameters](#)
- [Subprogram Invocation Resolution](#)
- [Overloaded Subprograms](#)
- [Recursive Subprograms](#)
- [Subprogram Side Effects](#)
- [PL/SQL Function Result Cache](#)
- [PL/SQL Functions that SQL Statements Can Invoke](#)
- [Invoker's Rights and Definer's Rights \(AUTHID Property\)](#)
- [External Subprograms](#)

8.1 Reasons to Use Subprograms

Subprograms support the development and maintenance of reliable, reusable code with the following features:

- **Modularity**
Subprograms let you break a program into manageable, well-defined modules.
- **Easier Application Design**
When designing an application, you can defer the implementation details of the subprograms until you have tested the main program, and then refine them one step at a time. (To define a subprogram without implementation details, use the `NULL` statement, as in [Example 4-35](#).)
- **Maintainability**

You can change the implementation details of a subprogram without changing its invokers.

- **Packageability**

Subprograms can be grouped into packages, whose advantages are explained in ["Reasons to Use Packages"](#).

- **Reusability**

Any number of applications, in many different environments, can use the same package subprogram or standalone subprogram.

- **Better Performance**

Each subprogram is compiled and stored in executable form, which can be invoked repeatedly. Because stored subprograms run in the database server, a single invocation over the network can start a large job. This division of work reduces network traffic and improves response times. Stored subprograms are cached and shared among users, which lowers memory requirements and invocation overhead.

Subprograms are an important component of other maintainability features, such as packages (explained in [PL/SQL Packages](#)) and Abstract Data Types (explained in ["Abstract Data Types"](#)).

8.2 Nested, Package, and Standalone Subprograms

You can create a subprogram either inside a PL/SQL block (which can be another subprogram), inside a package, or at schema level.

A subprogram created inside a PL/SQL block is a **nested subprogram**. You can either declare and define it at the same time, or you can declare it first and then define it later in the same block (see ["Forward Declaration"](#)). A nested subprogram is stored in the database only if it is nested in a standalone or package subprogram.

A subprogram created inside a package is a **package subprogram**. You declare it in the package specification and define it in the package body. It is stored in the database until you drop the package. (Packages are described in [PL/SQL Packages](#).)

A subprogram created at schema level is a **standalone subprogram**. You create it with the `CREATE FUNCTION` or `CREATE PROCEDURE` statement. It is stored in the database until you drop it with the `DROP FUNCTION` or `DROP PROCEDURE` statement. (These statements are described in [SQL Statements for Stored PL/SQL Units](#).)

A **stored subprogram** is either a package subprogram or a standalone subprogram. A stored subprogram is affected by the `AUTHID` and `ACCESSIBLE BY` clauses, which can appear in the `CREATE FUNCTION`, `CREATE PROCEDURE`, and `CREATE PACKAGE` statements. The `AUTHID` clause affects the name resolution and privilege checking of SQL statements that the subprogram issues at run time (for more information, see ["Invoker's Rights and Definer's Rights \(AUTHID Property\)"](#)). The `ACCESSIBLE BY` clause specifies a white list of PL/SQL units that can access the subprogram.

8.3 Subprogram Invocations

A subprogram invocation has this form:

```
subprogram_name [ ( [ parameter [, parameter]... ] ) ]
```

If the subprogram has no parameters, or specifies a default value for every parameter, you can either omit the parameter list or specify an empty parameter list.

A procedure invocation is a PL/SQL statement. For example:

```
raise_salary(employee_id, amount);
```

A function invocation is an expression. For example:

```
new_salary := get_salary(employee_id);  
IF salary_ok(new_salary, new_title) THEN ...
```



See Also:

"[Subprogram Parameters](#)" for more information about specifying parameters in subprogram invocations

8.4 Subprogram Properties

Each subprogram property can appear only once in the subprogram declaration. The properties can appear in any order. Properties appear before the `IS` or `AS` keyword in the subprogram heading. The properties cannot appear in nested subprograms.

Only the `ACCESSIBLE BY` property can appear in package subprograms. Standalone subprograms may have the following properties in their declaration.

- [ACCESSIBLE BY Clause](#)
- [DEFAULT COLLATION Clause](#)
- [Invoker's Rights and Definer's Rights \(AUTHID Property\)](#)

8.5 Subprogram Parts

A subprogram begins with a **subprogram heading**, which specifies its name and (optionally) its parameter list.

Like an anonymous block, a subprogram has these parts:

- **Declarative part (optional)**

This part declares and defines local types, cursors, constants, variables, exceptions, and nested subprograms. These items cease to exist when the subprogram completes execution.

This part can also specify pragmas.



Note:

The declarative part of a subprogram does not begin with the keyword `DECLARE`, as the declarative part of an anonymous block does.

- **Executable part (required)**

This part contains one or more statements that assign values, control execution, and manipulate data. (Early in the application design process, this part might contain only a `NULL` statement, as in [Example 4-35](#).)

- **Exception-handling part (optional)**

This part contains code that handles runtime errors.

Topics

- [Additional Parts for Functions](#)
- [RETURN Statement](#)

See Also:

- ["Pragmas"](#)
- ["Procedure Declaration and Definition"](#) for the syntax of procedure declarations and definitions
- ["Subprogram Parameters"](#) for more information about subprogram parameters

Example 8-1 Declaring, Defining, and Invoking a Simple PL/SQL Procedure

In this example, an anonymous block simultaneously declares and defines a procedure and invokes it three times. The third invocation raises the exception that the exception-handling part of the procedure handles.

```

DECLARE
    first_name employees.first_name%TYPE;
    last_name  employees.last_name%TYPE;
    email      employees.email%TYPE;
    employer   VARCHAR2(8) := 'AcmeCorp';

    -- Declare and define procedure

    PROCEDURE create_email ( -- Subprogram heading begins
        name1  VARCHAR2,
        name2  VARCHAR2,
        company VARCHAR2
    )          -- Subprogram heading ends
    IS
        -- Declarative part begins
        error_message VARCHAR2(30) := 'Email address is too long.';
    BEGIN     -- Executable part begins
        email := name1 || '.' || name2 || '@' || company;
    EXCEPTION -- Exception-handling part begins
        WHEN VALUE_ERROR THEN
            DBMS_OUTPUT.PUT_LINE(error_message);
    END create_email;

BEGIN
    first_name := 'John';
    last_name  := 'Doe';

    create_email(first_name, last_name, employer); -- invocation

```

```

DBMS_OUTPUT.PUT_LINE ('With first name first, email is: ' || email);

create_email(last_name, first_name, employer); -- invocation
DBMS_OUTPUT.PUT_LINE ('With last name first, email is: ' || email);

first_name := 'Elizabeth';
last_name  := 'MacDonald';
create_email(first_name, last_name, employer); -- invocation
END;
/

```

Result:

```

With first name first, email is: John.Doe@AcmeCorp
With last name first, email is: Doe.John@AcmeCorp
Email address is too long.

```

8.5.1 Additional Parts for Functions

A function has the same structure as a procedure, except that:

- A function heading must include a **RETURN clause**, which specifies the data type of the value that the function returns. (A procedure heading cannot have a RETURN clause.)
- In the executable part of a function, every execution path must lead to a **RETURN statement**. Otherwise, the PL/SQL compiler issues a compile-time warning. (In a procedure, the RETURN statement is optional and not recommended. For details, see ["RETURN Statement"](#).)
- A function declaration can include these options:

Option	Description
DETERMINISTIC option	Helps the optimizer avoid redundant function invocations.
PARALLEL_ENABLE option	Enables the function for parallel execution, making it safe for use in concurrent sessions of parallel DML evaluations.
PIPELINED option	Makes a table function pipelined, for use as a row source.
RESULT_CACHE option	Stores function results in the PL/SQL function result cache.

 **See Also:**

- ["Function Declaration and Definition"](#) for the syntax of function declarations and definitions, including descriptions of the items in the preceding table
- ["PL/SQL Function Result Cache"](#) for more information about the RESULT_CACHE option

Example 8-2 Declaring, Defining, and Invoking a Simple PL/SQL Function

In this example, an anonymous block simultaneously declares and defines a function and invokes it.

```

DECLARE
  -- Declare and define function

```

```
FUNCTION square (original NUMBER)  -- parameter list
RETURN NUMBER                      -- RETURN clause
AS
                                   -- Declarative part begins
    original_squared NUMBER;
BEGIN                               -- Executable part begins
    original_squared := original * original;
    RETURN original_squared;       -- RETURN statement
END;
BEGIN
    DBMS_OUTPUT.PUT_LINE(square(100)); -- invocation
END;
/
```

Result:

10000

8.5.2 RETURN Statement

The `RETURN` statement immediately ends the execution of the subprogram or anonymous block that contains it. A subprogram or anonymous block can contain multiple `RETURN` statements.

Topics

- [RETURN Statement in Function](#)
- [RETURN Statement in Procedure](#)
- [RETURN Statement in Anonymous Block](#)



See Also:

"[RETURN Statement](#)" for the syntax of the `RETURN` statement

8.5.2.1 RETURN Statement in Function

In a function, every execution path must lead to a `RETURN` statement and every `RETURN` statement must specify an expression. The `RETURN` statement assigns the value of the expression to the function identifier and returns control to the invoker, where execution resumes immediately after the invocation.



Note:

In a pipelined table function, a `RETURN` statement need not specify an expression. For information about the parts of a pipelined table function, see "[Creating Pipelined Table Functions](#)".

In [Example 8-3](#), the anonymous block invokes the same function twice. The first time, the `RETURN` statement returns control to the inside of the invoking statement. The

second time, the `RETURN` statement returns control to the statement immediately after the invoking statement.

In [Example 8-4](#), the function has multiple `RETURN` statements, but if the parameter is not 0 or 1, then no execution path leads to a `RETURN` statement. The function compiles with warning PLW-05005: subprogram F returns without value at line 11.

[Example 8-5](#) is like [Example 8-4](#), except for the addition of the `ELSE` clause. Every execution path leads to a `RETURN` statement, and the function compiles without warning PLW-05005.

Example 8-3 Execution Resumes After RETURN Statement in Function

```
DECLARE
  x INTEGER;

  FUNCTION f (n INTEGER)
  RETURN INTEGER
  IS
  BEGIN
    RETURN (n*n);
  END;

BEGIN
  DBMS_OUTPUT.PUT_LINE (
    'f returns ' || f(2) || '. Execution returns here (1). '
  );

  x := f(2);
  DBMS_OUTPUT.PUT_LINE('Execution returns here (2).');
END;
/
```

Result:

```
f returns 4. Execution returns here (1).Execution returns here (2).
```

Example 8-4 Function Where Not Every Execution Path Leads to RETURN Statement

```
CREATE OR REPLACE FUNCTION f (n INTEGER)
  RETURN INTEGER
  AUTHID DEFINER
  IS
  BEGIN
    IF n = 0 THEN
      RETURN 1;
    ELSIF n = 1 THEN
      RETURN n;
    END IF;
  END;
/
```

Example 8-5 Function Where Every Execution Path Leads to RETURN Statement

```
CREATE OR REPLACE FUNCTION f (n INTEGER)
  RETURN INTEGER
  AUTHID DEFINER
  IS
  BEGIN
    IF n = 0 THEN
      RETURN 1;
    ELSIF n = 1 THEN
```

```
        RETURN n;  
    ELSE  
        RETURN n*n;  
    END IF;  
END;  
/  
BEGIN  
    FOR i IN 0 .. 3 LOOP  
        DBMS_OUTPUT.PUT_LINE('f(' || i || ') = ' || f(i));  
    END LOOP;  
END;  
/
```

Result:

```
f(0) = 1  
f(1) = 1  
f(2) = 4  
f(3) = 9
```

8.5.2.2 RETURN Statement in Procedure

In a procedure, the `RETURN` statement returns control to the invoker, where execution resumes immediately after the invocation. The `RETURN` statement cannot specify an expression.

In [Example 8-6](#), the `RETURN` statement returns control to the statement immediately after the invoking statement.

Example 8-6 Execution Resumes After RETURN Statement in Procedure

```
DECLARE  
    PROCEDURE p IS  
    BEGIN  
        DBMS_OUTPUT.PUT_LINE('Inside p');  
        RETURN;  
        DBMS_OUTPUT.PUT_LINE('Unreachable statement.');    END;  
BEGIN  
    P;  
    DBMS_OUTPUT.PUT_LINE('Control returns here.');END;  
/
```

Result:

```
Inside p  
Control returns here.
```

8.5.2.3 RETURN Statement in Anonymous Block

In an anonymous block, the `RETURN` statement exits its own block and all enclosing blocks. The `RETURN` statement cannot specify an expression.

In [Example 8-7](#), the `RETURN` statement exits both the inner and outer block.

Example 8-7 Execution Resumes After RETURN Statement in Anonymous Block

```
BEGIN
  BEGIN
    DBMS_OUTPUT.PUT_LINE('Inside inner block.');
```

RETURN;

```
    DBMS_OUTPUT.PUT_LINE('Unreachable statement.');
```

END;

```
  DBMS_OUTPUT.PUT_LINE('Inside outer block. Unreachable statement.');
```

END;

```
/
```

Result:

Inside inner block.

8.6 Forward Declaration

If nested subprograms in the same PL/SQL block invoke each other, then one requires a forward declaration, because a subprogram must be declared before it can be invoked.

A **forward declaration** declares a nested subprogram but does not define it. You must define it later in the same block. The forward declaration and the definition must have the same subprogram heading.

In [Example 8-8](#), an anonymous block creates two procedures that invoke each other.

Example 8-8 Nested Subprograms Invoke Each Other

```
DECLARE
  -- Declare proc1 (forward declaration):
  PROCEDURE proc1(number1 NUMBER);

  -- Declare and define proc2:
  PROCEDURE proc2(number2 NUMBER) IS
  BEGIN
    proc1(number2);
  END;

  -- Define proc 1:
  PROCEDURE proc1(number1 NUMBER) IS
  BEGIN
    proc2 (number1);
  END;

BEGIN
  NULL;
END;
/
```

8.7 Subprogram Parameters

If a subprogram has parameters, their values can differ for each invocation.

Topics

- [Formal and Actual Subprogram Parameters](#)
- [Subprogram Parameter Passing Methods](#)

- [Subprogram Parameter Modes](#)
- [Subprogram Parameter Aliasing](#)
- [Default Values for IN Subprogram Parameters](#)
- [Positional, Named, and Mixed Notation for Actual Parameters](#)

8.7.1 Formal and Actual Subprogram Parameters

If you want a subprogram to have parameters, declare **formal parameters** in the subprogram heading. In each formal parameter declaration, specify the name and data type of the parameter, and (optionally) its mode and default value. In the execution part of the subprogram, reference the formal parameters by their names.

When invoking the subprogram, specify the **actual parameters** whose values are to be assigned to the formal parameters. Corresponding actual and formal parameters must have compatible data types.

Note:

You can declare a formal parameter of a constrained subtype, like this:

```
DECLARE
  SUBTYPE n1 IS NUMBER(1);
  SUBTYPE v1 IS VARCHAR2(1);

  PROCEDURE p (n n1, v v1) IS ...
```

But you cannot include a constraint in a formal parameter declaration, like this:

```
DECLARE
  PROCEDURE p (n NUMBER(1), v VARCHAR2(1)) IS ...
```

Tip:

To avoid confusion, use different names for formal and actual parameters.

Note:

- Actual parameters (including default values of formal parameters) can be evaluated in any order. If a program determines order of evaluation, then at the point where the program does so, its behavior is undefined.
- You cannot use LOB parameters in a server-to-server remote procedure call (RPC).

In [Example 8-9](#), the procedure has formal parameters `emp_id` and `amount`. In the first procedure invocation, the corresponding actual parameters are `emp_num` and `bonus`, whose value are 120 and 100, respectively. In the second procedure invocation, the actual parameters are `emp_num` and `merit + bonus`, whose value are 120 and 150, respectively.

Topics:

- [Formal Parameters of Constrained Subtypes](#)

See Also:

- ["Formal Parameter Declaration"](#) for the syntax and semantics of a formal parameter declaration
- ["function_call ::="](#) and ["function_call"](#) for the syntax and semantics of a function invocation
- ["procedure_call ::="](#) and ["procedure"](#) for the syntax and semantics of a procedure invocation

Example 8-9 Formal Parameters and Actual Parameters

```

DECLARE
    emp_num NUMBER(6) := 120;
    bonus   NUMBER(6) := 100;
    merit   NUMBER(4) := 50;

    PROCEDURE raise_salary (
        emp_id NUMBER, -- formal parameter
        amount NUMBER  -- formal parameter
    ) IS
    BEGIN
        UPDATE employees
        SET salary = salary + amount -- reference to formal parameter
        WHERE employee_id = emp_id;  -- reference to formal parameter
    END raise_salary;

BEGIN
    raise_salary(emp_num, bonus);          -- actual parameters

    /* raise_salary runs this statement:
       UPDATE employees
       SET salary = salary + 100
       WHERE employee_id = 120;          */

    raise_salary(emp_num, merit + bonus); -- actual parameters

    /* raise_salary runs this statement:
       UPDATE employees
       SET salary = salary + 150
       WHERE employee_id = 120;          */
END;
/

```

8.7.1.1 Formal Parameters of Constrained Subtypes

If the data type of a formal parameter is a constrained subtype, then:

- If the subtype has the `NOT NULL` constraint, then the actual parameter inherits it.
- If the subtype has the base type `VARCHAR2`, then the actual parameter does not inherit the size of the subtype.
- If the subtype has a numeric base type, then the actual parameter inherits the range of the subtype, but not the precision or scale.

 **Note:**

In a function, the clause `RETURN datatype` declares a hidden formal parameter and the statement `RETURN value` specifies the corresponding actual parameter. Therefore, if `datatype` is a constrained data type, then the preceding rules apply to `value` (see [Example 8-11](#)).

[Example 8-10](#) shows that an actual subprogram parameter inherits the `NOT NULL` constraint but not the size of a `VARCHAR2` subtype.

As [PL/SQL Predefined Data Types](#) shows, PL/SQL has many predefined data types that are constrained subtypes of other data types. For example, `INTEGER` is a constrained subtype of `NUMBER`:

```
SUBTYPE INTEGER IS NUMBER(38,0);
```

In [Example 8-11](#), the function has both an `INTEGER` formal parameter and an `INTEGER` return type. The anonymous block invokes the function with an actual parameter that is not an integer. Because the actual parameter inherits the range but not the precision and scale of `INTEGER`, and the actual parameter is in the `INTEGER` range, the invocation succeeds. For the same reason, the `RETURN` statement succeeds in returning the noninteger value.

In [Example 8-12](#), the function implicitly converts its formal parameter to the constrained subtype `INTEGER` before returning it.

 **See Also:**

["Constrained Subtypes"](#) for general information about constrained subtypes

Example 8-10 Actual Parameter Inherits Only NOT NULL from Subtype

```
DECLARE
  SUBTYPE License IS VARCHAR2(7) NOT NULL;
  n License := 'DLLLLDD';

  PROCEDURE p (x License) IS
  BEGIN
    DBMS_OUTPUT.PUT_LINE(x);
```

```

END;

BEGIN
  p('1ABC123456789'); -- Succeeds; size is not inherited
  p(NULL);           -- Raises error; NOT NULL is inherited
END;
/

```

Result:

```

  p(NULL);           -- Raises error; NOT NULL is inherited
*
ERROR at line 12:
ORA-06550: line 12, column 5:
PLS-00567: cannot pass NULL to a NOT NULL constrained formal parameter
ORA-06550: line 12, column 3:
PL/SQL: Statement ignored

```

Example 8-11 Actual Parameter and Return Value Inherit Only Range From Subtype

```

DECLARE
  FUNCTION test (p INTEGER) RETURN INTEGER IS
  BEGIN
    DBMS_OUTPUT.PUT_LINE('p = ' || p);
    RETURN p;
  END test;

BEGIN
  DBMS_OUTPUT.PUT_LINE('test(p) = ' || test(0.66));
END;
/

```

Result:

```

p = .66
test(p) = .66

```

PL/SQL procedure successfully completed.

Example 8-12 Function Implicitly Converts Formal Parameter to Constrained Subtype

```

DECLARE
  FUNCTION test (p NUMBER) RETURN NUMBER IS
    q INTEGER := p; -- Implicitly converts p to INTEGER
  BEGIN
    DBMS_OUTPUT.PUT_LINE('p = ' || q); -- Display q, not p
    RETURN q;                          -- Return q, not p
  END test;

BEGIN
  DBMS_OUTPUT.PUT_LINE('test(p) = ' || test(0.66));
END;
/

```

Result:

```

p = 1
test(p) = 1

```

PL/SQL procedure successfully completed.

8.7.2 Subprogram Parameter Passing Methods

The PL/SQL compiler has two ways of passing an actual parameter to a subprogram:

- **By reference**

The compiler passes the subprogram a pointer to the actual parameter. The actual and formal parameters refer to the same memory location.

- **By value**

The compiler assigns the value of the actual parameter to the corresponding formal parameter. The actual and formal parameters refer to different memory locations.

If necessary, the compiler implicitly converts the data type of the actual parameter to the data type of the formal parameter. For information about implicit data conversion, see *Oracle Database SQL Language Reference*.

 **Tip:**

Avoid implicit data conversion (for the reasons in *Oracle Database SQL Language Reference*), in either of these ways:

- Declare the variables that you intend to use as actual parameters with the same data types as their corresponding formal parameters (as in the declaration of variable *x* in [Example 8-13](#)).
- Explicitly convert actual parameters to the data types of their corresponding formal parameters, using the SQL conversion functions described in *Oracle Database SQL Language Reference* (as in the third invocation of the procedure in [Example 8-13](#)).

In [Example 8-13](#), the procedure *p* has one parameter, *n*, which is passed by value. The anonymous block invokes *p* three times, avoiding implicit conversion twice.

The method by which the compiler passes a specific actual parameter depends on its mode, as explained in "[Subprogram Parameter Modes](#)".

Example 8-13 Avoiding Implicit Conversion of Actual Parameters

```
CREATE OR REPLACE PROCEDURE p (
  n NUMBER
) AUTHID DEFINER IS
BEGIN
  NULL;
END;
/
DECLARE
  x NUMBER      := 1;
  y VARCHAR2(1) := '1';
BEGIN
  p(x);          -- No conversion needed
  p(y);          -- z implicitly converted from VARCHAR2 to NUMBER
  p(TO_NUMBER(y)); -- z explicitly converted from VARCHAR2 to NUMBER
END;
/
```

8.7.3 Subprogram Parameter Modes

The **mode** of a formal parameter determines its behavior.

[Table 8-1](#) summarizes and compares the characteristics of the subprogram parameter modes.

Table 8-1 PL/SQL Subprogram Parameter Modes

Parameter Mode	Is Default?	Role
IN	Default mode	Passes a value to the subprogram.
OUT	Must be specified.	Returns a value to the invoker.
IN OUT	Must be specified.	Passes an initial value to the subprogram and returns an updated value to the invoker.

Table 8-2 PL/SQL Subprogram Parameter Modes Characteristics

Parameter Mode	Formal Parameter	Actual Parameter	Passed by Reference ?
IN	Formal parameter acts like a constant: When the subprogram begins, its value is that of either its actual parameter or default value, and the subprogram cannot change this value.	Actual parameter can be a constant, initialized variable, literal, or expression.	Actual parameter is passed by reference.
OUT	Formal parameter is initialized to the default value of its type. The default value of the type is <code>NULL</code> except for a record type with a non- <code>NULL</code> default value (see Example 8-16). When the subprogram begins, the formal parameter has its initial value regardless of the value of its actual parameter. Oracle recommends that the subprogram assign a value to the formal parameter.	If the default value of the formal parameter type is <code>NULL</code> , then the actual parameter must be a variable whose data type is not defined as <code>NOT NULL</code> .	By default, actual parameter is passed by value; if you specify <code>NOCOPY</code> , it might be passed by reference.
IN OUT	Formal parameter acts like an initialized variable: When the subprogram begins, its value is that of its actual parameter. Oracle recommends that the subprogram update its value.	Actual parameter must be a variable (typically, it is a string buffer or numeric accumulator).	By default, actual parameter is passed by value (in both directions); if you specify <code>NOCOPY</code> , it might be passed by reference.

 **Tip:**

Do not use `OUT` and `IN OUT` for function parameters. Ideally, a function takes zero or more parameters and returns a single value. A function with `IN OUT` parameters returns multiple values and has side effects.

 **Note:**

The specifications of many packages and types that Oracle Database supplies declare formal parameters with this notation:

```
i1 IN VARCHAR2 CHARACTER SET ANY_CS
i2 IN VARCHAR2 CHARACTER SET i1%CHARSET
```

Do not use this notation when declaring your own formal or actual parameters. It is reserved for Oracle implementation of the supplied packages types.

Regardless of how an `OUT` or `IN OUT` parameter is passed:

- If the subprogram exits successfully, then the value of the actual parameter is the final value assigned to the formal parameter. (The formal parameter is assigned at least one value—the initial value.)
- If the subprogram ends with an exception, then the value of the actual parameter is undefined.
- Formal `OUT` and `IN OUT` parameters can be returned in any order. In this example, the final values of `x` and `y` are undefined:

```
CREATE OR REPLACE PROCEDURE p (x OUT INTEGER, y OUT INTEGER) AS
BEGIN
  x := 17; y := 93;
END;
/
```

When an `OUT` or `IN OUT` parameter is passed by reference, the actual and formal parameters refer to the same memory location. Therefore, if the subprogram changes the value of the formal parameter, the change shows immediately in the actual parameter (see "[Subprogram Parameter Aliasing with Parameters Passed by Reference](#)").

In [Example 8-14](#), the procedure `p` has two `IN` parameters, one `OUT` parameter, and one `IN OUT` parameter. The `OUT` and `IN OUT` parameters are passed by value (the default). The anonymous block invokes `p` twice, with different actual parameters. Before each invocation, the anonymous block prints the values of the actual parameters. The procedure `p` prints the initial values of its formal parameters. After each invocation, the anonymous block prints the values of the actual parameters again.

In [Example 8-15](#), the anonymous block invokes procedure `p` (from [Example 8-14](#)) with an actual parameter that causes `p` to raise the predefined exception `ZERO_DIVIDE`, which `p` does not handle. The exception propagates to the anonymous block, which handles `ZERO_DIVIDE` and shows that the actual parameters for the `IN` and `IN OUT`

parameters of `p` have retained the values that they had before the invocation. (Exception propagation is explained in ["Exception Propagation"](#).)

In [Example 8-16](#), the procedure `p` has three `OUT` formal parameters: `x`, of a record type with a non-NULL default value; `y`, of a record type with no non-NULL default value; and `z`, which is not a record.

The corresponding actual parameters for `x`, `y`, and `z` are `r1`, `r2`, and `s`, respectively. `s` is declared with an initial value. However, when `p` is invoked, the value of `s` is initialized to `NULL`. The values of `r1` and `r2` are initialized to the default values of their record types, `'abcde'` and `NULL`, respectively.

Example 8-14 Parameter Values Before, During, and After Procedure Invocation

```
CREATE OR REPLACE PROCEDURE p (
  a      PLS_INTEGER, -- IN by default
  b      IN PLS_INTEGER,
  c      OUT PLS_INTEGER,
  d      IN OUT BINARY_FLOAT
) AUTHID DEFINER IS
BEGIN
  -- Print values of parameters:

  DBMS_OUTPUT.PUT_LINE('Inside procedure p:');

  DBMS_OUTPUT.PUT('IN a = ');
  DBMS_OUTPUT.PUT_LINE(NVL(TO_CHAR(a), 'NULL'));

  DBMS_OUTPUT.PUT('IN b = ');
  DBMS_OUTPUT.PUT_LINE(NVL(TO_CHAR(b), 'NULL'));

  DBMS_OUTPUT.PUT('OUT c = ');
  DBMS_OUTPUT.PUT_LINE(NVL(TO_CHAR(c), 'NULL'));

  DBMS_OUTPUT.PUT_LINE('IN OUT d = ' || TO_CHAR(d));

  -- Can reference IN parameters a and b,
  -- but cannot assign values to them.

  c := a+10; -- Assign value to OUT parameter
  d := 10/b; -- Assign value to IN OUT parameter
END;
/
DECLARE
  aa CONSTANT PLS_INTEGER := 1;
  bb PLS_INTEGER := 2;
  cc PLS_INTEGER := 3;
  dd BINARY_FLOAT := 4;
  ee PLS_INTEGER;
  ff BINARY_FLOAT := 5;
BEGIN
  DBMS_OUTPUT.PUT_LINE('Before invoking procedure p:');

  DBMS_OUTPUT.PUT('aa = ');
  DBMS_OUTPUT.PUT_LINE(NVL(TO_CHAR(aa), 'NULL'));

  DBMS_OUTPUT.PUT('bb = ');
  DBMS_OUTPUT.PUT_LINE(NVL(TO_CHAR(bb), 'NULL'));

  DBMS_OUTPUT.PUT('cc = ');
  DBMS_OUTPUT.PUT_LINE(NVL(TO_CHAR(cc), 'NULL'));
```

```
DBMS_OUTPUT.PUT_LINE('dd = ' || TO_CHAR(dd));

p (aa, -- constant
   bb, -- initialized variable
   cc, -- initialized variable
   dd -- initialized variable
);

DBMS_OUTPUT.PUT_LINE('After invoking procedure p:');

DBMS_OUTPUT.PUT('aa = ');
DBMS_OUTPUT.PUT_LINE(NVL(TO_CHAR(aa), 'NULL'));

DBMS_OUTPUT.PUT('bb = ');
DBMS_OUTPUT.PUT_LINE(NVL(TO_CHAR(bb), 'NULL'));

DBMS_OUTPUT.PUT('cc = ');
DBMS_OUTPUT.PUT_LINE(NVL(TO_CHAR(cc), 'NULL'));

DBMS_OUTPUT.PUT_LINE('dd = ' || TO_CHAR(dd));

DBMS_OUTPUT.PUT_LINE('Before invoking procedure p:');

DBMS_OUTPUT.PUT('ee = ');
DBMS_OUTPUT.PUT_LINE(NVL(TO_CHAR(ee), 'NULL'));

DBMS_OUTPUT.PUT_LINE('ff = ' || TO_CHAR(ff));

p (1,      -- literal
   (bb+3)*4, -- expression
   ee,     -- uninitialized variable
   ff      -- initialized variable
);

DBMS_OUTPUT.PUT_LINE('After invoking procedure p:');

DBMS_OUTPUT.PUT('ee = ');
DBMS_OUTPUT.PUT_LINE(NVL(TO_CHAR(ee), 'NULL'));

DBMS_OUTPUT.PUT_LINE('ff = ' || TO_CHAR(ff));
END;
/
```

Result:

```
Before invoking procedure p:
aa = 1
bb = 2
cc = 3
dd = 4.0E+000
Inside procedure p:
IN a = 1
IN b = 2
OUT c = NULL
IN OUT d = 4.0E+000
After invoking procedure p:
aa = 1
bb = 2
cc = 11
dd = 5.0E+000
```



```

Before invoking procedure p:
ee = NULL
ff = 5.0E+000
Inside procedure p:
IN a = 1
IN b = 20
OUT c = NULL
IN OUT d = 5.0E+000
After invoking procedure p:
ee = 11
ff = 5.0E-001

```

PL/SQL procedure successfully completed.

Example 8-15 OUT and IN OUT Parameter Values After Exception Handling

```

DECLARE
  j PLS_INTEGER := 10;
  k BINARY_FLOAT := 15;
BEGIN
  DBMS_OUTPUT.PUT_LINE('Before invoking procedure p:');

  DBMS_OUTPUT.PUT('j = ');
  DBMS_OUTPUT.PUT_LINE(NVL(TO_CHAR(j), 'NULL'));

  DBMS_OUTPUT.PUT_LINE('k = ' || TO_CHAR(k));

  p(4, 0, j, k); -- causes p to exit with exception ZERO_DIVIDE

EXCEPTION
  WHEN ZERO_DIVIDE THEN
    DBMS_OUTPUT.PUT_LINE('After invoking procedure p:');

    DBMS_OUTPUT.PUT('j = ');
    DBMS_OUTPUT.PUT_LINE(NVL(TO_CHAR(j), 'NULL'));

    DBMS_OUTPUT.PUT_LINE('k = ' || TO_CHAR(k));
END;
/

```

Result:

```

Before invoking procedure p:
j = 10
k = 1.5E+001
Inside procedure p:
IN a = 4
IN b = 0
OUT c = NULL
IN OUT d = 1.5E+001
After invoking procedure p:
j = 10
k = 1.5E+001

```

PL/SQL procedure successfully completed.

Example 8-16 OUT Formal Parameter of Record Type with Non-NULL Default Value

```

CREATE OR REPLACE PACKAGE r_types AUTHID DEFINER IS
  TYPE r_type_1 IS RECORD (f VARCHAR2(5) := 'abcde');
  TYPE r_type_2 IS RECORD (f VARCHAR2(5));
END;

```

```

/

CREATE OR REPLACE PROCEDURE p (
  x OUT r_types.r_type_1,
  y OUT r_types.r_type_2,
  z OUT VARCHAR2)
AUTHID CURRENT_USER IS
BEGIN
  DBMS_OUTPUT.PUT_LINE('x.f is ' || NVL(x.f, 'NULL'));
  DBMS_OUTPUT.PUT_LINE('y.f is ' || NVL(y.f, 'NULL'));
  DBMS_OUTPUT.PUT_LINE('z is ' || NVL(z, 'NULL'));
END;
/

DECLARE
  r1 r_types.r_type_1;
  r2 r_types.r_type_2;
  s VARCHAR2(5) := 'fghij';
BEGIN
  p (r1, r2, s);
END;
/

```

Result:

```

x.f is abcde
y.f is NULL
z is NULL

```

PL/SQL procedure successfully completed.

8.7.4 Subprogram Parameter Aliasing

Aliasing is having two different names for the same memory location. If a stored item is visible by more than one path, and you can change the item by one path, then you can see the change by all paths.

Subprogram parameter aliasing always occurs when the compiler passes an actual parameter by reference, and can also occur when a subprogram has cursor variable parameters.

Topics

- [Subprogram Parameter Aliasing with Parameters Passed by Reference](#)
- [Subprogram Parameter Aliasing with Cursor Variable Parameters](#)

8.7.4.1 Subprogram Parameter Aliasing with Parameters Passed by Reference

When the compiler passes an actual parameter by reference, the actual and formal parameters refer to the same memory location. Therefore, if the subprogram changes the value of the formal parameter, the change shows immediately in the actual parameter.

The compiler always passes `IN` parameters by reference, but the resulting aliasing cannot cause problems, because subprograms cannot assign values to `IN` parameters.

The compiler *might* pass an `OUT` or `IN OUT` parameter by reference, if you specify `NOCOPY` for that parameter. `NOCOPY` is only a hint—each time the subprogram is invoked,

the compiler decides, silently, whether to obey or ignore `NOCOPY`. Therefore, aliasing can occur for one invocation but not another, making subprogram results indeterminate. For example:

- If the actual parameter is a global variable, then an assignment to the formal parameter *might* show in the global parameter (see [Example 8-17](#)).
- If the same variable is the actual parameter for two formal parameters, then an assignment to either formal parameter *might* show immediately in both formal parameters (see [Example 8-18](#)).
- If the actual parameter is a package variable, then an assignment to either the formal parameter or the package variable *might* show immediately in both the formal parameter and the package variable.
- If the subprogram is exited with an unhandled exception, then an assignment to the formal parameter *might* show in the actual parameter.



See Also:

"`NOCOPY`" for the cases in which the compiler always ignores `NOCOPY`

In [Example 8-17](#), the procedure has an `IN OUT NOCOPY` formal parameter, to which it assigns the value `'aardvark'`. The anonymous block assigns the value `'aardwolf'` to a global variable and then passes the global variable to the procedure. If the compiler obeys the `NOCOPY` hint, then the final value of the global variable is `'aardvark'`. If the compiler ignores the `NOCOPY` hint, then the final value of the global variable is `'aardwolf'`.

In [Example 8-18](#), the procedure has an `IN` parameter, an `IN OUT` parameter, and an `IN OUT NOCOPY` parameter. The anonymous block invokes the procedure, using the same actual parameter, a global variable, for all three formal parameters. The procedure changes the value of the `IN OUT` parameter before it changes the value of the `IN OUT NOCOPY` parameter. However, if the compiler obeys the `NOCOPY` hint, then the latter change shows in the actual parameter immediately. The former change shows in the actual parameter after the procedure is exited successfully and control returns to the anonymous block.

Example 8-17 Aliasing from Global Variable as Actual Parameter

```
DECLARE
  TYPE Definition IS RECORD (
    word      VARCHAR2(20),
    meaning   VARCHAR2(200)
  );

  TYPE Dictionary IS VARRAY(2000) OF Definition;

  lexicon Dictionary := Dictionary(); -- global variable

  PROCEDURE add_entry (
    word_list IN OUT NOCOPY Dictionary -- formal NOCOPY parameter
  ) IS
  BEGIN
    word_list(1).word := 'aardvark';
  END;

BEGIN
```

```

lexicon.EXTEND;
lexicon(1).word := 'aardwolf';
add_entry(lexicon); -- global variable is actual parameter
DBMS_OUTPUT.PUT_LINE(lexicon(1).word);
END;
/

```

Result:

```
aardvark
```

Example 8-18 Aliasing from Same Actual Parameter for Multiple Formal Parameters

```

DECLARE
  n NUMBER := 10;

  PROCEDURE p (
    n1 IN NUMBER,
    n2 IN OUT NUMBER,
    n3 IN OUT NOCOPY NUMBER
  ) IS
  BEGIN
    n2 := 20; -- actual parameter is 20 only after procedure succeeds
    DBMS_OUTPUT.put_line(n1); -- actual parameter value is still 10
    n3 := 30; -- might change actual parameter immediately
    DBMS_OUTPUT.put_line(n1); -- actual parameter value is either 10 or 30
  END;

BEGIN
  p(n, n, n);
  DBMS_OUTPUT.put_line(n);
END;
/

```

Result if the compiler obeys the `NOCOPY` hint:

```

10
30
20

```

Result if the compiler ignores the `NOCOPY` hint:

```

10
10
30

```

8.7.4.2 Subprogram Parameter Aliasing with Cursor Variable Parameters

Cursor variable parameters are pointers. Therefore, if a subprogram assigns one cursor variable parameter to another, they refer to the same memory location. This aliasing can have unintended results.

In [Example 8-19](#), the procedure has two cursor variable parameters, `emp_cv1` and `emp_cv2`. The procedure opens `emp_cv1` and assigns its value (which is a pointer) to `emp_cv2`. Now `emp_cv1` and `emp_cv2` refer to the same memory location. When the procedure closes `emp_cv1`, it also closes `emp_cv2`. Therefore, when the procedure tries to fetch from `emp_cv2`, PL/SQL raises an exception.

Example 8-19 Aliasing from Cursor Variable Subprogram Parameters

```

DECLARE
  TYPE EmpCurTyp IS REF CURSOR;
  c1 EmpCurTyp;
  c2 EmpCurTyp;

  PROCEDURE get_emp_data (
    emp_cv1 IN OUT EmpCurTyp,
    emp_cv2 IN OUT EmpCurTyp
  )
  IS
    emp_rec employees%ROWTYPE;
  BEGIN
    OPEN emp_cv1 FOR SELECT * FROM employees;
    emp_cv2 := emp_cv1; -- now both variables refer to same location
    FETCH emp_cv1 INTO emp_rec; -- fetches first row of employees
    FETCH emp_cv1 INTO emp_rec; -- fetches second row of employees
    FETCH emp_cv2 INTO emp_rec; -- fetches third row of employees
    CLOSE emp_cv1; -- closes both variables
    FETCH emp_cv2 INTO emp_rec; -- causes error when get_emp_data is invoked
  END;
BEGIN
  get_emp_data(c1, c2);
END;
/

```

Result:

```

DECLARE
*
ERROR at line 1:
ORA-01001: invalid cursor
ORA-06512: at line 19
ORA-06512: at line 22

```

8.7.5 Default Values for IN Subprogram Parameters

When you declare a formal `IN` parameter, you can specify a default value for it. A formal parameter with a default value is called an **optional parameter**, because its corresponding actual parameter is optional in a subprogram invocation. If the actual parameter is omitted, then the invocation assigns the default value to the formal parameter. A formal parameter with no default value is called a **required parameter**, because its corresponding actual parameter is required in a subprogram invocation.

Omitting an actual parameter does not make the value of the corresponding formal parameter `NULL`. To make the value of a formal parameter `NULL`, specify `NULL` as either the default value or the actual parameter.

In [Example 8-20](#), the procedure has one required parameter and two optional parameters.

In [Example 8-20](#), the procedure invocations specify the actual parameters in the same order as their corresponding formal parameters are declared—that is, the invocations use positional notation. Positional notation does not let you omit the second parameter of `raise_salary` but specify the third; to do that, you must use either named or mixed notation. For more information, see "[Positional, Named, and Mixed Notation for Actual Parameters](#)".

The default value of a formal parameter can be any expression whose value can be assigned to the parameter; that is, the value and parameter must have compatible data types. If a

subprogram invocation specifies an actual parameter for the formal parameter, then that invocation does not evaluate the default value.

In [Example 8-21](#), the procedure `p` has a parameter whose default value is an invocation of the function `f`. The function `f` increments the value of a global variable. When `p` is invoked without an actual parameter, `p` invokes `f`, and `f` increments the global variable. When `p` is invoked with an actual parameter, `p` does not invoke `f`, and value of the global variable does not change.

[Example 8-22](#) creates a procedure with two required parameters, invokes it, and then adds a third, optional parameter. Because the third parameter is optional, the original invocation remains valid.

Example 8-20 Procedure with Default Parameter Values

```
DECLARE
  PROCEDURE raise_salary (
    emp_id IN employees.employee_id%TYPE,
    amount IN employees.salary%TYPE := 100,
    extra  IN employees.salary%TYPE := 50
  ) IS
  BEGIN
    UPDATE employees
    SET salary = salary + amount + extra
    WHERE employee_id = emp_id;
  END raise_salary;

BEGIN
  raise_salary(120);      -- same as raise_salary(120, 100, 50)
  raise_salary(121, 200); -- same as raise_salary(121, 200, 50)
END;
/
```

Example 8-21 Function Provides Default Parameter Value

```
DECLARE
  global PLS_INTEGER := 0;

  FUNCTION f RETURN PLS_INTEGER IS
  BEGIN
    DBMS_OUTPUT.PUT_LINE('Inside f. ');
    global := global + 1;
    RETURN global * 2;
  END f;

  PROCEDURE p (
    x IN PLS_INTEGER := f()
  ) IS
  BEGIN
    DBMS_OUTPUT.PUT_LINE (
      'Inside p. ' ||
      ' global = ' || global ||
      ', x = ' || x || '. '
    );
    DBMS_OUTPUT.PUT_LINE('-----');
  END p;

  PROCEDURE pre_p IS
  BEGIN
    DBMS_OUTPUT.PUT_LINE (
      'Before invoking p, global = ' || global || '. '
    );
  END pre_p;
```

```

    );
    DBMS_OUTPUT.PUT_LINE('Invoking p.');
```

END pre_p;

```

BEGIN
  pre_p;
  p();    -- default expression is evaluated

  pre_p;
  p(100); -- default expression is not evaluated

  pre_p;
  p();    -- default expression is evaluated
END;
/
```

Result:

```

Before invoking p, global = 0.
Invoking p.
Inside f.
Inside p.  global = 1, x = 2.
-----
Before invoking p, global = 1.
Invoking p.
Inside p.  global = 1, x = 100.
-----
Before invoking p, global = 1.
Invoking p.
Inside f.
Inside p.  global = 2, x = 4.
-----
```

Example 8-22 Adding Subprogram Parameter Without Changing Existing Invocations**Create procedure:**

```

CREATE OR REPLACE PROCEDURE print_name (
  first VARCHAR2,
  last VARCHAR2
) AUTHID DEFINER IS
BEGIN
  DBMS_OUTPUT.PUT_LINE(first || ' ' || last);
END print_name;
/
```

Invoke procedure:

```

BEGIN
  print_name('John', 'Doe');
END;
/
```

Result:

```
John Doe
```

Add third parameter with default value:

```

CREATE OR REPLACE PROCEDURE print_name (
  first VARCHAR2,
  last VARCHAR2,
```

```

    mi VARCHAR2 := NULL
) AUTHID DEFINER IS
BEGIN
    IF mi IS NULL THEN
        DBMS_OUTPUT.PUT_LINE(first || ' ' || last);
    ELSE
        DBMS_OUTPUT.PUT_LINE(first || ' ' || mi || '. ' || last);
    END IF;
END print_name;
/

```

Invoke procedure:

```

BEGIN
    print_name('John', 'Doe');           -- original invocation
    print_name('John', 'Public', 'Q');  -- new invocation
END;
/

```

Result:

```

John Doe
John Q. Public

```

8.7.6 Positional, Named, and Mixed Notation for Actual Parameters

When invoking a subprogram, you can specify the actual parameters using either positional, named, or mixed notation. [Table 8-3](#) summarizes and compares these notations.

Table 8-3 PL/SQL Actual Parameter Notations

Notation	Syntax	Optional parameters	Advantages	Disadvantages
Positional	Specify the actual parameters in the same order as the formal parameters are declared.	You can omit trailing optional parameters.		<p>Specifying actual parameters in the wrong order can cause problems that are hard to detect, especially if the actual parameters are literals.</p> <p>Subprogram invocations must change if the formal parameter list changes, unless the list only acquires new trailing optional parameters (as in Example 8-22).</p> <p>Reduced code clarity and maintainability. Not recommended if the subprogram has a large number of parameters.</p>

Table 8-3 (Cont.) PL/SQL Actual Parameter Notations

Notation	Syntax	Optional parameters	Advantages	Disadvantages
Named	Specify the actual parameters in any order, using this syntax: <i>formal => actual</i> <i>formal</i> is the name of the formal parameter and <i>actual</i> is the actual parameter.	You can omit any optional parameters.	There is no wrong order for specifying actual parameters. Subprogram invocations must change only if the formal parameter list acquires new required parameters. Recommended when you invoke a subprogram defined or maintained by someone else.	
Mixed	Start with positional notation, then use named notation for the remaining parameters.	In the positional notation, you can omit trailing optional parameters; in the named notation, you can omit any optional parameters.	Convenient when you invoke a subprogram that has required parameters followed by optional parameters, and you must specify only a few of the optional parameters.	In the positional notation, the wrong order can cause problems that are hard to detect, especially if the actual parameters are literals. Changes to the formal parameter list might require changes in the positional notation.

In [Example 8-23](#), the procedure invocations use different notations, but are equivalent.

In [Example 8-24](#), the SQL `SELECT` statements invoke the PL/SQL function `compute_bonus`, using equivalent invocations with different notations.

Example 8-23 Equivalent Invocations with Different Notations in Anonymous Block

```

DECLARE
    emp_num NUMBER(6) := 120;
    bonus   NUMBER(6) := 50;

    PROCEDURE raise_salary (
        emp_id NUMBER,
        amount NUMBER
    ) IS
    BEGIN
        UPDATE employees
        SET salary = salary + amount
        WHERE employee_id = emp_id;
    END raise_salary;

BEGIN
    -- Equivalent invocations:

    raise_salary(emp_num, bonus);           -- positional notation
    raise_salary(amount => bonus, emp_id => emp_num); -- named notation
    raise_salary(emp_id => emp_num, amount => bonus); -- named notation
    raise_salary(emp_num, amount => bonus); -- mixed notation

```

```
END;  
/
```

Example 8-24 Equivalent Invocations with Different Notations in SELECT Statements

```
CREATE OR REPLACE FUNCTION compute_bonus (  
    emp_id NUMBER,  
    bonus NUMBER  
) RETURN NUMBER  
    AUTHID DEFINER  
IS  
    emp_sal NUMBER;  
BEGIN  
    SELECT salary INTO emp_sal  
    FROM employees  
    WHERE employee_id = emp_id;  
  
    RETURN emp_sal + bonus;  
END compute_bonus;  
/  
SELECT compute_bonus(120, 50) FROM DUAL;           -- positional  
SELECT compute_bonus(bonus => 50, emp_id => 120) FROM DUAL; -- named  
SELECT compute_bonus(120, bonus => 50) FROM DUAL;   -- mixed
```

8.8 Subprogram Invocation Resolution

When the PL/SQL compiler encounters a subprogram invocation, it searches for a matching subprogram declaration—first in the current scope and then, if necessary, in successive enclosing scopes.

A declaration and invocation match if their subprogram names and parameter lists match. The parameter lists match if each required formal parameter in the declaration has a corresponding actual parameter in the invocation.

If the compiler finds no matching declaration for an invocation, then it generates a semantic error.

[Figure 8-1](#) shows how the PL/SQL compiler resolves a subprogram invocation.

Figure 8-1 How PL/SQL Compiler Resolves Invocations

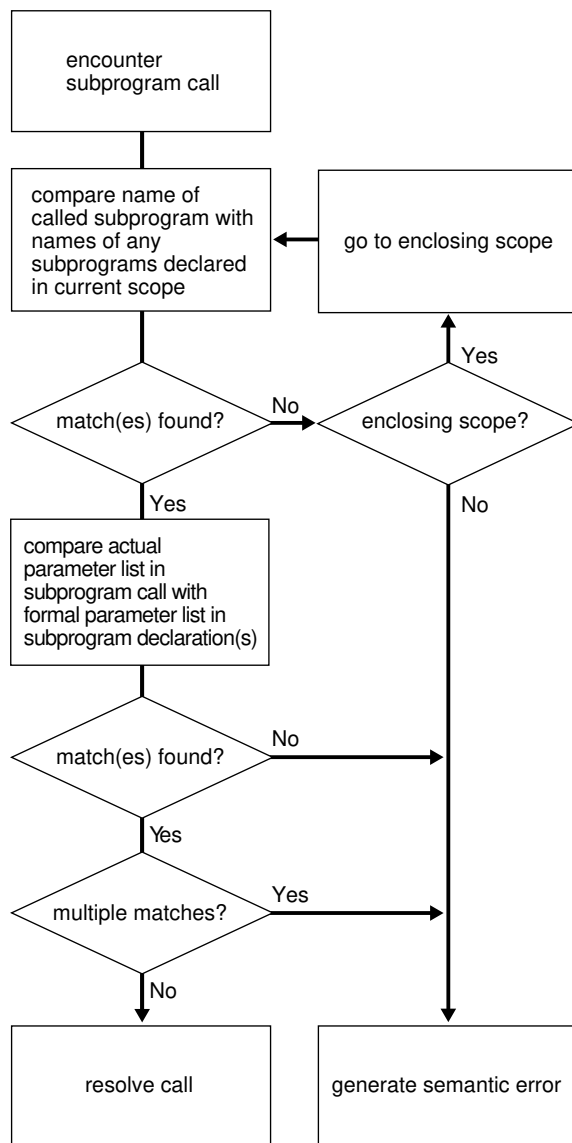

In [Example 8-25](#), the function `balance` tries to invoke the enclosing procedure `swap`, using appropriate actual parameters. However, `balance` contains two nested procedures named `swap`, and neither has parameters of the same type as the enclosing procedure `swap`. Therefore, the invocation causes compilation error PLS-00306.

Example 8-25 Resolving PL/SQL Procedure Names

```

DECLARE
  PROCEDURE swap (
    n1 NUMBER,
    n2 NUMBER
  )
  IS
    num1 NUMBER;
    num2 NUMBER;

  FUNCTION balance

```

```
(bal NUMBER)
RETURN NUMBER
IS
  x NUMBER := 10;

  PROCEDURE swap (
    d1 DATE,
    d2 DATE
  ) IS
  BEGIN
    NULL;
  END;

  PROCEDURE swap (
    b1 BOOLEAN,
    b2 BOOLEAN
  ) IS
  BEGIN
    NULL;
  END;

BEGIN -- balance
  swap(num1, num2);
  RETURN x;
END balance;

BEGIN -- enclosing procedure swap
  NULL;
END swap;

BEGIN -- anonymous block
  NULL;
END; -- anonymous block
/
```

Result:

```
swap(num1, num2);
*
ERROR at line 33:
ORA-06550: line 33, column 7:
PLS-00306: wrong number or types of arguments in call to 'SWAP'
ORA-06550: line 33, column 7:
PL/SQL: Statement ignored
```

8.9 Overloaded Subprograms

PL/SQL lets you overload nested subprograms, package subprograms, and type methods. You can use the same name for several different subprograms if their formal parameters differ in name, number, order, or data type family. (A **data type family** is a data type and its subtypes. For the data type families of predefined PL/SQL data types, see [PL/SQL Predefined Data Types](#). For information about user-defined PL/SQL subtypes, see "[User-Defined PL/SQL Subtypes](#)".) If formal parameters differ only in name, then you must use named notation to specify the corresponding actual parameters. (For information about named notation, see "[Positional, Named, and Mixed Notation for Actual Parameters](#)".)

[Example 8-26](#) defines two subprograms with the same name, `initialize`. The procedures `initialize` different types of collections. Because the processing in the procedures is the same, it is logical to give them the same name.

You can put the two `initialize` procedures in the same block, subprogram, package, or type body. PL/SQL determines which procedure to invoke by checking their formal parameters. The version of `initialize` that PL/SQL uses depends on whether you invoke the procedure with a `date_tab_typ` or `num_tab_typ` parameter.

For an example of an overloaded procedure in a package, see [Example 10-9](#).

Topics

- [Formal Parameters that Differ Only in Numeric Data Type](#)
- [Subprograms that You Cannot Overload](#)
- [Subprogram Overload Errors](#)

Example 8-26 Overloaded Subprogram

```

DECLARE
  TYPE date_tab_typ IS TABLE OF DATE INDEX BY PLS_INTEGER;
  TYPE num_tab_typ IS TABLE OF NUMBER INDEX BY PLS_INTEGER;

  hiredate_tab date_tab_typ;
  sal_tab      num_tab_typ;

  PROCEDURE initialize (tab OUT date_tab_typ, n INTEGER) IS
  BEGIN
    DBMS_OUTPUT.PUT_LINE('Invoked first version');
    FOR i IN 1..n LOOP
      tab(i) := SYSDATE;
    END LOOP;
  END initialize;

  PROCEDURE initialize (tab OUT num_tab_typ, n INTEGER) IS
  BEGIN
    DBMS_OUTPUT.PUT_LINE('Invoked second version');
    FOR i IN 1..n LOOP
      tab(i) := 0.0;
    END LOOP;
  END initialize;

BEGIN
  initialize(hiredate_tab, 50);
  initialize(sal_tab, 100);
END;
/

```

Result:

```

Invoked first version
Invoked second version

```

8.9.1 Formal Parameters that Differ Only in Numeric Data Type

You can overload subprograms if their formal parameters differ only in numeric data type. This technique is useful in writing mathematical application programming interfaces (APIs), because several versions of a function can use the same name, and each can accept a

different numeric type. For example, a function that accepts `BINARY_FLOAT` might be faster, while a function that accepts `BINARY_DOUBLE` might be more precise.

To avoid problems or unexpected results when passing parameters to such overloaded subprograms:

- Ensure that the expected version of a subprogram is invoked for each set of expected parameters.

For example, if you have overloaded functions that accept `BINARY_FLOAT` and `BINARY_DOUBLE`, which is invoked if you pass a `VARCHAR2` literal like `'5.0'`?

- Qualify numeric literals and use conversion functions to make clear what the intended parameter types are.

For example, use literals such as `5.0f` (for `BINARY_FLOAT`), `5.0d` (for `BINARY_DOUBLE`), or conversion functions such as `TO_BINARY_FLOAT`, `TO_BINARY_DOUBLE`, and `TO_NUMBER`.

PL/SQL looks for matching numeric parameters in this order:

1. `PLS_INTEGER` (or `BINARY_INTEGER`, an identical data type)
2. `NUMBER`
3. `BINARY_FLOAT`
4. `BINARY_DOUBLE`

A `VARCHAR2` value can match a `NUMBER`, `BINARY_FLOAT`, or `BINARY_DOUBLE` parameter.

PL/SQL uses the first overloaded subprogram that matches the supplied parameters. For example, the `SQRT` function takes a single parameter. There are overloaded versions that accept a `NUMBER`, a `BINARY_FLOAT`, or a `BINARY_DOUBLE` parameter. If you pass a `PLS_INTEGER` parameter, the first matching overload is the one with a `NUMBER` parameter.

The `SQRT` function that takes a `NUMBER` parameter is likely to be slowest. To use a faster version, use the `TO_BINARY_FLOAT` or `TO_BINARY_DOUBLE` function to convert the parameter to another data type before passing it to the `SQRT` function.

If PL/SQL must convert a parameter to another data type, it first tries to convert it to a higher data type. For example:

- The `ATAN2` function takes two parameters of the same type. If you pass parameters of different types—for example, one `PLS_INTEGER` and one `BINARY_FLOAT`—PL/SQL tries to find a match where both parameters use the higher type. In this case, that is the version of `ATAN2` that takes two `BINARY_FLOAT` parameters; the `PLS_INTEGER` parameter is converted upwards.
- A function takes two parameters of different types. One overloaded version takes a `PLS_INTEGER` and a `BINARY_FLOAT` parameter. Another overloaded version takes a `NUMBER` and a `BINARY_DOUBLE` parameter. If you invoke this function and pass two `NUMBER` parameters, PL/SQL first finds the overloaded version where the second parameter is `BINARY_FLOAT`. Because this parameter is a closer match than the `BINARY_DOUBLE` parameter in the other overload, PL/SQL then looks downward and converts the first `NUMBER` parameter to `PLS_INTEGER`.

8.9.2 Subprograms that You Cannot Overload

You cannot overload these subprograms:

- Standalone subprograms
- Subprograms whose formal parameters differ only in mode; for example:

```
PROCEDURE s (p IN VARCHAR2) IS ...
PROCEDURE s (p OUT VARCHAR2) IS ...
```

- Subprograms whose formal parameters differ only in subtype; for example:

```
PROCEDURE s (p INTEGER) IS ...
PROCEDURE s (p REAL) IS ...
```

`INTEGER` and `REAL` are subtypes of `NUMBER`, so they belong to the same data type family.

- Functions that differ only in return value data type, even if the data types are in different families; for example:

```
FUNCTION f (p INTEGER) RETURN BOOLEAN IS ...
FUNCTION f (p INTEGER) RETURN INTEGER IS ...
```

8.9.3 Subprogram Overload Errors

The PL/SQL compiler catches overload errors as soon as it determines that it cannot tell which subprogram was invoked. When subprograms have identical headings, the compiler catches the overload error when you try to compile the subprograms themselves (if they are nested) or when you try to compile the package specification that declares them. Otherwise, the compiler catches the error when you try to compile an ambiguous invocation of a subprogram.

When you try to compile the package specification in [Example 8-27](#), which declares subprograms with identical headings, you get compile-time error PLS-00305.

Although the package specification in [Example 8-28](#) violates the rule that you cannot overload subprograms whose formal parameters differ only in subtype, you can compile it without error.

However, when you try to compile an invocation of `pkg2.s`, as in [Example 8-29](#), you get compile-time error PLS-00307.

Suppose that you correct the overload error in [Example 8-28](#) by giving the formal parameters of the overloaded subprograms different names, as in [Example 8-30](#).

Now you can compile an invocation of `pkg2.s` without error if you specify the actual parameter with named notation, as in [Example 8-31](#). (If you specify the actual parameter with positional notation, as in [Example 8-29](#), you still get compile-time error PLS-00307.)

The package specification in [Example 8-32](#) violates no overload rules and compiles without error. However, you can still get compile-time error PLS-00307 when invoking its overloaded procedure, as in the second invocation in [Example 8-33](#).

When trying to determine which subprogram was invoked, if the PL/SQL compiler implicitly converts one parameter to a matching type, then the compiler looks for other parameters that it can implicitly convert to matching types. If there is more than one match, then compile-time error PLS-00307 occurs, as in [Example 8-34](#).

Example 8-27 Overload Error Causes Compile-Time Error

```
CREATE OR REPLACE PACKAGE pkg1 AUTHID DEFINER IS
  PROCEDURE s (p VARCHAR2);
  PROCEDURE s (p VARCHAR2);
END pkg1;
/
```

Example 8-28 Overload Error Compiles Successfully

```
CREATE OR REPLACE PACKAGE pkg2 AUTHID DEFINER IS
  SUBTYPE t1 IS VARCHAR2(10);
  SUBTYPE t2 IS VARCHAR2(10);
  PROCEDURE s (p t1);
  PROCEDURE s (p t2);
END pkg2;
/
```

Example 8-29 Invoking Subprogram in [Example 8-28](#) Causes Compile-Time Error

```
CREATE OR REPLACE PROCEDURE p AUTHID DEFINER IS
  a pkg2.t1 := 'a';
BEGIN
  pkg2.s(a); -- Causes compile-time error PLS-00307
END p;
/
```

Example 8-30 Correcting Overload Error in [Example 8-28](#)

```
CREATE OR REPLACE PACKAGE pkg2 AUTHID DEFINER IS
  SUBTYPE t1 IS VARCHAR2(10);
  SUBTYPE t2 IS VARCHAR2(10);
  PROCEDURE s (p1 t1);
  PROCEDURE s (p2 t2);
END pkg2;
/
```

Example 8-31 Invoking Subprogram in [Example 8-30](#)

```
CREATE OR REPLACE PROCEDURE p AUTHID DEFINER IS
  a pkg2.t1 := 'a';
BEGIN
  pkg2.s(p1=>a); -- Compiles without error
END p;
/
```

Example 8-32 Package Specification Without Overload Errors

```
CREATE OR REPLACE PACKAGE pkg3 AUTHID DEFINER IS
  PROCEDURE s (p1 VARCHAR2);
  PROCEDURE s (p1 VARCHAR2, p2 VARCHAR2 := 'p2');
END pkg3;
/
```

Example 8-33 Improper Invocation of Properly Overloaded Subprogram

```
CREATE OR REPLACE PROCEDURE p AUTHID DEFINER IS
  a1 VARCHAR2(10) := 'a1';
  a2 VARCHAR2(10) := 'a2';
BEGIN
  pkg3.s(p1=>a1, p2=>a2); -- Compiles without error
END;
```



```

    pkg3.s(p1=>a1);          -- Causes compile-time error PLS-00307
END p;
/

```

Example 8-34 Implicit Conversion of Parameters Causes Overload Error

```

CREATE OR REPLACE PACKAGE pack1 AUTHID DEFINER AS
    PROCEDURE procl (a NUMBER, b VARCHAR2);
    PROCEDURE procl (a NUMBER, b NUMBER);
END;
/
CREATE OR REPLACE PACKAGE BODY pack1 AS
    PROCEDURE procl (a NUMBER, b VARCHAR2) IS BEGIN NULL; END;
    PROCEDURE procl (a NUMBER, b NUMBER) IS BEGIN NULL; END;
END;
/
BEGIN
    pack1.procl(1, '2');    -- Compiles without error
    pack1.procl(1,2);      -- Compiles without error
    pack1.procl('1', '2'); -- Causes compile-time error PLS-00307
    pack1.procl('1',2);    -- Causes compile-time error PLS-00307
END;
/

```

8.10 Recursive Subprograms

A **recursive subprogram** invokes itself. Recursion is a powerful technique for simplifying an algorithm.

A recursive subprogram must have at least two execution paths—one leading to the recursive invocation and one leading to a terminating condition. Without the latter, recursion continues until PL/SQL runs out of memory and raises the predefined exception `STORAGE_ERROR`.

In [Example 8-35](#), the function implements the following recursive definition of n factorial ($n!$), the product of all integers from 1 to n :

$$n! = n * (n - 1)!$$

In [Example 8-36](#), the function returns the n th Fibonacci number, which is the sum of the $n-1$ st and $n-2$ nd Fibonacci numbers. The first and second Fibonacci numbers are zero and one, respectively.

Note:

The function in [Example 8-36](#) is a good candidate for result caching. For more information, see "[Result-Cached Recursive Function](#)".

Each recursive invocation of a subprogram creates an instance of each item that the subprogram declares and each SQL statement that it executes.

A recursive invocation inside a cursor `FOR LOOP` statement, or between an `OPEN` or `OPEN FOR` statement and a `CLOSE` statement, opens another cursor at each invocation, which might cause the number of open cursors to exceed the limit set by the database initialization parameter `OPEN_CURSORS`.

Example 8-35 Recursive Function Returns n Factorial (n!)

```

CREATE OR REPLACE FUNCTION factorial (
  n POSITIVE
) RETURN POSITIVE
  AUTHID DEFINER
IS
BEGIN
  IF n = 1 THEN                -- terminating condition
    RETURN n;
  ELSE
    RETURN n * factorial(n-1); -- recursive invocation
  END IF;
END;
/
BEGIN
  FOR i IN 1..5 LOOP
    DBMS_OUTPUT.PUT_LINE(i || '! = ' || factorial(i));
  END LOOP;
END;
/

```

Result:

```

1! = 1
2! = 2
3! = 6
4! = 24
5! = 120

```

Example 8-36 Recursive Function Returns nth Fibonacci Number

```

CREATE OR REPLACE FUNCTION fibonacci (
  n PLS_INTEGER
) RETURN PLS_INTEGER
  AUTHID DEFINER
IS
  fib_1 PLS_INTEGER := 0;
  fib_2 PLS_INTEGER := 1;
BEGIN
  IF n = 1 THEN                -- terminating condition
    RETURN fib_1;
  ELSIF n = 2 THEN             -- terminating condition
    RETURN fib_2;
  ELSE
    RETURN fibonacci(n-2) + fibonacci(n-1); -- recursive invocations
  END IF;
END;
/
BEGIN
  FOR i IN 1..10 LOOP
    DBMS_OUTPUT.PUT(fibonacci(i));
    IF i < 10 THEN
      DBMS_OUTPUT.PUT(', ');
    END IF;
  END LOOP;

  DBMS_OUTPUT.PUT_LINE(' ...');
END;
/

```

Result:

0, 1, 1, 2, 3, 5, 8, 13, 21, 34 ...

8.11 Subprogram Side Effects

A subprogram has side effects if it changes anything except the values of its own local variables. For example, a subprogram that changes any of the following has side effects:

- Its own `OUT` or `IN OUT` parameter
- A global variable
- A public variable in a package
- A database table
- The database
- The external state (by invoking `DBMS_OUTPUT` or sending e-mail, for example)

Side effects can prevent the parallelization of a query, yield order-dependent (and therefore, indeterminate) results, or require that package state be maintained across user sessions.

Minimizing side effects is especially important when defining a result-cached function or a stored function for SQL statements to invoke.



See Also:

Oracle Database Development Guide for information about controlling side effects in PL/SQL functions invoked from SQL statements

8.12 PL/SQL Function Result Cache

When a PL/SQL function has the `RESULT_CACHE` option, its results are cached in the shared global area (SGA) so sessions connected to the same instance can reuse these results when available.

Oracle Database automatically detects all data sources (tables and views) that are queried while a result-cached function is running. If changes to any of these data sources are committed, the cached result becomes invalid across all instances. The best candidates for result-caching are functions that are invoked frequently but depend on information that changes infrequently or never.

Topics

- [Enabling Result-Caching for a Function](#)
- [Developing Applications with Result-Cached Functions](#)
- [Requirements for Result-Cached Functions](#)
- [Examples of Result-Cached Functions](#)
- [Advanced Result-Cached Function Topics](#)

8.12.1 Enabling Result-Caching for a Function

To make a function result-cached, include the `RESULT_CACHE` clause in the function declaration and definition. For syntax details, see "[Function Declaration and Definition](#)".

Note:

For more information about configuring and managing the database server result cache, see *Oracle Database Reference* and *Oracle Database Performance Tuning Guide*.

In [Example 8-37](#), the package `department_pkg` declares and then defines a result-cached function, `get_dept_info`, which returns a record of information about a given department. The function depends on the database tables `DEPARTMENTS` and `EMPLOYEES`.

You invoke the function `get_dept_info` as you invoke any function. For example, this invocation returns a record of information about department number 10:

```
department_pkg.get_dept_info(10);
```

This invocation returns only the name of department number 10:

```
department_pkg.get_dept_info(10).dept_name;
```

If the result for `get_dept_info(10)` is in the result cache, the result is returned from the cache; otherwise, the result is computed and added to the cache. Because `get_dept_info` depends on the `DEPARTMENTS` and `EMPLOYEES` tables, any committed change to `DEPARTMENTS` or `EMPLOYEES` invalidates all cached results for `get_dept_info`, relieving you of programming cache invalidation logic everywhere that `DEPARTMENTS` or `EMPLOYEES` might change.

Example 8-37 Declaring and Defining Result-Cached Function

```
CREATE OR REPLACE PACKAGE department_pkg AUTHID DEFINER IS

    TYPE dept_info_record IS RECORD (
        dept_name departments.department_name%TYPE,
        mgr_name employees.last_name%TYPE,
        dept_size PLS_INTEGER
    );

    -- Function declaration

    FUNCTION get_dept_info (dept_id NUMBER)
        RETURN dept_info_record
        RESULT_CACHE;

END department_pkg;
/
CREATE OR REPLACE PACKAGE BODY department_pkg IS
    -- Function definition
    FUNCTION get_dept_info (dept_id NUMBER)
```

```

RETURN dept_info_record
RESULT_CACHE
IS
  rec dept_info_record;
BEGIN
  SELECT department_name INTO rec.dept_name
  FROM departments
  WHERE department_id = dept_id;

  SELECT e.last_name INTO rec.mgr_name
  FROM departments d, employees e
  WHERE d.department_id = dept_id
  AND d.manager_id = e.employee_id;

  SELECT COUNT(*) INTO rec.dept_size
  FROM EMPLOYEES
  WHERE department_id = dept_id;

RETURN rec;
END get_dept_info;
END department_pkg;
/

```

8.12.2 Developing Applications with Result-Cached Functions

When developing an application that uses a result-cached function, make no assumptions about the number of times the body of the function will run for a given set of parameter values.

Some situations in which the body of a result-cached function runs are:

- The first time a session on this database instance invokes the function with these parameter values
- When the cached result for these parameter values is **invalid**
When a change to any data source on which the function depends is committed, the cached result becomes invalid.
- When the cached results for these parameter values have aged out
If the system needs memory, it might discard the oldest cached values.
- When the function bypasses the cache (see "[Result Cache Bypass](#)")

8.12.3 Requirements for Result-Cached Functions

A result-cached PL/SQL function is safe if it always produces the same output for any input that it would produce were it not marked with `RESULT_CACHE`. This safety is only guaranteed if these conditions are met:

- When the function is executed, it has no side effects.
For information about side effects, see "[Subprogram Side Effects](#)".
- All tables that the function accesses are ordinary, non-SYS-owned permanent tables in the same database as the function.
- The function's result must be determined only by the vector of input actuals together with the committed content, at the current `SCN`, of the tables that it references.

It is recommended that a result-cached function also meet these criteria:

- It does not depend on session-specific settings.
For more information, see "[Making Result-Cached Functions Handle Session-Specific Settings](#)".
- It does not depend on session-specific application contexts.
For more information, see "[Making Result-Cached Functions Handle Session-Specific Application Contexts](#)".

For more information, see *Oracle Database Performance Tuning Guide*.

8.12.4 Examples of Result-Cached Functions

The best candidates for result-caching are functions that are invoked frequently but depend on information that changes infrequently (as might be the case in the first example). Result-caching avoids redundant computations in recursive functions.

Examples:

- [Result-Cached Application Configuration Parameters](#)
- [Result-Cached Recursive Function](#)

8.12.4.1 Result-Cached Application Configuration Parameters

Consider an application that has configuration parameters that can be set at either the global level, the application level, or the role level. The application stores the configuration information in these tables:

```
-- Global Configuration Settings
DROP TABLE global_config_params;
CREATE TABLE global_config_params
  (name VARCHAR2(20), -- parameter NAME
   val VARCHAR2(20), -- parameter VALUE
   PRIMARY KEY (name)
  );

-- Application-Level Configuration Settings
CREATE TABLE app_level_config_params
  (app_id VARCHAR2(20), -- application ID
   name VARCHAR2(20), -- parameter NAME
   val VARCHAR2(20), -- parameter VALUE
   PRIMARY KEY (app_id, name)
  );

-- Role-Level Configuration Settings
CREATE TABLE role_level_config_params
  (role_id VARCHAR2(20), -- application (role) ID
   name VARCHAR2(20), -- parameter NAME
   val VARCHAR2(20), -- parameter VALUE
   PRIMARY KEY (role_id, name)
  );
```

For each configuration parameter, the role-level setting overrides the application-level setting, which overrides the global setting. To determine which setting applies to a parameter, the application defines the PL/SQL function `get_value`. Given a parameter name, application ID, and role ID, `get_value` returns the setting that applies to the parameter.

The function `get_value` is a good candidate for result-caching if it is invoked frequently and if the configuration information changes infrequently.

Example 8-38 shows a possible definition for `get_value`. Suppose that for one set of parameter values, the global setting determines the result of `get_value`. While `get_value` is running, the database detects that three tables are queried—`role_level_config_params`, `app_level_config_params`, and `global_config_params`. If a change to any of these three tables is committed, the cached result for this set of parameter values is invalidated and must be recomputed.

Now suppose that, for a second set of parameter values, the role-level setting determines the result of `get_value`. While `get_value` is running, the database detects that only the `role_level_config_params` table is queried. If a change to `role_level_config_params` is committed, the cached result for the second set of parameter values is invalidated; however, committed changes to `app_level_config_params` or `global_config_params` do not affect the cached result.

Example 8-38 Result-Cached Function Returns Configuration Parameter Setting

```
CREATE OR REPLACE FUNCTION get_value
  (p_param VARCHAR2,
   p_app_id NUMBER,
   p_role_id NUMBER
  )
  RETURN VARCHAR2
  RESULT_CACHE
  AUTHID DEFINER
IS
  answer VARCHAR2(20);
BEGIN
  -- Is parameter set at role level?
  BEGIN
    SELECT val INTO answer
      FROM role_level_config_params
      WHERE role_id = p_role_id
            AND name = p_param;
    RETURN answer; -- Found
  EXCEPTION
    WHEN no_data_found THEN
      NULL; -- Fall through to following code
  END;
  -- Is parameter set at application level?
  BEGIN
    SELECT val INTO answer
      FROM app_level_config_params
      WHERE app_id = p_app_id
            AND name = p_param;
    RETURN answer; -- Found
  EXCEPTION
    WHEN no_data_found THEN
      NULL; -- Fall through to following code
  END;
  -- Is parameter set at global level?
  SELECT val INTO answer
    FROM global_config_params
    WHERE name = p_param;
  RETURN answer;
END;
```

8.12.4.2 Result-Cached Recursive Function

A recursive function for finding the n th term of a Fibonacci series that mirrors the mathematical definition of the series might do many redundant computations. For example, to evaluate `fibonacci(7)`, the function must compute `fibonacci(6)` and `fibonacci(5)`. To compute `fibonacci(6)`, the function must compute `fibonacci(5)` and `fibonacci(4)`. Therefore, `fibonacci(5)` and several other terms are computed redundantly. Result-caching avoids these redundant computations.

 **Note:**

The maximum number of recursive invocations cached is 128.

```
CREATE OR REPLACE FUNCTION fibonacci (n NUMBER)
RETURN NUMBER
  RESULT_CACHE
  AUTHID DEFINER
IS
BEGIN
  IF (n =0) OR (n =1) THEN
    RETURN 1;
  ELSE
    RETURN fibonacci(n - 1) + fibonacci(n - 2);
  END IF;
END;
/
```

8.12.5 Advanced Result-Cached Function Topics

Topics

- [Rules for a Cache Hit](#)
- [Result Cache Bypass](#)
- [Making Result-Cached Functions Handle Session-Specific Settings](#)
- [Making Result-Cached Functions Handle Session-Specific Application Contexts](#)
- [Choosing Result-Caching Granularity](#)
- [Result Caches in Oracle RAC Environment](#)
- [Result Cache Management](#)
- [Hot-Patching PL/SQL Units on Which Result-Cached Functions Depend](#)

8.12.5.1 Rules for a Cache Hit

Each time a result-cached function is invoked with different parameter values, those parameters and their result are stored in the cache. Subsequently, when the same function is invoked with the same parameter values (that is, when there is a **cache hit**), the result is retrieved from the cache, instead of being recomputed.

The rules for parameter comparison for a cache hit differ from the rules for the PL/SQL "equal to" (=) operator, as follows:

Category	Cache Hit Rules	"Equal To" Operator Rules
NULL comparison	NULL equals NULL	NULL = NULL evaluates to NULL.
Non-null scalar comparison	Non-null scalars are the same if and only if their values are identical; that is, if and only if their values have identical bit patterns on the given platform. For example, CHAR values 'AA' and 'AA ' are different. (This rule is stricter than the rule for the "equal to" operator.)	Non-null scalars can be equal even if their values do not have identical bit patterns on the given platform; for example, CHAR values 'AA' and 'AA ' are equal.

8.12.5.2 Result Cache Bypass

In some situations, the cache is bypassed. When the cache is bypassed:

- The function computes the result instead of retrieving it from the cache.
- The result that the function computes is not added to the cache.

Some examples of situations in which the cache is bypassed are:

- The cache is unavailable to all sessions.

For example, the database administrator has disabled the use of the result cache during application patching (as in "[Hot-Patching PL/SQL Units on Which Result-Cached Functions Depend](#)").

- A session is performing a DML statement on a table or view on which a result-cached function depends.

The session bypasses the result cache for that function until the DML statement is completed—either committed or rolled back. If the statement is rolled back, the session resumes using the cache for that function.

Cache bypass ensures that:

- The user of each session sees his or her own uncommitted changes.
- The PL/SQL function result cache has only committed changes that are visible to all sessions, so that uncommitted changes in one session are not visible to other sessions.

8.12.5.3 Making Result-Cached Functions Handle Session-Specific Settings

If a function depends on settings that might vary from session to session (such as `NLS_DATE_FORMAT` and `TIME_ZONE`), make the function result-cached only if you can modify it to handle the various settings.

The function, `get_hire_date`, in Example 8–39 uses the `TO_CHAR` function to convert a `DATE` item to a `VARCHAR` item. The function `get_hire_date` does not specify a format mask, so the format mask defaults to the one that `NLS_DATE_FORMAT` specifies. If sessions that invoke `get_hire_date` have different `NLS_DATE_FORMAT` settings, cached results can have different formats. If a cached result computed by one session ages out, and another session recomputes it, the format might vary even for the same parameter value. If a session gets a cached result whose format differs from its own format, that result is probably incorrect.

Some possible solutions to this problem are:

- Change the return type of `get_hire_date` to `DATE` and have each session invoke the `TO_CHAR` function.
- If a common format is acceptable to all sessions, specify a format mask, removing the dependency on `NLS_DATE_FORMAT`. For example:

```
TO_CHAR(date_hired, 'mm/dd/yy');
```

- Add a format mask parameter to `get_hire_date`. For example:

```
CREATE OR REPLACE FUNCTION get_hire_date (emp_id NUMBER, fmt VARCHAR)
  RETURN VARCHAR
  RESULT_CACHE
  AUTHID DEFINER
IS
  date_hired DATE;
BEGIN
  SELECT hire_date INTO date_hired
    FROM HR.EMPLOYEES
     WHERE EMPLOYEE_ID = emp_id;
  RETURN TO_CHAR(date_hired, fmt);
END;
/
```

Example 8-39 Result-Cached Function Handles Session-Specific Settings

```
CREATE OR REPLACE FUNCTION get_hire_date (emp_id NUMBER)
  RETURN VARCHAR
  RESULT_CACHE
  AUTHID DEFINER
IS
  date_hired DATE;
BEGIN
  SELECT hire_date INTO date_hired
    FROM HR.EMPLOYEES
     WHERE EMPLOYEE_ID = emp_id;
  RETURN TO_CHAR(date_hired);
END;
/
```

8.12.5.4 Making Result-Cached Functions Handle Session-Specific Application Contexts

An **application context**, which can be either global or session-specific, is a set of attributes and their values. A PL/SQL function depends on session-specific application contexts if it does one or more of the following:

- Directly invokes the SQL function `SYS_CONTEXT`, which returns the value of a specified attribute in a specified context
- Indirectly invokes `SYS_CONTEXT` by using Virtual Private Database (VPD) mechanisms for fine-grained security

(For information about VPD, see *Oracle Database Security Guide*.)

The PL/SQL function result-caching feature does not automatically handle dependence on session-specific application contexts. If you must cache the results of a function that depends on session-specific application contexts, you must pass the

application context to the function as a parameter. You can give the parameter a default value, so that not every user must specify it.

In [Example 8-40](#), assume that a table, `config_tab`, has a VPD policy that translates this query:

```
SELECT value FROM config_tab WHERE name = param_name;
```

To this query:

```
SELECT value FROM config_tab
WHERE name = param_name
AND app_id = SYS_CONTEXT('Config', 'App_ID');
```

Example 8-40 Result-Cached Function Handles Session-Specific Application Context

```
CREATE OR REPLACE FUNCTION get_param_value (
  param_name VARCHAR,
  appctx      VARCHAR  DEFAULT SYS_CONTEXT('Config', 'App_ID')
) RETURN VARCHAR
  RESULT_CACHE
  AUTHID DEFINER
IS
  rec VARCHAR(2000);
BEGIN
  SELECT val INTO rec
  FROM config_tab
  WHERE name = param_name;

  RETURN rec;
END;
/
```

8.12.5.5 Choosing Result-Caching Granularity

PL/SQL provides the function result cache, but you choose the caching granularity. To understand the concept of granularity, consider the `Product_Descriptions` table in the Order Entry (OE) sample schema:

NAME	NULL?	TYPE
PRODUCT_ID	NOT NULL	NUMBER(6)
LANGUAGE_ID	NOT NULL	VARCHAR2(3)
TRANSLATED_NAME	NOT NULL	NVARCHAR2(50)
TRANSLATED_DESCRIPTION	NOT NULL	NVARCHAR2(2000)

The table has the name and description of each product in several languages. The unique key for each row is `PRODUCT_ID`, `LANGUAGE_ID`.

Suppose that you must define a function that takes a `PRODUCT_ID` and a `LANGUAGE_ID` and returns the associated `TRANSLATED_NAME`. You also want to cache the translated names. Some of the granularity choices for caching the names are:

- One name at a time (finer granularity)
- One language at a time (coarser granularity)

Table 8-4 Finer and Coarser Caching Granularity

Granularity	Benefits
Finer	<p>Each function result corresponds to one logical result.</p> <p>Stores only data that is needed at least once.</p> <p>Each data item ages out individually.</p> <p>Does not allow bulk loading optimizations.</p>
Coarser	<p>Each function result contains many logical subresults.</p> <p>Might store data that is never used.</p> <p>One aged-out data item ages out the whole set.</p> <p>Allows bulk loading optimizations.</p>

In [Example 8-41](#) and [Example 8-42](#), the function `productName` takes a `PRODUCT_ID` and a `LANGUAGE_ID` and returns the associated `TRANSLATED_NAME`. Each version of `productName` caches translated names, but at a different granularity.

In [Example 8-41](#), `get_product_name_1` is a result-cached function. Whenever `get_product_name_1` is invoked with a different `PRODUCT_ID` and `LANGUAGE_ID`, it caches the associated `TRANSLATED_NAME`. Each invocation of `get_product_name_1` adds at most one `TRANSLATED_NAME` to the cache.

In [Example 8-42](#), `get_product_name_2` defines a result-cached function, `all_product_names`. Whenever `get_product_name_2` invokes `all_product_names` with a different `LANGUAGE_ID`, `all_product_names` caches every `TRANSLATED_NAME` associated with that `LANGUAGE_ID`. Each invocation of `all_product_names` adds every `TRANSLATED_NAME` of at most one `LANGUAGE_ID` to the cache.

Example 8-41 Caching One Name at a Time (Finer Granularity)

```
CREATE OR REPLACE FUNCTION get_product_name_1 (
  prod_id NUMBER,
  lang_id VARCHAR2
)
  RETURN NVARCHAR2
  RESULT_CACHE
  AUTHID DEFINER
IS
  result_ VARCHAR2(50);
BEGIN
  SELECT translated_name INTO result_
  FROM OE.Product_Descriptions
  WHERE PRODUCT_ID = prod_id
  AND LANGUAGE_ID = lang_id;
  RETURN result_;
END;
/
```

Example 8-42 Caching Translated Names One Language at a Time (Coarser Granularity)

```
CREATE OR REPLACE FUNCTION get_product_name_2 (
  prod_id NUMBER,
  lang_id VARCHAR2
)
  RETURN NVARCHAR2
```

```
AUTHID DEFINER
IS
TYPE product_names IS TABLE OF NVARCHAR2(50) INDEX BY PLS_INTEGER;

FUNCTION all_product_names (lang_id VARCHAR2)
RETURN product_names
RESULT_CACHE
IS
all_names product_names;
BEGIN
FOR c IN (SELECT * FROM OE.Product_Descriptions
WHERE LANGUAGE_ID = lang_id) LOOP
all_names(c.PRODUCT_ID) := c.TRANSLATED_NAME;
END LOOP;
RETURN all_names;
END;
BEGIN
RETURN all_product_names(lang_id)(prod_id);
END;
/
```

8.12.5.6 Result Caches in Oracle RAC Environment

Cached results are stored in the system global area (SGA). In an Oracle RAC environment, each database instance manages its own local function result cache. However, the contents of the local result cache are accessible to sessions attached to other Oracle RAC instances. If a required result is missing from the result cache of the local instance, the result might be retrieved from the local cache of another instance, instead of being locally computed.

The access pattern and work load of an instance determine the set of results in its local cache; therefore, the local caches of different instances can have different sets of results.

Although each database instance might have its own set of cached results, the mechanisms for handling invalid results are Oracle RAC environment-wide. If results were invalidated only in the local instance's result cache, other instances might use invalid results. For example, consider a result cache of item prices that are computed from data in database tables. If any of these database tables is updated in a way that affects the price of an item, the cached price of that item must be invalidated in every database instance in the Oracle RAC environment.

8.12.5.7 Result Cache Management

The PL/SQL function result cache shares its administrative and manageability infrastructure with the Result Cache.

The database administrator manages the server result cache by specifying the `RESULT_CACHE_MAX_SIZE`, `RESULT_CACHE_MAX_RESULT` and `RESULT_CACHE_REMOTE_EXPIRATION` initialization parameters.

The `DBMS_RESULT_CACHE` package provides an interface to allow the DBA to administer that part of the shared pool that is used by the SQL result cache and the PL/SQL function result cache.

Dynamic performance views provide information to monitor the server and client result caches.

 **See Also:**

- *Oracle Database Reference* for more information about `RESULT_CACHE_MAX_SIZE`
- *Oracle Database Reference* for more information about `RESULT_CACHE_MAX_RESULT`
- *Oracle Database Performance Tuning Guide* for more information about result cache concepts
- *Oracle Database PL/SQL Packages and Types Reference* for more information about the `DBMS_RESULT_CACHE` package
- *Oracle Database Reference* for more information about `V$RESULT_CACHE_STATISTICS`
- *Oracle Database Reference* for more information about `V$RESULT_CACHE_MEMORY`
- *Oracle Database Reference* for more information about `V$RESULT_CACHE_OBJECTS`
- *Oracle Database Reference* for more information about `V$RESULT_CACHE_DEPENDENCY`

8.12.5.8 Hot-Patching PL/SQL Units on Which Result-Cached Functions Depend

When you hot-patch a PL/SQL unit on which a result-cached function depends (directly or indirectly), the cached results associated with the result-cached function might not be automatically flushed in all cases.

For example, suppose that the result-cached function `P1.foo()` depends on the package subprogram `P2.bar()`. If a new version of the body of package `P2` is loaded, the cached results associated with `P1.foo()` are not automatically flushed.

Therefore, this is the recommended procedure for hot-patching a PL/SQL unit:

 **Note:**

To follow these steps, you must have the `EXECUTE` privilege on the package `DBMS_RESULT_CACHE`.

1. Put the result cache in bypass mode and flush existing results:

```
BEGIN
  DBMS_RESULT_CACHE.Bypass(TRUE);
  DBMS_RESULT_CACHE.Flush;
END;
/
```

In an Oracle RAC environment, perform this step for each database instance.

2. Patch the PL/SQL code.
3. Resume using the result cache:

```
BEGIN
  DBMS_RESULT_CACHE.Bypass(FALSE);
END;
/
```

In an Oracle RAC environment, perform this step for each database instance.

8.13 PL/SQL Functions that SQL Statements Can Invoke

To be invocable from SQL statements, a stored function (and any subprograms that it invokes) must obey the following purity rules, which are meant to control side effects:

- When invoked from a `SELECT` statement or a parallelized `INSERT`, `UPDATE`, `DELETE`, or `MERGE` statement, the subprogram cannot modify any database tables.
- When invoked from an `INSERT`, `UPDATE`, `DELETE`, or `MERGE` statement, the subprogram cannot query or modify any database tables modified by that statement.

If a function either queries or modifies a table, and a DML statement on that table invokes the function, then `ORA-04091` (mutating-table error) occurs. There is one exception: `ORA-04091` does not occur if a single-row `INSERT` statement that is not in a `FORALL` statement invokes the function in a `VALUES` clause.

- When invoked from a `SELECT`, `INSERT`, `UPDATE`, `DELETE`, or `MERGE` statement, the subprogram cannot execute any of the following SQL statements (unless `PRAGMA AUTONOMOUS_TRANSACTION` was specified):
 - Transaction control statements (such as `COMMIT`)
 - Session control statements (such as `SET ROLE`)
 - System control statements (such as `ALTER SYSTEM`)
 - Database definition language (DDL) statements (such as `CREATE`), which are committed automatically

(For the description of `PRAGMA AUTONOMOUS_TRANSACTION`, see "[AUTONOMOUS_TRANSACTION Pragma](#)".)

If any SQL statement in the execution part of the function violates a rule, then a runtime error occurs when that statement is parsed.

The fewer side effects a function has, the better it can be optimized in a `SELECT` statement, especially if the function is declared with the option `DETERMINISTIC` or `PARALLEL_ENABLE` (for descriptions of these options, see "[DETERMINISTIC Clause](#)" and "[PARALLEL_ENABLE Clause](#)").

See Also:

- *Oracle Database Development Guide* for information about restrictions on PL/SQL functions that SQL statements can invoke
- "[Tune Function Invocations in Queries](#)"

8.14 Invoker's Rights and Definer's Rights (AUTHID Property)

The `AUTHID` property of a stored PL/SQL unit affects the name resolution and privilege checking of SQL statements that the unit issues at run time. The `AUTHID` property does not affect compilation, and has no meaning for units that have no code, such as collection types.

`AUTHID` property values are exposed in the static data dictionary view `*_PROCEDURES`. For units for which `AUTHID` has meaning, the view shows the value `CURRENT_USER` or `DEFINER`; for other units, the view shows `NULL`.

For stored PL/SQL units that you create or alter with the following statements, you can use the optional `AUTHID` clause to specify either `DEFINER` (the default, for backward compatibility) or `CURRENT_USER` (the preferred usage):

- "CREATE FUNCTION Statement"
- "CREATE PACKAGE Statement"
- "CREATE PROCEDURE Statement"
- "CREATE TYPE Statement"
- "ALTER TYPE Statement"

A unit whose `AUTHID` value is `CURRENT_USER` is called an **invoker's rights unit**, or **IR unit**. A unit whose `AUTHID` value is `DEFINER` (the default) is called a **definer's rights unit**, or **DR unit**. PL/SQL units and schema objects for which you cannot specify an `AUTHID` value behave like this:

PL/SQL Unit or Schema Object	Behavior
Anonymous block	IR unit
<code>BEQUEATH CURRENT_USER</code> view	Somewhat like an IR unit—see <i>Oracle Database Security Guide</i> .
<code>BEQUEATH DEFINER</code> view	DR unit
Trigger	DR unit

The `AUTHID` property of a unit determines whether the unit is IR or DR, and it affects both name resolution and privilege checking at run time:

- The context for name resolution is `CURRENT_SCHEMA`.
- The privileges checked are those of the `CURRENT_USER` and the enabled roles.

When a session starts, `CURRENT_SCHEMA` has the value of the schema owned by `SESSION_USER`, and `CURRENT_USER` has the same value as `SESSION_USER`. (To get the current value of `CURRENT_SCHEMA`, `CURRENT_USER`, or `SESSION_USER`, use the `SYS_CONTEXT` function, documented in *Oracle Database SQL Language Reference*.)

`CURRENT_SCHEMA` can be changed during the session with the SQL statement `ALTER SESSION SET CURRENT_SCHEMA`. `CURRENT_USER` cannot be changed programmatically, but it might change when a PL/SQL unit or a view is pushed onto, or popped from, the call stack.

 **Note:**

Oracle recommends against issuing `ALTER SESSION SET CURRENT_SCHEMA` from in a stored PL/SQL unit.

During a server call, when a DR unit is pushed onto the call stack, the database stores the currently enabled roles and the current values of `CURRENT_USER` and `CURRENT_SCHEMA`. It then changes both `CURRENT_USER` and `CURRENT_SCHEMA` to the owner of the DR unit, and enables only the role `PUBLIC`. (The stored and new roles and values are not necessarily different.) When the DR unit is popped from the call stack, the database restores the stored roles and values. In contrast, when an IR unit is pushed onto, or popped from, the call stack, the values of `CURRENT_USER` and `CURRENT_SCHEMA`, and the currently enabled roles do not change (unless roles are granted to the IR unit itself—see "[Granting Roles to PL/SQL Packages and Standalone Subprograms](#)").

For dynamic SQL statements issued by a PL/SQL unit, name resolution and privilege checking are done once, at run time. For static SQL statements, name resolution and privilege checking are done twice: first, when the PL/SQL unit is compiled, and then again at run time. At compile time, the `AUTHID` property has no effect—both DR and IR units are treated like DR units. At run time, however, the `AUTHID` property determines whether a unit is IR or DR, and the unit is treated accordingly.

Upon entry into an IR unit, the runtime system checks privileges before doing any initialization or running any code. If the unit owner has neither the `INHERIT PRIVILEGES` privilege on the invoker nor the `INHERIT ANY PRIVILEGES` privilege, then the runtime system raises error `ORA-06598`.

 **Note:**

If the unit owner has the required privilege, then one of these statements granted it:

```
GRANT INHERIT PRIVILEGES ON current_user TO PUBLIC
GRANT INHERIT PRIVILEGES ON current_user TO unit_owner
GRANT INHERIT ANY PRIVILEGES TO unit_owner
```

For information about the `GRANT` statement, see *Oracle Database SQL Language Reference*.

 **See Also:**

- *Oracle Database Security Guide* for information about managing security for DR and IR units
- *Oracle Database Security Guide* for information about capturing privileges that are required to compile DR and IR program units

Topics

- [Granting Roles to PL/SQL Packages and Standalone Subprograms](#)

- [IR Units Need Template Objects](#)

8.14.1 Granting Roles to PL/SQL Packages and Standalone Subprograms

Using the SQL `GRANT` command, you can grant roles to PL/SQL packages and standalone subprograms. Roles granted to a PL/SQL unit do not affect compilation. They affect the privilege checking of SQL statements that the unit issues at run time: The unit runs with the privileges of both its own roles and any other currently enabled roles.

Typically, you grant roles to an IR unit, so that users with lower privileges than yours can run the unit with only the privileges needed to do so. You grant roles to a DR unit (whose invokers run it with all your privileges) only if the DR unit issues dynamic SQL, which is checked only at run time.

The basic syntax for granting roles to PL/SQL units is:

```
GRANT role [, role ]... TO unit [, unit ]...
```

For example, this command grants the roles `read` and `execute` to the function `scott.func` and the package `sys.pkg`:

```
GRANT read, execute TO FUNCTION scott.func, PACKAGE sys.pkg
```

For the complete syntax and semantics of the `GRANT` command, see *Oracle Database SQL Language Reference*.

See Also:

- *Oracle Database SQL Language Reference* for information about the `REVOKE` command, which lets you revoke roles from PL/SQL units
- *Oracle Database Security Guide* for more information about configuring application users and application roles

8.14.2 IR Units Need Template Objects

One user (that is, one schema) owns an IR unit and other users run it in their schemas. If the IR unit issues static SQL statements, then the schema objects that these statements affect must exist in the owner's schema at compile time (so that the compiler can resolve references) and in the invoker's schema at run time. The definitions of corresponding schema objects must match (for example, corresponding tables must have the same names and columns); otherwise, you get an error or unexpected results. However, the objects in the owner's schema need not contain data, because the compiler does not need it; therefore, they are called **template objects**.

8.14.3 Connected User Database Links in DR Units

If you include a connected user database link in a DR unit (definer's rights unit), then you must grant the user who will run the DR unit the `INHERIT REMOTE PRIVILEGES` privilege.

Granting the user this privilege enables the user to execute the DR unit; otherwise, the execution will fail with an `ORA-25433: User does not have INHERIT REMOTE PRIVILEGES` error. To include a connected user database link from within a definer's rights (DR) procedure, include `@database_link` in the procedure.

The following example shows how a DR unit can use a database link called `dblink` to access the `EMPLOYEE_ID` column of the `HR.EMPLOYEES` table:

Example 8-43 Database Link in a DR Unit

```
CREATE OR REPLACE PROCEDURE hr_remote_db_link
AS
v_employee_id VARCHAR(50);
BEGIN
    EXECUTE IMMEDIATE 'SELECT employee_id FROM employees@dblink' into v_employee_id;
    DBMS_OUTPUT.PUT_LINE('employee_id: ' || v_employee_id);
END ;
/
```



See Also:

Oracle Database Security Guide for more information about using the `INHERIT REMOTE PRIVILEGES` privilege, including a tutorial on how a DR unit can use a database link

8.15 External Subprograms

If a C procedure or Java method is stored in the database, you can publish it as an external subprogram and then invoke it from PL/SQL.

To publish an external subprogram, define a stored PL/SQL subprogram with a call specification. The call specification maps the name, parameter types, and return type of the external subprogram to PL/SQL equivalents. Invoke the published external subprogram by its PL/SQL name.

For example, suppose that this Java class, `Adjuster`, is stored in the database:

```
import java.sql.*;
import oracle.jdbc.driver.*;
public class Adjuster {
    public static void raiseSalary (int empNo, float percent)
    throws SQLException {
        Connection conn = new OracleDriver().defaultConnection();
        String sql = "UPDATE employees SET salary = salary * ?
            WHERE employee_id = ?";
        try {
            PreparedStatement pstmt = conn.prepareStatement(sql);
            pstmt.setFloat(1, (1 + percent / 100));
            pstmt.setInt(2, empNo);
```

```

        pstmt.executeUpdate();
        pstmt.close();
    } catch (SQLException e)
        {System.err.println(e.getMessage());}
    }
}

```

The Java class `Adjuster` has one method, `raiseSalary`, which raises the salary of a specified employee by a specified percentage. Because `raiseSalary` is a void method, you publish it as a PL/SQL procedure (rather than a function).

[Example 8-44](#) publishes the stored Java method `Adjuster.raiseSalary` as a PL/SQL standalone procedure, mapping the Java method name `Adjuster.raiseSalary` to the PL/SQL procedure name `raise_salary` and the Java data types `int` and `float` to the PL/SQL data type `NUMBER`. Then the anonymous block invokes `raise_salary`.

[Example 8-45](#) publishes the stored Java method `java.lang.Thread.sleep` as a PL/SQL standalone procedure, mapping the Java method name to the PL/SQL procedure name `java_sleep` and the Java data type `long` to the PL/SQL data type `NUMBER`. The PL/SQL standalone procedure `sleep` invokes `java_sleep`.



See Also:

Oracle Database Development Guide for more information about calling external programs

Example 8-44 PL/SQL Anonymous Block Invokes External Procedure

```

-- Publish Adjuster.raiseSalary as standalone PL/SQL procedure:

CREATE OR REPLACE PROCEDURE raise_salary (
    empid NUMBER,
    pct    NUMBER
) AS
    LANGUAGE JAVA NAME 'Adjuster.raiseSalary (int, float)'; -- call specification
/

BEGIN
    raise_salary(120, 10); -- invoke Adjuster.raiseSalary by PL/SQL name
END;
/

```

Example 8-45 PL/SQL Standalone Procedure Invokes External Procedure

```

-- Java call specification:

CREATE PROCEDURE java_sleep (
    milli_seconds IN NUMBER
) AS LANGUAGE JAVA NAME 'java.lang.Thread.sleep(long)';
/

CREATE OR REPLACE PROCEDURE sleep (
    milli_seconds IN NUMBER
) AUTHID DEFINER IS
BEGIN
    DBMS_OUTPUT.PUT_LINE(DBMS_UTILITY.get_time());
    java_sleep (milli_seconds);
END;
/

```

```
    DBMS_OUTPUT.PUT_LINE(DBMS_UTILITY.get_time());  
END;  
/
```

9

PL/SQL Triggers

A trigger is like a stored procedure that Oracle Database invokes automatically whenever a specified event occurs.



Note:

The database can detect only system-defined events. You cannot define your own events.

Topics

- [Overview of Triggers](#)
- [Reasons to Use Triggers](#)
- [DML Triggers](#)
- [Correlation Names and Pseudorecords](#)
- [System Triggers](#)
- [Subprograms Invoked by Triggers](#)
- [Trigger Compilation, Invalidation, and Recompilation](#)
- [Exception Handling in Triggers](#)
- [Trigger Design Guidelines](#)
- [Trigger Restrictions](#)
- [Order in Which Triggers Fire](#)
- [Trigger Enabling and Disabling](#)
- [Trigger Changing and Debugging](#)
- [Triggers and Oracle Database Data Transfer Utilities](#)
- [Triggers for Publishing Events](#)
- [Views for Information About Triggers](#)

9.1 Overview of Triggers

Like a stored procedure, a trigger is a named PL/SQL unit that is stored in the database and can be invoked repeatedly. Unlike a stored procedure, you can enable and disable a trigger, but you cannot explicitly invoke it.

While a trigger is **enabled**, the database automatically invokes it—that is, the trigger **fires**—whenever its triggering event occurs. While a trigger is **disabled**, it does not fire.

You create a trigger with the `CREATE TRIGGER` statement. You specify the **triggering event** in terms of **triggering statements** and the item on which they act. The trigger is said to be **created on** or **defined on** the item, which is either a table, a view, a schema, or the database. You also specify the **timing point**, which determines whether the trigger fires before or after the triggering statement runs and whether it fires for each row that the triggering statement affects. By default, a trigger is created in the enabled state.

If the trigger is created on a table or view, then the triggering event is composed of DML statements, and the trigger is called a **DML trigger**.

A **crossedition trigger** is a DML trigger for use only in edition-based redefinition.

If the trigger is created on a schema or the database, then the triggering event is composed of either DDL or database operation statements, and the trigger is called a **system trigger**.

A **conditional trigger** is a DML or system trigger that has a `WHEN` clause that specifies a SQL condition that the database evaluates for each row that the triggering statement affects.

When a trigger fires, tables that the trigger references might be undergoing changes made by SQL statements in other users' transactions. SQL statements running in triggers follow the same rules that standalone SQL statements do. Specifically:

- Queries in the trigger see the current read-consistent materialized view of referenced tables and any data changed in the same transaction.
- Updates in the trigger wait for existing data locks to be released before proceeding.

An **INSTEAD OF trigger** is either:

- A DML trigger created on either a nonconditioning view or a nested table column of a nonconditioning view
- A system trigger defined on a `CREATE` statement

The database fires the `INSTEAD OF` trigger instead of running the triggering statement.

**Note:**

A trigger is often called by the name of its triggering statement (for example, *DELETE trigger* or *LOGON trigger*), the name of the item on which it is defined (for example, *DATABASE trigger* or *SCHEMA trigger*), or its timing point (for example, *BEFORE statement trigger* or *AFTER each row trigger*).

 **See Also:**

- ["CREATE TRIGGER Statement"](#) syntax diagram
- ["DML Triggers"](#)
- ["System Triggers"](#)
- *Oracle Database Development Guide* for information about crossedition triggers
- ["CREATE TRIGGER Statement"](#) for information about the `WHEN` clause

9.2 Reasons to Use Triggers

Triggers let you customize your database management system.

For example, you can use triggers to:

- Automatically generate virtual column values
- Log events
- Gather statistics on table access
- Modify table data when DML statements are issued against views
- Enforce referential integrity when child and parent tables are on different nodes of a distributed database
- Publish information about database events, user events, and SQL statements to subscribing applications
- Prevent DML operations on a table after regular business hours
- Prevent invalid transactions
- Enforce complex business or referential integrity rules that you cannot define with constraints (see ["How Triggers and Constraints Differ"](#))

 **Caution:**

Triggers are not reliable security mechanisms, because they are programmatic and easy to disable. For high-assurance security, use Oracle Database Vault, described in *Oracle Database Vault Administrator's Guide*.

How Triggers and Constraints Differ

Both triggers and constraints can constrain data input, but they differ significantly.

A trigger always applies to new data only. For example, a trigger can prevent a DML statement from inserting a `NULL` value into a database column, but the column might contain `NULL` values that were inserted into the column before the trigger was defined or while the trigger was disabled.

A constraint can apply either to new data only (like a trigger) or to both new and existing data. Constraint behavior depends on constraint state, as explained in *Oracle Database SQL Language Reference*.

Constraints are easier to write and less error-prone than triggers that enforce the same rules. However, triggers can enforce some complex business rules that constraints cannot. Oracle strongly recommends that you use triggers to constrain data input only in these situations:

- To enforce referential integrity when child and parent tables are on different nodes of a distributed database
- To enforce complex business or referential integrity rules that you cannot define with constraints

See Also:

- *Oracle Database Development Guide* for information about using constraints to enforce business rules and prevent the entry of invalid information into tables
- "[Triggers for Ensuring Referential Integrity](#)" for information about using triggers and constraints to maintain referential integrity between parent and child tables

9.3 DML Triggers

A **DML trigger** is created on either a table or view, and its triggering event is composed of the DML statements `DELETE`, `INSERT`, and `UPDATE`.

To create a trigger that fires in response to a `MERGE` statement, create triggers on the `INSERT` and `UPDATE` statements to which the `MERGE` operation decomposes.

A DML trigger is either simple or compound.

A **simple DML trigger** fires at exactly one of these timing points:

- Before the triggering statement runs
(The trigger is called a *BEFORE statement trigger* or *statement-level BEFORE trigger*.)
- After the triggering statement runs
(The trigger is called an *AFTER statement trigger* or *statement-level AFTER trigger*.)
- Before each row that the triggering statement affects
(The trigger is called a *BEFORE each row trigger* or *row-level BEFORE trigger*.)
- After each row that the triggering statement affects
(The trigger is called an *AFTER each row trigger* or *row-level AFTER trigger*.)

A **compound DML trigger** created on a table or editioning view can fire at one, some, or all of the preceding timing points. Compound DML triggers help program an approach where you want the actions that you implement for the various timing points to share common data.

A simple or compound DML trigger that fires at row level can access the data in the row that it is processing. For details, see "[Correlation Names and Pseudorecords](#)".

An **INSTEAD OF DML trigger** is a DML trigger created on either a nonconditioning view or a nested table column of a nonconditioning view.

Except in an **INSTEAD OF** trigger, a triggering **UPDATE** statement can include a column list. With a column list, the trigger fires only when a specified column is updated. Without a column list, the trigger fires when any column of the associated table is updated.

Topics

- [Conditional Predicates for Detecting Triggering DML Statement](#)
- [INSTEAD OF DML Triggers](#)
- [Compound DML Triggers](#)
- [Triggers for Ensuring Referential Integrity](#)

9.3.1 Conditional Predicates for Detecting Triggering DML Statement

The triggering event of a DML trigger can be composed of multiple triggering statements. When one of them fires the trigger, the trigger can determine which one by using these **conditional predicates**.

Table 9-1 Conditional Predicates

Conditional Predicate	TRUE if and only if:
INSERTING	An INSERT statement fired the trigger.
UPDATING	An UPDATE statement fired the trigger.
UPDATING ('column')	An UPDATE statement that affected the specified column fired the trigger.
DELETING	A DELETE statement fired the trigger.

A conditional predicate can appear wherever a **BOOLEAN** expression can appear.

Example 9-1 Trigger Uses Conditional Predicates to Detect Triggering Statement

This example creates a DML trigger that uses conditional predicates to determine which of its four possible triggering statements fired it.

```
CREATE OR REPLACE TRIGGER t
  BEFORE
    INSERT OR
    UPDATE OF salary, department_id OR
    DELETE
  ON employees
BEGIN
  CASE
    WHEN INSERTING THEN
      DBMS_OUTPUT.PUT_LINE('Inserting');
    WHEN UPDATING('salary') THEN
      DBMS_OUTPUT.PUT_LINE('Updating salary');
    WHEN UPDATING('department_id') THEN
      DBMS_OUTPUT.PUT_LINE('Updating department ID');
    WHEN DELETING THEN
```

```

        DBMS_OUTPUT.PUT_LINE('Deleting');
    END CASE;
END;
/

```

9.3.2 INSTEAD OF DML Triggers

An **INSTEAD OF DML trigger** is a DML trigger created on a nonconditioning view, or on a nested table column of a nonconditioning view. The database fires the **INSTEAD OF trigger** instead of running the triggering DML statement.

An **INSTEAD OF trigger** cannot be conditional.

An **INSTEAD OF trigger** is the only way to update a view that is not inherently updatable. Design the **INSTEAD OF trigger** to determine what operation was intended and do the appropriate DML operations on the underlying tables.

An **INSTEAD OF trigger** is always a row-level trigger. An **INSTEAD OF trigger** can read **OLD** and **NEW** values, but cannot change them.

An **INSTEAD OF trigger** with the **NESTED TABLE** clause fires only if the triggering statement operates on the elements of the specified nested table column of the view. The trigger fires for each modified nested table element.

See Also:

- *Oracle Database SQL Language Reference* for information about inherently updatable views
- "[Compound DML Trigger Structure](#)" for information about compound DML triggers with the **INSTEAD OF EACH ROW** section

Example 9-2 INSTEAD OF Trigger

This example creates the view `oe.order_info` to display information about customers and their orders. The view is not inherently updatable (because the primary key of the `orders` table, `order_id`, is not unique in the result set of the join view). The example creates an **INSTEAD OF trigger** to process **INSERT** statements directed to the view. The trigger inserts rows into the base tables of the view, `customers` and `orders`.

```

CREATE OR REPLACE VIEW order_info AS
    SELECT c.customer_id, c.cust_last_name, c.cust_first_name,
           o.order_id, o.order_date, o.order_status
    FROM customers c, orders o
    WHERE c.customer_id = o.customer_id;

CREATE OR REPLACE TRIGGER order_info_insert
    INSTEAD OF INSERT ON order_info
    DECLARE
        duplicate_info EXCEPTION;
        PRAGMA EXCEPTION_INIT (duplicate_info, -00001);
    BEGIN
        INSERT INTO customers

```

```

        (customer_id, cust_last_name, cust_first_name)
VALUES (
    :new.customer_id,
    :new.cust_last_name,
    :new.cust_first_name);
INSERT INTO orders (order_id, order_date, customer_id)
VALUES (
    :new.order_id,
    :new.order_date,
    :new.customer_id);
EXCEPTION
    WHEN duplicate_info THEN
        RAISE_APPLICATION_ERROR (
            num=> -20107,
            msg=> 'Duplicate customer or order ID');
END order_info_insert;
/

```

Query to show that row to be inserted does not exist:

```
SELECT COUNT(*) FROM order_info WHERE customer_id = 999;
```

Result:

```

COUNT(*)
-----
          0

```

1 row selected.

Insert row into view:

```
INSERT INTO order_info VALUES
    (999, 'Smith', 'John', 2500, TO_DATE('13-MAR-2001', 'DD-MON-YYYY'), 0);
```

Result:

1 row created.

Query to show that row has been inserted in view:

```
SELECT COUNT(*) FROM order_info WHERE customer_id = 999;
```

Result:

```

COUNT(*)
-----
          1

```

1 row selected.

Query to show that row has been inserted in customers table:

```
SELECT COUNT(*) FROM customers WHERE customer_id = 999;
```

Result:

```

COUNT(*)
-----

```

```

1
1 row selected.

```

Query to show that row has been inserted in `orders` table:

```
SELECT COUNT(*) FROM orders WHERE customer_id = 999;
```

Result:

```

COUNT(*)
-----
1

```

```
1 row selected.
```

Example 9-3 INSTEAD OF Trigger on Nested Table Column of View

In this example, the view `dept_view` contains a nested table of employees, `emplist`, created by the `CAST` function (described in *Oracle Database SQL Language Reference*). To modify the `emplist` column, the example creates an `INSTEAD OF` trigger on the column.

```

-- Create type of nested table element:

CREATE OR REPLACE TYPE nte
AUTHID DEFINER IS
OBJECT (
  emp_id      NUMBER(6),
  lastname    VARCHAR2(25),
  job         VARCHAR2(10),
  sal         NUMBER(8,2)
);
/

-- Created type of nested table:

CREATE OR REPLACE TYPE emp_list_ IS
TABLE OF nte;
/

-- Create view:

CREATE OR REPLACE VIEW dept_view AS
  SELECT d.department_id,
         d.department_name,
         CAST (MULTISET (SELECT e.employee_id, e.last_name, e.job_id,
e.salary
                        FROM employees e
                        WHERE e.department_id = d.department_id
                        )
            AS emp_list_
        ) emplist
  FROM departments d;

-- Create trigger:

```

```

CREATE OR REPLACE TRIGGER dept_emplist_tr
  INSTEAD OF INSERT ON NESTED TABLE emplist OF dept_view
  REFERENCING NEW AS Employee
  PARENT AS Department
  FOR EACH ROW
BEGIN
  -- Insert on nested table translates to insert on base table:
  INSERT INTO employees (
    employee_id,
    last_name,
    email,
    hire_date,
    job_id,
    salary,
    department_id
  )
  VALUES (
    :Employee.emp_id,           -- employee_id
    :Employee.lastname,        -- last_name
    :Employee.lastname || '@example.com', -- email
    SYSDATE,                   -- hire_date
    :Employee.job,             -- job_id
    :Employee.sal,             -- salary
    :Department.department_id  -- department_id
  );
END;
/

```

Query view before inserting row into nested table:

```
SELECT emplist FROM dept_view WHERE department_id=10;
```

Result:

```

EMPLIST(EMP_ID, LASTNAME, JOB, SAL)
-----
EMP_LIST_(NTE(200, 'Whalen', 'AD_ASST', 4200))

1 row selected.

```

Query table before inserting row into nested table:

```

SELECT employee_id, last_name, job_id, salary
FROM employees
WHERE department_id = 10;

```

Result:

EMPLOYEE_ID	LAST_NAME	JOB_ID	SALARY
200	Whalen	AD_ASST	4200

1 row selected.

Insert a row into nested table:

```

INSERT INTO TABLE (
  SELECT d.emplist
  FROM dept_view d
  WHERE department_id = 10
)
VALUES (1001, 'Glenn', 'AC_MGR', 10000);

```

Query view after inserting row into nested table:

```
SELECT emplist FROM dept_view WHERE department_id=10;
```

Result (formatted to fit page):

```

EMPLIST(EMP_ID, LASTNAME, JOB, SAL)
-----
EMP_LIST_(NTE(200, 'Whalen', 'AD_ASST', 4200),
          NTE(1001, 'Glenn', 'AC_MGR', 10000))

```

1 row selected.

Query table after inserting row into nested table:

```

SELECT employee_id, last_name, job_id, salary
FROM employees
WHERE department_id = 10;

```

Result:

EMPLOYEE_ID	LAST_NAME	JOB_ID	SALARY
200	Whalen	AD_ASST	4200
1001	Glenn	AC_MGR	10000

2 rows selected.

9.3.3 Compound DML Triggers

A compound DML trigger created on a table or editing view can fire at multiple timing points. Each timing point section has its own executable part and optional exception-handling part, but all of these parts can access a common PL/SQL state. The common state is established when the triggering statement starts and is destroyed when the triggering statement completes, even when the triggering statement causes an error.

A compound DML trigger created on a nonconditioning view is not really compound, because it has only one timing point section.

A compound trigger can be conditional, but not autonomous.

Two common uses of compound triggers are:

- To accumulate rows destined for a second table so that you can periodically bulk-insert them
- To avoid the mutating-table error (ORA-04091)

Topics

- [Compound DML Trigger Structure](#)

- [Compound DML Trigger Restrictions](#)
- [Performance Benefit of Compound DML Triggers](#)
- [Using Compound DML Triggers with Bulk Insertion](#)
- [Using Compound DML Triggers to Avoid Mutating-Table Error](#)

9.3.3.1 Compound DML Trigger Structure

The optional declarative part of a compound trigger declares variables and subprograms that all of its timing-point sections can use. When the trigger fires, the declarative part runs before any timing-point sections run. The variables and subprograms exist for the duration of the triggering statement.

A compound DML trigger created on a nonconditioning view is not really compound, because it has only one timing point section. The syntax for creating the simplest compound DML trigger on a nonconditioning view is:

```
CREATE trigger FOR dml_event_clause ON view
COMPOUND TRIGGER
INSTEAD OF EACH ROW IS BEGIN
    statement;
END INSTEAD OF EACH ROW;
```

A compound DML trigger created on a table or editing view has at least one timing-point section in [Table 9-2](#). If the trigger has multiple timing-point sections, they can be in any order, but no timing-point section can be repeated. If a timing-point section is absent, then nothing happens at its timing point.

Table 9-2 Compound Trigger Timing-Point Sections

Timing Point	Section
Before the triggering statement runs	BEFORE STATEMENT
After the triggering statement runs	AFTER STATEMENT
Before each row that the triggering statement affects	BEFORE EACH ROW
After each row that the triggering statement affects	AFTER EACH ROW



See Also:

"[CREATE TRIGGER Statement](#)" for more information about the syntax of compound triggers

A compound DML trigger does not have an initialization section, but the `BEFORE STATEMENT` section, which runs before any other timing-point section, can do any necessary initialization.

If a compound DML trigger has neither a `BEFORE STATEMENT` section nor an `AFTER STATEMENT` section, and its triggering statement affects no rows, then the trigger never fires.

9.3.3.2 Compound DML Trigger Restrictions

In addition to the "[Trigger Restrictions](#)"), compound DML triggers have these restrictions:

- `OLD`, `NEW`, and `PARENT` cannot appear in the declarative part, the `BEFORE STATEMENT` section, or the `AFTER STATEMENT` section.
- Only the `BEFORE EACH ROW` section can change the value of `NEW`.
- A timing-point section cannot handle exceptions raised in another timing-point section.
- If a timing-point section includes a `GOTO` statement, the target of the `GOTO` statement must be in the same timing-point section.

9.3.3.3 Performance Benefit of Compound DML Triggers

A compound DML trigger has a performance benefit when the triggering statement affects many rows.

For example, suppose that this statement triggers a compound DML trigger that has all four timing-point sections in [Table 9-2](#):

```
INSERT INTO Target
  SELECT c1, c2, c3
  FROM Source
  WHERE Source.c1 > 0
```

Although the `BEFORE EACH ROW` and `AFTER EACH ROW` sections of the trigger run for each row of `Source` whose column `c1` is greater than zero, the `BEFORE STATEMENT` section runs only before the `INSERT` statement runs and the `AFTER STATEMENT` section runs only after the `INSERT` statement runs.

A compound DML trigger has a greater performance benefit when it uses bulk SQL, described in "[Bulk SQL and Bulk Binding](#)".

9.3.3.4 Using Compound DML Triggers with Bulk Insertion

A compound DML trigger is useful for accumulating rows destined for a second table so that you can periodically bulk-insert them. To get the performance benefit from the compound trigger, you must specify `BULK COLLECT INTO` in the `FORALL` statement (otherwise, the `FORALL` statement does a single-row DML operation multiple times). For more information about using the `BULK COLLECT` clause with the `FORALL` statement, see "[Using FORALL Statement and BULK COLLECT Clause Together](#)".



See Also:

["FORALL Statement"](#)

Scenario: You want to log every change to `hr.employees.salary` in a new table, `employee_salaries`. A single `UPDATE` statement updates many rows of the table `hr.employees`; therefore, bulk-inserting rows into `employee.salaries` is more efficient than inserting them individually.

Solution: Define a compound trigger on updates of the table `hr.employees`, as in [Example 9-4](#). You do not need a `BEFORE STATEMENT` section to initialize `idx` or `salaries`, because they are state variables, which are initialized each time the trigger fires (even when the triggering statement is interrupted and restarted).

**Note:**

To run [Example 9-4](#), you must have the EXECUTE privilege on the package DBMS_LOCK.

Example 9-4 Compound Trigger Logs Changes to One Table in Another Table

```

CREATE TABLE employee_salaries (
  employee_id NUMBER NOT NULL,
  change_date DATE NOT NULL,
  salary NUMBER(8,2) NOT NULL,
  CONSTRAINT pk_employee_salaries PRIMARY KEY (employee_id, change_date),
  CONSTRAINT fk_employee_salaries FOREIGN KEY (employee_id)
    REFERENCES employees (employee_id)
    ON DELETE CASCADE)
/
CREATE OR REPLACE TRIGGER maintain_employee_salaries
  FOR UPDATE OF salary ON employees
  COMPOUND TRIGGER

-- Declarative Part:
-- Choose small threshold value to show how example works:
threshold CONSTANT SIMPLE_INTEGER := 7;

TYPE salaries_t IS TABLE OF employee_salaries%ROWTYPE INDEX BY SIMPLE_INTEGER;
salaries salaries_t;
idx SIMPLE_INTEGER := 0;

PROCEDURE flush_array IS
  n CONSTANT SIMPLE_INTEGER := salaries.count();
BEGIN
  FORALL j IN 1..n
    INSERT INTO employee_salaries VALUES salaries(j);
  salaries.delete();
  idx := 0;
  DBMS_OUTPUT.PUT_LINE('Flushed ' || n || ' rows');
END flush_array;

-- AFTER EACH ROW Section:

AFTER EACH ROW IS
BEGIN
  idx := idx + 1;
  salaries(idx).employee_id := :NEW.employee_id;
  salaries(idx).change_date := SYSTIMESTAMP;
  salaries(idx).salary := :NEW.salary;
  IF idx >= threshold THEN
    flush_array();
  END IF;
END AFTER EACH ROW;

-- AFTER STATEMENT Section:

AFTER STATEMENT IS
BEGIN
  flush_array();
END AFTER STATEMENT;
```

```
END maintain_employee_salaries;  
/
```

Increase salary of every employee in department 50 by 10%:

```
UPDATE employees  
  SET salary = salary * 1.1  
  WHERE department_id = 50  
/
```

Result:

```
Flushed 7 rows  
Flushed 7 rows  
Flushed 7 rows  
Flushed 7 rows  
Flushed 7 rows  
Flushed 7 rows  
Flushed 3 rows
```

45 rows updated.

Wait two seconds:

```
BEGIN  
  DBMS_LOCK.SLEEP(2);  
END;  
/
```

Increase salary of every employee in department 50 by 5%:

```
UPDATE employees  
  SET salary = salary * 1.05  
  WHERE department_id = 50  
/
```

Result:

```
Flushed 7 rows  
Flushed 7 rows  
Flushed 7 rows  
Flushed 7 rows  
Flushed 7 rows  
Flushed 7 rows  
Flushed 3 rows
```

45 rows updated.

See changes to employees table reflected in employee_salaries table:

```
SELECT employee_id, count(*) c  
  FROM employee_salaries  
  GROUP BY employee_id  
/
```

Result:

EMPLOYEE_ID	C
120	2
121	2
122	2

```

          123          2
          124          2
          125          2
...
          199          2

```

45 rows selected.

9.3.3.5 Using Compound DML Triggers to Avoid Mutating-Table Error

A compound DML trigger is useful for avoiding the mutating-table error (ORA-04091) explained in "[Mutating-Table Restriction](#)".

Scenario: A business rule states that an employee's salary increase must not exceed 10% of the average salary for the employee's department. This rule must be enforced by a trigger.

Solution: Define a compound trigger on updates of the table `hr.employees`, as in [Example 9-5](#). The state variables are initialized each time the trigger fires (even when the triggering statement is interrupted and restarted).

Example 9-5 Compound Trigger Avoids Mutating-Table Error

```

CREATE OR REPLACE TRIGGER Check_Employee_Salary_Raise
  FOR UPDATE OF Salary ON Employees
COMPOUND TRIGGER
  Ten_Percent          CONSTANT NUMBER := 0.1;
  TYPE Salaries_t      IS TABLE OF Employees.Salary%TYPE;
  Avg_Salaries         Salaries_t;
  TYPE Department_IDs_t IS TABLE OF Employees.Department_ID%TYPE;
  Department_IDs      Department_IDs_t;

  -- Declare collection type and variable:

  TYPE Department_Salaries_t IS TABLE OF Employees.Salary%TYPE
    INDEX BY VARCHAR2(80);
  Department_Avg_Salaries   Department_Salaries_t;

  BEFORE STATEMENT IS
  BEGIN
    SELECT          AVG(e.Salary), NVL(e.Department_ID, -1)
      BULK COLLECT INTO Avg_Salaries, Department_IDs
    FROM            Employees e
    GROUP BY        e.Department_ID;
    FOR j IN 1..Department_IDs.COUNT() LOOP
      Department_Avg_Salaries(Department_IDs(j)) := Avg_Salaries(j);
    END LOOP;
  END BEFORE STATEMENT;

  AFTER EACH ROW IS
  BEGIN
    IF :NEW.Salary - :Old.Salary >
      Ten_Percent*Department_Avg_Salaries(:NEW.Department_ID)
    THEN
      Raise_Application_Error(-20000, 'Raise too big');
    END IF;
  END AFTER EACH ROW;
END Check_Employee_Salary_Raise;

```

9.3.4 Triggers for Ensuring Referential Integrity

You can use triggers and constraints to maintain referential integrity between parent and child tables, as [Table 9-3](#) shows. (For more information about constraints, see *Oracle Database SQL Language Reference*.)

Table 9-3 Constraints and Triggers for Ensuring Referential Integrity

Table	Constraint to Declare on Table	Triggers to Create on Table
Parent	PRIMARY KEY or UNIQUE	<p>One or more triggers that ensure that when PRIMARY KEY or UNIQUE values are updated or deleted, the desired action (RESTRICT, CASCADE, or SET NULL) occurs on corresponding FOREIGN KEY values.</p> <p>No action is required for inserts into the parent table, because no dependent foreign keys exist.</p>
Child	<p>FOREIGN KEY, if parent and child are in the same database. (The database does not support declarative referential constraints between tables on different nodes of a distributed database.)</p> <p>Disable this foreign key constraint to prevent the corresponding PRIMARY KEY or UNIQUE constraint from being dropped (except explicitly with the CASCADE option).</p>	<p>One trigger that ensures that values inserted or updated in the FOREIGN KEY correspond to PRIMARY KEY or UNIQUE values in the parent table.</p>

Topics

- [Foreign Key Trigger for Child Table](#)
- [UPDATE and DELETE RESTRICT Trigger for Parent Table](#)
- [UPDATE and DELETE SET NULL Trigger for Parent Table](#)
- [DELETE CASCADE Trigger for Parent Table](#)
- [UPDATE CASCADE Trigger for Parent Table](#)
- [Triggers for Complex Constraint Checking](#)
- [Triggers for Complex Security Authorizations](#)
- [Triggers for Transparent Event Logging](#)
- [Triggers for Deriving Column Values](#)
- [Triggers for Building Complex Updatable Views](#)
- [Triggers for Fine-Grained Access Control](#)

 **Note:**

The examples in the following topics use these tables, which share the column Deptno:

```
CREATE TABLE emp (
  Empno      NUMBER NOT NULL,
  Ename      VARCHAR2(10),
  Job        VARCHAR2(9),
  Mgr        NUMBER(4),
  Hiredate   DATE,
  Sal        NUMBER(7,2),
  Comm       NUMBER(7,2),
  Deptno     NUMBER(2) NOT NULL);
```

```
CREATE TABLE dept (
  Deptno     NUMBER(2) NOT NULL,
  Dname      VARCHAR2(14),
  Loc        VARCHAR2(13),
  Mgr_no     NUMBER,
  Dept_type  NUMBER);
```

Several triggers include statements that lock rows (`SELECT FOR UPDATE`). This operation is necessary to maintain concurrency while the rows are being processed.

These examples are not meant to be used exactly as written. They are provided to assist you in designing your own triggers.

9.3.4.1 Foreign Key Trigger for Child Table

The trigger in [Example 9-6](#) ensures that before an `INSERT` or `UPDATE` statement affects a foreign key value, the corresponding value exists in the parent key. The exception `ORA-04091` (mutating-table error) allows the trigger `emp_dept_check` to be used with the `UPDATE_SET_DEFAULT` and `UPDATE_CASCADE` triggers. This exception is unnecessary if the trigger `emp_dept_check` is used alone.

Example 9-6 Foreign Key Trigger for Child Table

```
CREATE OR REPLACE TRIGGER emp_dept_check
  BEFORE INSERT OR UPDATE OF Deptno ON emp
  FOR EACH ROW WHEN (NEW.Deptno IS NOT NULL)

  -- Before row is inserted or DEPTNO is updated in emp table,
  -- fire this trigger to verify that new foreign key value (DEPTNO)
  -- is present in dept table.
DECLARE
  Dummy                INTEGER; -- Use for cursor fetch
  Invalid_department   EXCEPTION;
  Valid_department     EXCEPTION;
  Mutating_table       EXCEPTION;
  PRAGMA EXCEPTION_INIT (Invalid_department, -4093);
  PRAGMA EXCEPTION_INIT (Valid_department, -4092);
  PRAGMA EXCEPTION_INIT (Mutating_table, -4091);
```

```

-- Cursor used to verify parent key value exists.
-- If present, lock parent key's row so it cannot be deleted
-- by another transaction until this transaction is
-- committed or rolled back.

CURSOR Dummy_cursor (Dn NUMBER) IS
  SELECT Deptno FROM dept
  WHERE Deptno = Dn
  FOR UPDATE OF Deptno;
BEGIN
  OPEN Dummy_cursor (:NEW.Deptno);
  FETCH Dummy_cursor INTO Dummy;

  -- Verify parent key.
  -- If not found, raise user-specified error code and message.
  -- If found, close cursor before allowing triggering statement to complete:

  IF Dummy_cursor%NOTFOUND THEN
    RAISE Invalid_department;
  ELSE
    RAISE Valid_department;
  END IF;
  CLOSE Dummy_cursor;
EXCEPTION
  WHEN Invalid_department THEN
    CLOSE Dummy_cursor;
    Raise_application_error(-20000, 'Invalid Department'
      || ' Number' || TO_CHAR(:NEW.deptno));
  WHEN Valid_department THEN
    CLOSE Dummy_cursor;
  WHEN Mutating_table THEN
    NULL;
END;
/

```

9.3.4.2 UPDATE and DELETE RESTRICT Trigger for Parent Table

The trigger in [Example 9-7](#) enforces the UPDATE and DELETE RESTRICT referential action on the primary key of the dept table.

Caution:

The trigger in [Example 9-7](#) does not work with self-referential tables (tables with both the primary/unique key and the foreign key). Also, this trigger does not allow triggers to cycle (such as when A fires B, which fires A).

Example 9-7 UPDATE and DELETE RESTRICT Trigger for Parent Table

```

CREATE OR REPLACE TRIGGER dept_restrict
  BEFORE DELETE OR UPDATE OF Deptno ON dept
  FOR EACH ROW

  -- Before row is deleted from dept or primary key (DEPTNO) of dept is updated,
  -- check for dependent foreign key values in emp;
  -- if any are found, roll back.

DECLARE

```

```

Dummy                INTEGER; -- Use for cursor fetch
employees_present    EXCEPTION;
employees_not_present EXCEPTION;
PRAGMA EXCEPTION_INIT (employees_present, -4094);
PRAGMA EXCEPTION_INIT (employees_not_present, -4095);

-- Cursor used to check for dependent foreign key values.
CURSOR Dummy_cursor (Dn NUMBER) IS
    SELECT Deptno FROM emp WHERE Deptno = Dn;

BEGIN
    OPEN Dummy_cursor (:OLD.Deptno);
    FETCH Dummy_cursor INTO Dummy;

    -- If dependent foreign key is found, raise user-specified
    -- error code and message. If not found, close cursor
    -- before allowing triggering statement to complete.

    IF Dummy_cursor%FOUND THEN
        RAISE employees_present;      -- Dependent rows exist
    ELSE
        RAISE employees_not_present; -- No dependent rows exist
    END IF;
    CLOSE Dummy_cursor;

EXCEPTION
    WHEN employees_present THEN
        CLOSE Dummy_cursor;
        Raise_application_error(-20001, 'Employees Present in'
            || ' Department ' || TO_CHAR(:OLD.DEPTNO));
    WHEN employees_not_present THEN
        CLOSE Dummy_cursor;
END;
```

9.3.4.3 UPDATE and DELETE SET NULL Trigger for Parent Table

The trigger in [Example 9-8](#) enforces the UPDATE and DELETE SET NULL referential action on the primary key of the dept table.

Example 9-8 UPDATE and DELETE SET NULL Trigger for Parent Table

```

CREATE OR REPLACE TRIGGER dept_set_null
    AFTER DELETE OR UPDATE OF Deptno ON dept
    FOR EACH ROW

    -- Before row is deleted from dept or primary key (DEPTNO) of dept is updated,
    -- set all corresponding dependent foreign key values in emp to NULL:

BEGIN
    IF UPDATING AND :OLD.Deptno != :NEW.Deptno OR DELETING THEN
        UPDATE emp SET emp.Deptno = NULL
            WHERE emp.Deptno = :OLD.Deptno;
    END IF;
END;
```

9.3.4.4 DELETE CASCADE Trigger for Parent Table

The trigger in [Example 9-9](#) enforces the DELETE CASCADE referential action on the primary key of the dept table.

 **Note:**

Typically, the code for DELETE CASCADE is combined with the code for UPDATE SET NULL or UPDATE SET DEFAULT, to account for both updates and deletes.

Example 9-9 DELETE CASCADE Trigger for Parent Table

```
CREATE OR REPLACE TRIGGER dept_del_cascade
  AFTER DELETE ON dept
  FOR EACH ROW

  -- Before row is deleted from dept,
  -- delete all rows from emp table whose DEPTNO is same as
  -- DEPTNO being deleted from dept table:

BEGIN
  DELETE FROM emp
  WHERE emp.Deptno = :OLD.Deptno;
END;
/
```

9.3.4.5 UPDATE CASCADE Trigger for Parent Table

The triggers in [Example 9-10](#) ensure that if a department number is updated in the dept table, then this change is propagated to dependent foreign keys in the emp table.

 **Note:**

Because the trigger dept_cascade2 updates the emp table, the emp_dept_check trigger in [Example 9-6](#), if enabled, also fires. The resulting mutating-table error is trapped by the emp_dept_check trigger. Carefully test any triggers that require error trapping to succeed to ensure that they always work properly in your environment.

Example 9-10 UPDATE CASCADE Trigger for Parent Table

```
-- Generate sequence number to be used as flag
-- for determining if update occurred on column:

CREATE SEQUENCE Update_sequence
  INCREMENT BY 1 MAXVALUE 5000 CYCLE;

CREATE OR REPLACE PACKAGE Integritypackage AUTHID DEFINER AS
  Updateseq NUMBER;
END Integritypackage;
/
CREATE OR REPLACE PACKAGE BODY Integritypackage AS
END Integritypackage;
/
-- Create flag col:

ALTER TABLE emp ADD Update_id NUMBER;
```

```

CREATE OR REPLACE TRIGGER dept_cascade1
  BEFORE UPDATE OF Deptno ON dept
DECLARE
  -- Before updating dept table (this is a statement trigger),
  -- generate sequence number
  -- & assign it to public variable UPDATESEQ of
  -- user-defined package named INTEGRITYPACKAGE:
BEGIN
  Integritypackage.Updateseq := Update_sequence.NEXTVAL;
END;
/
CREATE OR REPLACE TRIGGER dept_cascade2
  AFTER DELETE OR UPDATE OF Deptno ON dept
  FOR EACH ROW

  -- For each department number in dept that is updated,
  -- cascade update to dependent foreign keys in emp table.
  -- Cascade update only if child row was not updated by this trigger:
BEGIN
  IF UPDATING THEN
    UPDATE emp
      SET Deptno = :NEW.Deptno,
          Update_id = Integritypackage.Updateseq  --from 1st
    WHERE emp.Deptno = :OLD.Deptno
      AND Update_id IS NULL;

    /* Only NULL if not updated by 3rd trigger
       fired by same triggering statement */
  END IF;
  IF DELETING THEN
    -- After row is deleted from dept,
    -- delete all rows from emp table whose DEPTNO is same as
    -- DEPTNO being deleted from dept table:
    DELETE FROM emp
      WHERE emp.Deptno = :OLD.Deptno;
  END IF;
END;
/
CREATE OR REPLACE TRIGGER dept_cascade3
  AFTER UPDATE OF Deptno ON dept
BEGIN UPDATE emp
  SET Update_id = NULL
  WHERE Update_id = Integritypackage.Updateseq;
END;
/

```

9.3.4.6 Triggers for Complex Constraint Checking

Triggers can enforce integrity rules other than referential integrity. The trigger in [Example 9-11](#) does a complex check before allowing the triggering statement to run.

 **Note:**

[Example 9-11](#) needs this data structure:

```
CREATE TABLE Salgrade (
  Grade          NUMBER,
  Losal          NUMBER,
  Hisal          NUMBER,
  Job_classification VARCHAR2(9));
```

Example 9-11 Trigger Checks Complex Constraints

```
CREATE OR REPLACE TRIGGER salary_check
  BEFORE INSERT OR UPDATE OF Sal, Job ON Emp
  FOR EACH ROW

DECLARE
  Minsal          NUMBER;
  Maxsal          NUMBER;
  Salary_out_of_range EXCEPTION;
  PRAGMA EXCEPTION_INIT (Salary_out_of_range, -4096);

BEGIN
  /* Retrieve minimum & maximum salary for employee's new job classification
   from SALGRADE table into MINSAL and MAXSAL: */

  SELECT Losal, Hisal INTO Minsal, Maxsal
  FROM Salgrade
  WHERE Job_classification = :NEW.Job;

  /* If employee's new salary is less than or greater than
   job classification's limits, raise exception.
   Exception message is returned and pending INSERT or UPDATE statement
   that fired the trigger is rolled back: */

  IF (:NEW.Sal < Minsal OR :NEW.Sal > Maxsal) THEN
    RAISE Salary_out_of_range;
  END IF;
EXCEPTION
  WHEN Salary_out_of_range THEN
    Raise_application_error (
      -20300,
      'Salary ' || TO_CHAR(:NEW.Sal) || ' out of range for '
      || 'job classification ' || :NEW.Job
      || ' for employee ' || :NEW.Ename
    );
  WHEN NO_DATA_FOUND THEN
    Raise_application_error(-20322, 'Invalid Job Classification');
END;
/
```

9.3.4.7 Triggers for Complex Security Authorizations

Triggers are commonly used to enforce complex security authorizations for table data. Use triggers only to enforce complex security authorizations that you cannot define

using the database security features provided with the database. For example, use a trigger to prohibit updates to the `employee` table during weekends and nonworking hours.

When using a trigger to enforce a complex security authorization, it is best to use a `BEFORE` statement trigger. Using a `BEFORE` statement trigger has these benefits:

- The security check is done before the triggering statement is allowed to run, so that no wasted work is done by an unauthorized statement.
- The security check is done only for the triggering statement, not for each row affected by the triggering statement.

The trigger in [Example 9-12](#) enforces security by raising exceptions when anyone tries to update the table `employees` during weekends or nonworking hours.



See Also:

Oracle Database Security Guide for detailed information about database security features

Example 9-12 Trigger Enforces Security Authorizations

```
CREATE OR REPLACE TRIGGER Employee_permit_changes
  BEFORE INSERT OR DELETE OR UPDATE ON employees
DECLARE
  Dummy          INTEGER;
  Not_on_weekends EXCEPTION;
  Nonworking_hours EXCEPTION;
  PRAGMA EXCEPTION_INIT (Not_on_weekends, -4097);
  PRAGMA EXCEPTION_INIT (Nonworking_hours, -4099);
BEGIN
  -- Check for weekends:

  IF (TO_CHAR(Sysdate, 'DAY') = 'SAT' OR
      TO_CHAR(Sysdate, 'DAY') = 'SUN') THEN
    RAISE Not_on_weekends;
  END IF;

  -- Check for work hours (8am to 6pm):

  IF (TO_CHAR(Sysdate, 'HH24') < 8 OR
      TO_CHAR(Sysdate, 'HH24') > 18) THEN
    RAISE Nonworking_hours;
  END IF;

EXCEPTION
  WHEN Not_on_weekends THEN
    Raise_application_error(-20324, 'Might not change '
      || 'employee table during the weekend');
  WHEN Nonworking_hours THEN
    Raise_application_error(-20326, 'Might not change '
      || 'emp table during Nonworking hours');
END;
/
```

9.3.4.8 Triggers for Transparent Event Logging

Triggers are very useful when you want to transparently do a related change in the database following certain events.

The `REORDER` trigger example shows a trigger that reorders parts as necessary when certain conditions are met. (In other words, a triggering statement is entered, and the `PARTS_ON_HAND` value is less than the `REORDER_POINT` value.)

9.3.4.9 Triggers for Deriving Column Values

Triggers can derive column values automatically, based upon a value provided by an `INSERT` or `UPDATE` statement. This type of trigger is useful to force values in specific columns that depend on the values of other columns in the same row. `BEFORE` row triggers are necessary to complete this type of operation for these reasons:

- The dependent values must be derived before the `INSERT` or `UPDATE` occurs, so that the triggering statement can use the derived values.
- The trigger must fire for each row affected by the triggering `INSERT` or `UPDATE` statement.

The trigger in [Example 9-13](#) derives new column values for a table whenever a row is inserted or updated.



Note:

[Example 9-13](#) needs this change to this data structure:

```
ALTER TABLE Emp ADD(  
    Uppername VARCHAR2(20),  
    Soundexname VARCHAR2(20));
```

Example 9-13 Trigger Derives New Column Values

```
CREATE OR REPLACE TRIGGER Derived  
BEFORE INSERT OR UPDATE OF Ename ON Emp  
  
/* Before updating the ENAME field, derive the values for  
   the UPPERNAME and SOUNDEXNAME fields. Restrict users  
   from updating these fields directly: */  
FOR EACH ROW  
BEGIN  
    :NEW.Uppername := UPPER(:NEW.Ename);  
    :NEW.Soundexname := SOUNDEX(:NEW.Ename);  
END;  
/
```

9.3.4.10 Triggers for Building Complex Updatable Views

Views are an excellent mechanism to provide logical windows over table data. However, when the view query gets complex, the system implicitly cannot translate the

DML on the view into those on the underlying tables. `INSTEAD OF` triggers help solve this problem. These triggers can be defined over views, and they fire instead of the actual DML.

Consider a library system where books are arranged by title. The library consists of a collection of book type objects:

```
CREATE OR REPLACE TYPE Book_t AS OBJECT (
  Booknum    NUMBER,
  Title      VARCHAR2(20),
  Author     VARCHAR2(20),
  Available  CHAR(1)
);
/
CREATE OR REPLACE TYPE Book_list_t AS TABLE OF Book_t;
/
```

The table `Book_table` is created and populated like this:

```
DROP TABLE Book_table;
CREATE TABLE Book_table (
  Booknum    NUMBER,
  Section    VARCHAR2(20),
  Title      VARCHAR2(20),
  Author     VARCHAR2(20),
  Available  CHAR(1)
);

INSERT INTO Book_table (
  Booknum, Section, Title, Author, Available
)
VALUES (
  121001, 'Classic', 'Iliad', 'Homer', 'Y'
);

INSERT INTO Book_table (
  Booknum, Section, Title, Author, Available
)
VALUES (
  121002, 'Novel', 'Gone with the Wind', 'Mitchell M', 'N'
);

SELECT * FROM Book_table ORDER BY Booknum;
```

Result:

BOOKNUM	SECTION	TITLE	AUTHOR	A
121001	Classic	Iliad	Homer	Y
121002	Novel	Gone with the Wind	Mitchell M	N

2 rows selected.

The table `Library_table` is created and populated like this:

```
DROP TABLE Library_table;
CREATE TABLE Library_table (Section VARCHAR2(20));

INSERT INTO Library_table (Section)
VALUES ('Novel');

INSERT INTO Library_table (Section)
```

```
VALUES ('Classic');

SELECT * FROM Library_table ORDER BY Section;
```

Result:

```
SECTION
-----
Classic
Novel
```

2 rows selected.

You can define a complex view over the tables `Book_table` and `Library_table` to create a logical view of the library with sections and a collection of books in each section:

```
CREATE OR REPLACE VIEW Library_view AS
  SELECT i.Section, CAST (
    MULTISET (
      SELECT b.Booknum, b.Title, b.Author, b.Available
      FROM Book_table b
      WHERE b.Section = i.Section
    ) AS Book_list_t
  ) BOOKLIST
  FROM Library_table i;
```

(For information about the `CAST` function, see *Oracle Database SQL Language Reference*.)

Make `Library_view` updatable by defining an `INSTEAD OF` trigger on it:

```
CREATE OR REPLACE TRIGGER Library_trigger
  INSTEAD OF
  INSERT ON Library_view
  FOR EACH ROW
  DECLARE
    Bookvar Book_t;
    i        INTEGER;
  BEGIN
    INSERT INTO Library_table
    VALUES (:NEW.Section);

    FOR i IN 1..NEW.Booklist.COUNT LOOP
      Bookvar := :NEW.Booklist(i);

      INSERT INTO Book_table (
        Booknum, Section, Title, Author, Available
      )
      VALUES (
        Bookvar.booknum, :NEW.Section, Bookvar.Title,
        Bookvar.Author, bookvar.Available
      );
    END LOOP;
  END;
```

Insert a new row into `Library_view`:

```
INSERT INTO Library_view (Section, Booklist)
VALUES (
```

```
'History',
  book_list_t (book_t (121330, 'Alexander', 'Mirth', 'Y'))
);
```

See the effect on Library_view:

```
SELECT * FROM Library_view ORDER BY Section;
```

Result:

```
SECTION
-----
BOOKLIST(BOOKNUM, TITLE, AUTHOR, AVAILABLE)
-----

Classic
BOOK_LIST_T(BOOK_T(121001, 'Iliad', 'Homer', 'Y'))

History
BOOK_LIST_T(BOOK_T(121330, 'Alexander', 'Mirth', 'Y'))

Novel
BOOK_LIST_T(BOOK_T(121002, 'Gone with the Wind', 'Mitchell M', 'N'))
```

3 rows selected.

See the effect on Book_table:

```
SELECT * FROM Book_table ORDER BY Booknum;
```

Result:

BOOKNUM	SECTION	TITLE	AUTHOR	A
121001	Classic	Iliad	Homer	Y
121002	Novel	Gone with the Wind	Mitchell M	N
121330	History	Alexander	Mirth	Y

3 rows selected.

See the effect on Library_table:

```
SELECT * FROM Library_table ORDER BY Section;
```

Result:

```
SECTION
-----
Classic
History
Novel
```

3 rows selected.

Similarly, you can also define triggers on the nested table `booklist` to handle modification of the nested table element.

9.3.4.11 Triggers for Fine-Grained Access Control

You can use `LOGON` triggers to run the package associated with an application context. An application context captures session-related information about the user who is logging in to the database. From there, your application can control how much access this user has, based on his or her session information.

Note:

If you have very specific logon requirements, such as preventing users from logging in from outside the firewall or after work hours, consider using Oracle Database Vault instead of `LOGON` triggers. With Oracle Database Vault, you can create custom rules to strictly control user access.

See Also:

- *Oracle Database Security Guide* for information about creating a `LOGON` trigger to run a database session application context package
- *Oracle Database Vault Administrator's Guide* for information about Oracle Database Vault

9.4 Correlation Names and Pseudorecords

Note:

This topic applies only to triggers that fire at row level. That is:

- Row-level simple DML triggers
- Compound DML triggers with row-level timing point sections

A trigger that fires at row level can access the data in the row that it is processing by using **correlation names**. The default correlation names are `OLD`, `NEW`, and `PARENT`. To change the correlation names, use the `REFERENCING` clause of the `CREATE TRIGGER` statement (see "[referencing_clause ::=](#)").

If the trigger is created on a nested table, then `OLD` and `NEW` refer to the current row of the nested table, and `PARENT` refers to the current row of the parent table. If the trigger is created on a table or view, then `OLD` and `NEW` refer to the current row of the table or view, and `PARENT` is undefined.

`OLD`, `NEW`, and `PARENT` are also called **pseudorecords**, because they have record structure, but are allowed in fewer contexts than records are. The structure of a pseudorecord is `table_name%ROWTYPE`, where `table_name` is the name of the table on

which the trigger is created (for `OLD` and `NEW`) or the name of the parent table (for `PARENT`).

In the *trigger_body* of a simple trigger or the *tps_body* of a compound trigger, a correlation name is a placeholder for a bind variable. Reference the field of a pseudorecord with this syntax:

```
:pseudorecord_name.field_name
```

In the `WHEN` clause of a conditional trigger, a correlation name is not a placeholder for a bind variable. Therefore, omit the colon in the preceding syntax.

Table 9-4 shows the values of `OLD` and `NEW` fields for the row that the triggering statement is processing.

Table 9-4 OLD and NEW Pseudorecord Field Values

Triggering Statement	OLD.field Value	NEW.field Value
INSERT	NULL	Post-insert value
UPDATE	Pre-update value	Post-update value
DELETE	Pre-delete value	NULL

The restrictions on pseudorecords are:

- A pseudorecord cannot appear in a record-level operation.
For example, the trigger cannot include this statement:

```
:NEW := NULL;
```
- A pseudorecord cannot be an actual subprogram parameter.
(A pseudorecord field can be an actual subprogram parameter.)
- The trigger cannot change `OLD` field values.
Trying to do so raises ORA-04085.
- If the triggering statement is `DELETE`, then the trigger cannot change `NEW` field values.
Trying to do so raises ORA-04084.
- An `AFTER` trigger cannot change `NEW` field values, because the triggering statement runs before the trigger fires.
Trying to do so raises ORA-04084.

A `BEFORE` trigger can change `NEW` field values before a triggering `INSERT` or `UPDATE` statement puts them in the table.

If a statement triggers both a `BEFORE` trigger and an `AFTER` trigger, and the `BEFORE` trigger changes a `NEW` field value, then the `AFTER` trigger "sees" that change.

Example 9-14 Trigger Logs Changes to EMPLOYEES.SALARY

This example creates a log table and a trigger that inserts a row in the log table after any `UPDATE` statement affects the `SALARY` column of the `EMPLOYEES` table, and then updates `EMPLOYEES.SALARY` and shows the log table.

Create log table:

```
DROP TABLE Emp_log;
CREATE TABLE Emp_log (
  Emp_id    NUMBER,
  Log_date  DATE,
  New_salary NUMBER,
  Action    VARCHAR2(20));
```

Create trigger that inserts row in log table after EMPLOYEES.SALARY is updated:

```
CREATE OR REPLACE TRIGGER log_salary_increase
  AFTER UPDATE OF salary ON employees
  FOR EACH ROW
BEGIN
  INSERT INTO Emp_log (Emp_id, Log_date, New_salary, Action)
  VALUES (:NEW.employee_id, SYSDATE, :NEW.salary, 'New Salary');
END;
/
```

Update EMPLOYEES.SALARY:

```
UPDATE employees
SET salary = salary + 1000.0
WHERE Department_id = 20;
```

Result:

2 rows updated.

Show log table:

```
SELECT * FROM Emp_log;
```

Result:

EMP_ID	LOG_DATE	NEW_SALARY	ACTION
201	28-APR-10	13650	New Salary
202	28-APR-10	6300	New Salary

2 rows selected.

Example 9-15 Conditional Trigger Prints Salary Change Information

This example creates a conditional trigger that prints salary change information whenever a DELETE, INSERT, or UPDATE statement affects the EMPLOYEES table—unless that information is about the President. The database evaluates the WHEN condition for each affected row. If the WHEN condition is TRUE for an affected row, then the trigger fires for that row before the triggering statement runs. If the WHEN condition is not TRUE for an affected row, then trigger does not fire for that row, but the triggering statement still runs.

```
CREATE OR REPLACE TRIGGER print_salary_changes
  BEFORE DELETE OR INSERT OR UPDATE ON employees
  FOR EACH ROW
  WHEN (NEW.job_id <> 'AD_PRES') -- do not print information about President
DECLARE
  sal_diff NUMBER;
```

```

BEGIN
  sal_diff := :NEW.salary - :OLD.salary;
  DBMS_OUTPUT.PUT(:NEW.last_name || ': ');
  DBMS_OUTPUT.PUT('Old salary = ' || :OLD.salary || ', ');
  DBMS_OUTPUT.PUT('New salary = ' || :NEW.salary || ', ');
  DBMS_OUTPUT.PUT_LINE('Difference: ' || sal_diff);
END;
/

```

Query:

```

SELECT last_name, department_id, salary, job_id
FROM employees
WHERE department_id IN (10, 20, 90)
ORDER BY department_id, last_name;

```

Result:

LAST_NAME	DEPARTMENT_ID	SALARY	JOB_ID
Whalen	10	4200	AD_ASST
Fay	20	6000	MK_REP
Hartstein	20	13000	MK_MAN
De Haan	90	17000	AD_VP
King	90	24000	AD_PRES
Kochhar	90	17000	AD_VP

6 rows selected.

Triggering statement:

```

UPDATE employees
SET salary = salary * 1.05
WHERE department_id IN (10, 20, 90);

```

Result:

```

Whalen: Old salary = 4200, New salary = 4410, Difference: 210
Hartstein: Old salary = 13000, New salary = 13650, Difference: 650
Fay: Old salary = 6000, New salary = 6300, Difference: 300
Kochhar: Old salary = 17000, New salary = 17850, Difference: 850
De Haan: Old salary = 17000, New salary = 17850, Difference: 850

```

6 rows updated.

Query:

```

SELECT salary FROM employees WHERE job_id = 'AD_PRES';

```

Result:

```

      SALARY
-----
      25200

```

1 row selected.

Example 9-16 Trigger Modifies CLOB Columns

This example creates an UPDATE trigger that modifies CLOB columns.

For information about `TO_CLOB` and other conversion functions, see *Oracle Database SQL Language Reference*.

```
DROP TABLE tab1;
CREATE TABLE tab1 (c1 CLOB);
INSERT INTO tab1 VALUES ('<h1>HTML Document Fragment</h1><p>Some text.', 3);

CREATE OR REPLACE TRIGGER trg1
  BEFORE UPDATE ON tab1
  FOR EACH ROW
BEGIN
  DBMS_OUTPUT.PUT_LINE('Old value of CLOB column: '||:OLD.c1);
  DBMS_OUTPUT.PUT_LINE('Proposed new value of CLOB column: '||:NEW.c1);

  :NEW.c1 := :NEW.c1 || TO_CLOB('<hr><p>Standard footer paragraph. ');

  DBMS_OUTPUT.PUT_LINE('Final value of CLOB column: '||:NEW.c1);
END;
/

SET SERVEROUTPUT ON;
UPDATE tab1 SET c1 = '<h1>Different Document Fragment</h1><p>Different text.';

SELECT * FROM tab1;
```

Example 9-17 Trigger with REFERENCING Clause

This example creates a table with the same name as a correlation name, `new`, and then creates a trigger on that table. To avoid conflict between the table name and the correlation name, the trigger references the correlation name as `Newest`.

```
CREATE TABLE new (
  field1 NUMBER,
  field2 VARCHAR2(20)
);

CREATE OR REPLACE TRIGGER Print_salary_changes
  BEFORE UPDATE ON new
  REFERENCING new AS Newest
  FOR EACH ROW
BEGIN
  :Newest.Field2 := TO_CHAR (:newest.field1);
END;
/
```

9.4.1 OBJECT_VALUE Pseudocolumn

A DML trigger on an object table can reference the SQL pseudocolumn `OBJECT_VALUE`, which returns system-generated names for the columns of the object table. The trigger can also invoke a PL/SQL subprogram that has a formal `IN` parameter whose data type is `OBJECT_VALUE`.

 **See Also:**

- *Oracle Database SQL Language Reference* for more information about `OBJECT_VALUE`
- *Oracle Database SQL Language Reference* for general information about pseudocolumns

Example 9-18 creates object table `tbl`, table `tbl_history` for logging updates to `tbl`, and trigger `Tbl_Trg`. The trigger runs for each row of `tbl` that is affected by a DML statement, causing the old and new values of the object `t` in `tbl` to be written in `tbl_history`. The old and new values are `:OLD.OBJECT_VALUE` and `:NEW.OBJECT_VALUE`.

All values of column `n` were increased by 1. The value of `m` remains 0.

Example 9-18 Trigger References OBJECT_VALUE Pseudocolumn

Create, populate, and show object table:

```
CREATE OR REPLACE TYPE t AUTHID DEFINER AS OBJECT (n NUMBER, m NUMBER)
/
CREATE TABLE tbl OF t
/
BEGIN
  FOR j IN 1..5 LOOP
    INSERT INTO tbl VALUES (t(j, 0));
  END LOOP;
END;
/
SELECT * FROM tbl ORDER BY n;
```

Result:

N	M
1	0
2	0
3	0
4	0
5	0

5 rows selected.

Create history table and trigger:

```
CREATE TABLE tbl_history ( d DATE, old_obj t, new_obj t)
/
CREATE OR REPLACE TRIGGER Tbl_Trg
  AFTER UPDATE ON tbl
  FOR EACH ROW
BEGIN
  INSERT INTO tbl_history (d, old_obj, new_obj)
  VALUES (SYSDATE, :OLD.OBJECT_VALUE, :NEW.OBJECT_VALUE);
END Tbl_Trg;
/
```

Update object table:

```
UPDATE tbl SET tbl.n = tbl.n+1
/
```

Result:

5 rows updated.

Show old and new values:

```
BEGIN
  FOR j IN (SELECT d, old_obj, new_obj FROM tbl_history) LOOP
    DBMS_OUTPUT.PUT_LINE (
      j.d ||
      ' -- old: ' || j.old_obj.n || ' ' || j.old_obj.m ||
      ' -- new: ' || j.new_obj.n || ' ' || j.new_obj.m
    );
  END LOOP;
END;
/
```

Result:

```
28-APR-10 -- old: 1 0 -- new: 2 0
28-APR-10 -- old: 2 0 -- new: 3 0
28-APR-10 -- old: 3 0 -- new: 4 0
28-APR-10 -- old: 4 0 -- new: 5 0
28-APR-10 -- old: 5 0 -- new: 6 0
```

9.5 System Triggers

A **system trigger** is created on either a schema or the database.

Its triggering event is composed of either DDL statements (listed in "*ddl_event*") or database operation statements (listed in "*database_event*").

A system trigger fires at exactly one of these timing points:

- Before the triggering statement runs
(The trigger is called a *BEFORE statement trigger* or *statement-level BEFORE trigger*.)
- After the triggering statement runs
(The trigger is called a *AFTER statement trigger* or *statement-level AFTER trigger*.)
- Instead of the triggering CREATE statement
(The trigger is called an *INSTEAD OF CREATE trigger*.)

Topics

- [SCHEMA Triggers](#)
- [DATABASE Triggers](#)
- [INSTEAD OF CREATE Triggers](#)

9.5.1 SCHEMA Triggers

A **SCHEMA trigger** is created on a schema and fires whenever the user who owns it is the current user and initiates the triggering event.

Suppose that both user1 and user2 own schema triggers, and user1 invokes a DR unit owned by user2. Inside the DR unit, user2 is the current user. Therefore, if the DR unit initiates the triggering event of a schema trigger that user2 owns, then that trigger fires. However, if the DR unit initiates the triggering event of a schema trigger that user1 owns, then that trigger does not fire.

Example 9-19 creates a `BEFORE` statement trigger on the sample schema `HR`. When a user connected as `HR` tries to drop a database object, the database fires the trigger before dropping the object.

Example 9-19 BEFORE Statement Trigger on Sample Schema HR

```
CREATE OR REPLACE TRIGGER drop_trigger
  BEFORE DROP ON hr.SCHEMA
  BEGIN
    RAISE_APPLICATION_ERROR (
      num => -20000,
      msg => 'Cannot drop object');
  END;
/
```

9.5.2 DATABASE Triggers

A **DATABASE trigger** is created on the database and fires whenever any database user initiates the triggering event.

Example 9-20 shows the basic syntax for a trigger to log errors. This trigger fires after an unsuccessful statement execution, such as unsuccessful logon.

Note:

An `AFTER SERVERERROR` trigger fires only if Oracle relational database management system (RDBMS) determines that it is safe to fire error triggers. For more information about `AFTER SERVERERROR` triggers, see [CREATE TRIGGER Statement](#).

The trigger in **Example 9-21** runs the procedure `check_user` after a user logs onto the database.

Example 9-20 AFTER Statement Trigger on Database

```
CREATE TRIGGER log_errors
  AFTER SERVERERROR ON DATABASE
  BEGIN
    IF (IS_SERVERERROR (1017)) THEN
      NULL; -- (substitute code that processes logon error)
    ELSE
      NULL; -- (substitute code that logs error code)
    END IF;
  END;
/
```

Example 9-21 Trigger Monitors Logons

```
CREATE OR REPLACE TRIGGER check_user
  AFTER LOGON ON DATABASE
  BEGIN
```



```

        check_user;
    EXCEPTION
    WHEN OTHERS THEN
        RAISE_APPLICATION_ERROR
            (-20000, 'Unexpected error: '|| DBMS_UTILITY.Format_Error_Stack);
    END;
/

```

9.5.3 INSTEAD OF CREATE Triggers

An **INSTEAD OF CREATE** trigger is a **SCHEMA** trigger whose triggering event is a **CREATE** statement. The database fires the trigger instead of executing its triggering statement.

[Example 9-22](#) shows the basic syntax for an **INSTEAD OF CREATE** trigger on the current schema. This trigger fires when the owner of the current schema issues a **CREATE** statement in the current schema.

Example 9-22 INSTEAD OF CREATE Trigger on Schema

```

CREATE OR REPLACE TRIGGER t
    INSTEAD OF CREATE ON SCHEMA
    BEGIN
        EXECUTE IMMEDIATE 'CREATE TABLE T (n NUMBER, m NUMBER)';
    END;
/

```

9.6 Subprograms Invoked by Triggers

Triggers can invoke subprograms written in PL/SQL, C, and Java. The trigger in [Example 9-4](#) invokes a PL/SQL subprogram. The trigger in [Example 9-23](#) invokes a Java subprogram.

A subprogram invoked by a trigger cannot run transaction control statements, because the subprogram runs in the context of the trigger body.

If a trigger invokes an invoker rights (IR) subprogram, then the user who created the trigger, not the user who ran the triggering statement, is considered to be the current user. For information about IR subprograms, see "[Invoker's Rights and Definer's Rights \(AUTHID Property\)](#)".

If a trigger invokes a remote subprogram, and a time stamp or signature mismatch is found during execution of the trigger, then the remote subprogram does not run and the trigger is invalidated.

Example 9-23 Trigger Invokes Java Subprogram

```

CREATE OR REPLACE PROCEDURE Before_delete (Id IN NUMBER, Ename VARCHAR2)
    IS LANGUAGE Java
    name 'thjvTriggers.beforeDelete (oracle.jdbc.NUMBER, oracle.jdbc.CHAR)';

CREATE OR REPLACE TRIGGER Pre_del_trigger BEFORE DELETE ON Tab
    FOR EACH ROW
    CALL Before_delete (:OLD.Id, :OLD.Ename)
/

```

The corresponding Java file is thjvTriggers.java:

```

import java.sql.*
import java.io.*

```

```
import oracle.jdbc.*
import oracle.oracore.*
public class thjvTriggers
{
public static void
beforeDelete (NUMBER old_id, CHAR old_name)
throws SQLException, CoreException
{
    Connection conn = JDBCConnection.defaultConnection();
    Statement stmt = conn.createStatement();
    String sql = "insert into logtab values
("+ old_id.intValue() +", '"+ old_ename.toString() + ", BEFORE DELETE)";
    stmt.executeUpdate (sql);
    stmt.close();
    return;
}
}
```

9.7 Trigger Compilation, Invalidation, and Recompilation

The `CREATE TRIGGER` statement compiles the trigger and stores its code in the database. If a compilation error occurs, the trigger is still created, but its triggering statement fails, except in these cases:

- The trigger was created in the disabled state.
- The triggering event is `AFTER STARTUP ON DATABASE`.
- The triggering event is either `AFTER LOGON ON DATABASE` or `AFTER LOGON ON SCHEMA`, and someone logs on as `SYSTEM`.

To see trigger compilation errors, either use the `SHOW ERRORS` command in `SQL*Plus` or Enterprise Manager, or query the static data dictionary view `*_ERRORS` (described in *Oracle Database Reference*).

If a trigger does not compile successfully, then its exception handler cannot run. For an example, see "[Remote Exception Handling](#)".

If a trigger references another object, such as a subprogram or package, and that object is modified or dropped, then the trigger becomes invalid. The next time the triggering event occurs, the compiler tries to revalidate the trigger (for details, see *Oracle Database Development Guide*).



Note:

Because the `DBMS_AQ` package is used to enqueue a message, dependency between triggers and queues cannot be maintained.

To recompile a trigger manually, use the `ALTER TRIGGER` statement, described in "[ALTER TRIGGER Statement](#)".

9.8 Exception Handling in Triggers

In most cases, if a trigger runs a statement that raises an exception, and the exception is not handled by an exception handler, then the database rolls back the effects of both the trigger and its triggering statement.

In the following cases, the database rolls back only the effects of the trigger, not the effects of the triggering statement (and logs the error in trace files and the alert log):

- The triggering event is either `AFTER STARTUP ON DATABASE` or `BEFORE SHUTDOWN ON DATABASE`.
- The triggering event is `AFTER LOGON ON DATABASE` and the user has the `ADMINISTER DATABASE TRIGGER` privilege.
- The triggering event is `AFTER LOGON ON SCHEMA` and the user either owns the schema or has the `ALTER ANY TRIGGER` privilege.

In the case of a compound DML trigger, the database rolls back only the effects of the triggering statement, not the effects of the trigger. However, variables declared in the trigger are re-initialized, and any values computed before the triggering statement was rolled back are lost.



Note:

Triggers that enforce complex security authorizations or constraints typically raise user-defined exceptions, which are explained in "[User-Defined Exceptions](#)".



See Also:

[PL/SQL Error Handling](#), for general information about exception handling

Remote Exception Handling

A trigger that accesses a remote database can do remote exception handling only if the remote database is available. If the remote database is unavailable when the local database must compile the trigger, then the local database cannot validate the statement that accesses the remote database, and the compilation fails. If the trigger cannot be compiled, then its exception handler cannot run.

The trigger in [Example 9-24](#) has an `INSERT` statement that accesses a remote database. The trigger also has an exception handler. However, if the remote database is unavailable when the local database tries to compile the trigger, then the compilation fails and the exception handler cannot run.

[Example 9-25](#) shows the workaround for the problem in [Example 9-24](#): Put the remote `INSERT` statement and exception handler in a stored subprogram and have the trigger invoke the stored subprogram. The subprogram is stored in the local database in compiled form, with a validated statement for accessing the remote database.

Therefore, when the remote `INSERT` statement fails because the remote database is unavailable, the exception handler in the subprogram can handle it.

Example 9-24 Trigger Cannot Handle Exception if Remote Database is Unavailable

```
CREATE OR REPLACE TRIGGER employees_tr
  AFTER INSERT ON employees
  FOR EACH ROW
BEGIN
  -- When remote database is unavailable, compilation fails here:
  INSERT INTO employees@remote (
    employee_id, first_name, last_name, email, hire_date, job_id
  )
  VALUES (
    99, 'Jane', 'Doe', 'jane.doe@example.com', SYSDATE, 'ST_MAN'
  );
EXCEPTION
  WHEN OTHERS THEN
    INSERT INTO emp_log (Emp_id, Log_date, New_salary, Action)
      VALUES (99, SYSDATE, NULL, 'Could not insert');
    RAISE;
END;
/
```

Example 9-25 Workaround for Example 9-24

```
CREATE OR REPLACE PROCEDURE insert_row_proc AUTHID CURRENT_USER AS
  no_remote_db EXCEPTION; -- declare exception
  PRAGMA EXCEPTION_INIT (no_remote_db, -20000);
  -- assign error code to exception
BEGIN
  INSERT INTO employees@remote (
    employee_id, first_name, last_name, email, hire_date, job_id
  )
  VALUES (
    99, 'Jane', 'Doe', 'jane.doe@example.com', SYSDATE, 'ST_MAN'
  );
EXCEPTION
  WHEN OTHERS THEN
    INSERT INTO emp_log (Emp_id, Log_date, New_salary, Action)
      VALUES (99, SYSDATE, NULL, 'Could not insert row.');
```

```
    RAISE_APPLICATION_ERROR (-20000, 'Remote database is unavailable.');
```

```
END;
/
```

```
CREATE OR REPLACE TRIGGER employees_tr
  AFTER INSERT ON employees
  FOR EACH ROW
BEGIN
  insert_row_proc;
END;
/
```

9.9 Trigger Design Guidelines

- Use triggers to ensure that whenever a specific event occurs, any necessary actions are done (regardless of which user or application issues the triggering statement).

For example, use a trigger to ensure that whenever anyone updates a table, its log file is updated.

- Do not create triggers that duplicate database features.

For example, do not create a trigger to reject invalid data if you can do the same with constraints (see "[How Triggers and Constraints Differ](#)").

- Do not create triggers that depend on the order in which a SQL statement processes rows (which can vary).

For example, do not assign a value to a global package variable in a row trigger if the current value of the variable depends on the row being processed by the row trigger. If a trigger updates global package variables, initialize those variables in a `BEFORE` statement trigger.

- Use `BEFORE` row triggers to modify the row before writing the row data to disk.
- Use `AFTER` row triggers to obtain the row ID and use it in operations.

An `AFTER` row trigger fires when the triggering statement results in ORA-02292.

 **Note:**

`AFTER` row triggers are slightly more efficient than `BEFORE` row triggers. With `BEFORE` row triggers, affected data blocks are read first for the trigger and then for the triggering statement. With `AFTER` row triggers, affected data blocks are read only for the trigger.

- If the triggering statement of a `BEFORE` statement trigger is an `UPDATE` or `DELETE` statement that conflicts with an `UPDATE` statement that is running, then the database does a transparent `ROLLBACK TO SAVEPOINT` and restarts the triggering statement. The database can do this many times before the triggering statement completes successfully. Each time the database restarts the triggering statement, the trigger fires. The `ROLLBACK TO SAVEPOINT` does not undo changes to package variables that the trigger references. To detect this situation, include a counter variable in the package.

- Do not create recursive triggers.

For example, do not create an `AFTER UPDATE` trigger that issues an `UPDATE` statement on the table on which the trigger is defined. The trigger fires recursively until it runs out of memory.

- If you create a trigger that includes a statement that accesses a remote database, then put the exception handler for that statement in a stored subprogram and invoke the subprogram from the trigger.

For more information, see "[Remote Exception Handling](#)".

- Use `DATABASE` triggers judiciously. They fire every time any database user initiates a triggering event.
- If a trigger runs the following statement, the statement returns the owner of the trigger, not the user who is updating the table:

```
SELECT Username FROM USER_USERS;
```

- Only committed triggers fire.

A trigger is committed, implicitly, after the `CREATE TRIGGER` statement that creates it succeeds. Therefore, the following statement cannot fire the trigger that it creates:

```
CREATE OR REPLACE TRIGGER my_trigger
  AFTER CREATE ON DATABASE
BEGIN
  NULL;
END;
/
```

- To allow the modular installation of applications that have triggers on the same tables, create multiple triggers of the same type, rather than a single trigger that runs a sequence of operations.

Each trigger sees the changes made by the previously fired triggers. Each trigger can see `OLD` and `NEW` values.

9.10 Trigger Restrictions

In addition to the restrictions that apply to all PL/SQL units (see [Table C-1](#)), triggers have these restrictions:

- [Trigger Size Restriction](#)
- [Trigger LONG and LONG RAW Data Type Restrictions](#)
- [Mutating-Table Restriction](#)
- Only an autonomous trigger can run TCL or DDL statements.
For information about autonomous triggers, see "[Autonomous Triggers](#)".
- A trigger cannot invoke a subprogram that runs transaction control statements, because the subprogram runs in the context of the trigger body.
For more information about subprograms invoked by triggers, see "[Subprograms Invoked by Triggers](#)".
- A trigger cannot access a `SERIALLY_REUSABLE` package.
For information about `SERIALLY_REUSABLE` packages, see "[SERIALLY_REUSABLE Packages](#)".



See Also:

["Compound DML Trigger Restrictions"](#)

9.10.1 Trigger Size Restriction

The size of the trigger cannot exceed 32K.

If the logic for your trigger requires much more than 60 lines of PL/SQL source text, then put most of the source text in a stored subprogram and invoke the subprogram from the trigger. For information about subprograms invoked by triggers, see "[Subprograms Invoked by Triggers](#)".

9.10.2 Trigger LONG and LONG RAW Data Type Restrictions



Note:

Oracle supports the `LONG` and `LONG RAW` data types only for backward compatibility with existing applications.

In addition to the restrictions that apply to all PL/SQL units (see "[LONG and LONG RAW Variables](#)"), triggers have these restrictions:

- A trigger cannot declare a variable of the `LONG` or `LONG RAW` data type.
- A SQL statement in a trigger can reference a `LONG` or `LONG RAW` column only if the column data can be converted to the data type `CHAR` or `VARCHAR2`.
- A trigger cannot use the correlation name `NEW` or `PARENT` with a `LONG` or `LONG RAW` column.

9.10.3 Mutating-Table Restriction



Note:

This topic applies only to row-level simple DML triggers.

A **mutating table** is a table that is being modified by a DML statement (possibly by the effects of a `DELETE CASCADE` constraint). (A view being modified by an `INSTEAD OF` trigger is not considered to be mutating.)

The mutating-table restriction prevents the trigger from querying or modifying the table that the triggering statement is modifying. When a row-level trigger encounters a mutating table, ORA-04091 occurs, the effects of the trigger and triggering statement are rolled back, and control returns to the user or application that issued the triggering statement, as [Example 9-26](#) shows.



Caution:

Oracle Database does not enforce the mutating-table restriction for a trigger that accesses remote nodes, because the database does not support declarative referential constraints between tables on different nodes of a distributed database.

Similarly, the database does not enforce the mutating-table restriction for tables in the same database that are connected by loop-back database links. A loop-back database link makes a local table appear remote by defining an Oracle Net path back to the database that contains the link.

If you must use a trigger to update a mutating table, you can avoid the mutating-table error in either of these ways:

- Use a compound DML trigger (see "[Using Compound DML Triggers to Avoid Mutating-Table Error](#)").
- Use a temporary table.

For example, instead of using one `AFTER` each row trigger that updates the mutating table, use two triggers—an `AFTER` each row trigger that updates the temporary table and an `AFTER` statement trigger that updates the mutating table with the values from the temporary table.

Mutating-Table Restriction Relaxed

As of Oracle Database 8g Release 1, a deletion from the parent table causes `BEFORE` and `AFTER` triggers to fire once. Therefore, you can create row-level and statement-level triggers that query and modify the parent and child tables. This allows most foreign key constraint actions to be implemented through their after-row triggers (unless the constraint is self-referential). Update cascade, update set null, update set default, delete set default, inserting a missing parent, and maintaining a count of children can all be implemented easily—see "[Triggers for Ensuring Referential Integrity](#)".

However, cascades require care for multiple-row foreign key updates. The trigger cannot miss rows that were changed but not committed by another transaction, because the foreign key constraint guarantees that no matching foreign key rows are locked before the after-row trigger is invoked.

In [Example 9-27](#), the triggering statement updates `p` correctly but causes problems when the trigger updates `f`. First, the triggering statement changes (1) to (2) in `p`, and the trigger updates (1) to (2) in `f`, leaving two rows of value (2) in `f`. Next, the triggering statement updates (2) to (3) in `p`, and the trigger updates both rows of value (2) to (3) in `f`. Finally, the statement updates (3) to (4) in `p`, and the trigger updates all three rows in `f` from (3) to (4). The relationship between the data items in `p` and `f` is lost.

To avoid this problem, either forbid multiple-row updates to `p` that change the primary key and reuse existing primary key values, or track updates to foreign key values and modify the trigger to ensure that no row is updated twice.

Example 9-26 Trigger Causes Mutating-Table Error

```
-- Create log table

DROP TABLE log;
CREATE TABLE log (
  emp_id NUMBER(6),
  l_name VARCHAR2(25),
  f_name VARCHAR2(20)
);

-- Create trigger that updates log and then reads employees

CREATE OR REPLACE TRIGGER log_deletions
  AFTER DELETE ON employees
  FOR EACH ROW
DECLARE
  n INTEGER;
BEGIN
  INSERT INTO log VALUES (
    :OLD.employee_id,
```



```

        :OLD.last_name,
        :OLD.first_name
    );

    SELECT COUNT(*) INTO n FROM employees;
    DBMS_OUTPUT.PUT_LINE('There are now ' || n || ' employees.');
```

END;

/

-- Issue triggering statement:

DELETE FROM employees WHERE employee_id = 197;

Result:

```

DELETE FROM employees WHERE employee_id = 197
      *
ERROR at line 1:
ORA-04091: table HR.EMPLOYEES is mutating, trigger/function might not see it
ORA-06512: at "HR.LOG_DELETIONS", line 10
ORA-04088: error during execution of trigger 'HR.LOG_DELETIONS'
```

Show that effect of trigger was rolled back:

```
SELECT count(*) FROM log;
```

Result:

```

COUNT(*)
-----
          0

1 row selected.
```

Show that effect of triggering statement was rolled back:

```
SELECT employee_id, last_name FROM employees WHERE employee_id = 197;
```

Result:

```

EMPLOYEE_ID LAST_NAME
-----
          197 Feeney

1 row selected.
```

Example 9-27 Update Cascade

```

DROP TABLE p;
CREATE TABLE p (p1 NUMBER CONSTRAINT pk_p_p1 PRIMARY KEY);
INSERT INTO p VALUES (1);
INSERT INTO p VALUES (2);
INSERT INTO p VALUES (3);

DROP TABLE f;
CREATE TABLE f (f1 NUMBER CONSTRAINT fk_f_f1 REFERENCES p);
INSERT INTO f VALUES (1);
INSERT INTO f VALUES (2);
INSERT INTO f VALUES (3);

CREATE TRIGGER pt
  AFTER UPDATE ON p
```

```

FOR EACH ROW
BEGIN
  UPDATE f SET f1 = :NEW.p1 WHERE f1 = :OLD.p1;
END;
/

```

Query:

```
SELECT * FROM p ORDER BY p1;
```

Result:

```

          P1
-----
          1
          2
          3

```

Query:

```
SELECT * FROM f ORDER BY f1;
```

Result:

```

          F1
-----
          1
          2
          3

```

Issue triggering statement:

```
UPDATE p SET p1 = p1+1;
```

Query:

```
SELECT * FROM p ORDER BY p1;
```

Result:

```

          P1
-----
          2
          3
          4

```

Query:

```
SELECT * FROM f ORDER BY f1;
```

Result:

```

          F1
-----
          4
          4
          4

```

9.11 Order in Which Triggers Fire

If two or more triggers *with different timing points* are defined for the same statement on the same table, then they fire in this order:

1. All `BEFORE STATEMENT` triggers
2. All `BEFORE EACH ROW` triggers
3. All `AFTER EACH ROW` triggers
4. All `AFTER STATEMENT` triggers

If it is practical, replace the set of individual triggers with different timing points with a single compound trigger that explicitly codes the actions in the order you intend. For information about compound triggers, see "[Compound DML Triggers](#)".

If you are creating two or more triggers *with the same timing point*, and the order in which they fire is important, then you can control their firing order using the `FOLLOWS` and `PRECEDES` clauses (see "[FOLLOWS | PRECEDES](#)").

If multiple compound triggers are created on a table, then:

- All `BEFORE STATEMENT` sections run at the `BEFORE STATEMENT` timing point, `BEFORE EACH ROW` sections run at the `BEFORE EACH ROW` timing point, and so forth.

If trigger execution order was specified using the `FOLLOWS` clause, then the `FOLLOWS` clause determines the order of execution of compound trigger sections. If `FOLLOWS` is specified for some but not all triggers, then the order of execution of triggers is guaranteed only for those that are related using the `FOLLOWS` clause.

- All `AFTER STATEMENT` sections run at the `AFTER STATEMENT` timing point, `AFTER EACH ROW` sections run at the `AFTER EACH ROW` timing point, and so forth.

If trigger execution order was specified using the `PRECEDES` clause, then the `PRECEDES` clause determines the order of execution of compound trigger sections. If `PRECEDES` is specified for some but not all triggers, then the order of execution of triggers is guaranteed only for those that are related using the `PRECEDES` clause.

 **Note:**

`PRECEDES` applies only to reverse crossedition triggers, which are described in *Oracle Database Development Guide*.

The firing of compound triggers can be interleaved with the firing of simple triggers.

When one trigger causes another trigger to fire, the triggers are said to be **cascading**. The database allows up to 32 triggers to cascade simultaneously. To limit the number of trigger cascades, use the initialization parameter `OPEN_CURSORS` (described in *Oracle Database Reference*), because a cursor opens every time a trigger fires.

9.12 Trigger Enabling and Disabling

By default, the `CREATE TRIGGER` statement creates a trigger in the enabled state. To create a trigger in the disabled state, specify `DISABLE`. Creating a trigger in the disabled state lets you ensure that it compiles without errors before you enable it.

Some reasons to temporarily disable a trigger are:

- The trigger refers to an unavailable object.
- You must do a large data load, and you want it to proceed quickly without firing triggers.
- You are reloading data.

To enable or disable a single trigger, use this statement:

```
ALTER TRIGGER [schema.]trigger_name { ENABLE | DISABLE };
```

To enable or disable all triggers in all editions created on a specific table, use this statement:

```
ALTER TABLE table_name { ENABLE | DISABLE } ALL TRIGGERS;
```

In both of the preceding statements, `schema` is the name of the schema containing the trigger, and the default is your schema.

See Also:

- "[ALTER TRIGGER Statement](#)" for more information about the `ALTER TRIGGER` statement
- *Oracle Database SQL Language Reference* for more information about the `ALTER TABLE` statement

9.13 Trigger Changing and Debugging

To change a trigger, you must either replace or re-create it. (The `ALTER TRIGGER` statement only enables, disables, compiles, or renames a trigger.)

To replace a trigger, use the `CREATE TRIGGER` statement with the `OR REPLACE` clause.

To re-create a trigger, first drop it with the `DROP TRIGGER` statement and then create it again with the `CREATE TRIGGER` statement.

To debug a trigger, you can use the facilities available for stored subprograms. For information about these facilities, see *Oracle Database Development Guide*.

 **See Also:**

- "[CREATE TRIGGER Statement](#)" for more information about the `CREATE TRIGGER` statement
- "[DROP TRIGGER Statement](#)" for more information about the `DROP TRIGGER` statement
- "[ALTER TRIGGER Statement](#)" for more information about the `ALTER TRIGGER` statement

9.14 Triggers and Oracle Database Data Transfer Utilities

The Oracle database utilities that transfer data to your database, possibly firing triggers, are:

- **SQL*Loader (`sqlldr`)**

SQL*Loader loads data from external files into tables of an Oracle database.

During a SQL*Loader conventional load, `INSERT` triggers fire.

Before a SQL*Loader direct load, triggers are disabled.

 **See Also:**

Oracle Database Utilities for more information about SQL*Loader

- **Data Pump Import (`impdp`)**

Data Pump Import (`impdp`) reads an export dump file set created by Data Pump Export (`expdp`) and writes it to an Oracle database.

If a table to be imported does not exist on the target database, or if you specify `TABLE_EXISTS_ACTION=REPLACE`, then `impdp` creates and loads the table before creating any triggers, so no triggers fire.

If a table to be imported exists on the target database, and you specify either `TABLE_EXISTS_ACTION=APPEND` or `TABLE_EXISTS_ACTION=TRUNCATE`, then `impdp` loads rows into the existing table, and `INSERT` triggers created on the table fire.

 **See Also:**

Oracle Database Utilities for more information about Data Pump Import

- **Original Import (`imp`)**

Original Import (the original Import utility, `imp`) reads object definitions and table data from dump files created by original Export (the original Export utility, `exp`) and writes them to the target database.

 **Note:**

To import files that original Export created, you must use original Import. In all other cases, Oracle recommends that you use Data Pump Import instead of original Import.

If a table to be imported does not exist on the target database, then `imp` creates and loads the table before creating any triggers, so no triggers fire.

If a table to be imported exists on the target database, then the Import `IGNORE` parameter determines whether triggers fire during import operations. The `IGNORE` parameter specifies whether object creation errors are ignored or not, resulting in the following behavior:

- If `IGNORE=n` (default), then `imp` does not change the table and no triggers fire.
- If `IGNORE=y`, then `imp` loads rows into the existing table, and `INSERT` triggers created on the table fire.

 **See Also:**

- *Oracle Database Utilities* for more information about the original Import utility
- *Oracle Database Utilities* for more information about the original Export utility
- *Oracle Database Utilities* for more information about `IGNORE`

9.15 Triggers for Publishing Events

To use a trigger to publish an event, create a trigger that:

- Has the event as its triggering event
- Invokes the appropriate subprograms in the `DBMS_AQ` package, which provides an interface to Oracle Advanced Queuing (AQ)

For information about the `DBMS_AQ` package, see *Oracle Database PL/SQL Packages and Types Reference*.

For information about AQ, see *Oracle Database Advanced Queuing User's Guide*.

By enabling and disabling such triggers, you can turn event notification on and off. For information about enabling and disabling triggers, see "[Trigger Enabling and Disabling](#)".

How Triggers Publish Events

When the database detects an event, it fires all enabled triggers that are defined on that event, except:

- Any trigger that is the target of the triggering event.

For example, a trigger for all `DROP` events does not fire when it is dropped itself.

- Any trigger that was modified, but not committed, in the same transaction as the triggering event.

For example, if a recursive DDL statement in a system trigger modifies another trigger, then events in the same transaction cannot fire the modified trigger.

When a trigger fires and invokes AQ, AQ publishes the event and passes to the trigger the publication context and specified attributes. The trigger can access the attributes by invoking event attribute functions.

The attributes that a trigger can specify to AQ (by passing them to AQ as `IN` parameters) and then access with event attribute functions depends on the triggering event, which is either a database event or a client event.

Note:

- A trigger always behaves like a definer rights (DR) unit. The trigger action of an event runs as the definer of the action (as the definer of the package or function in callouts, or as owner of the trigger in queues). Because the owner of the trigger must have `EXECUTE` privileges on the underlying queues, packages, or subprograms, this action is consistent. For information about DR units, see "[Invoker's Rights and Definer's Rights \(AUTHID Property\)](#)".
- The database ignores the return status from callback functions for all events. For example, the database does nothing with the return status from a `SHUTDOWN` event.

Topics

- [Event Attribute Functions](#)
- [Event Attribute Functions for Database Event Triggers](#)
- [Event Attribute Functions for Client Event Triggers](#)

9.15.1 Event Attribute Functions

By invoking system-defined event attribute functions in [Table 9-5](#), a trigger can retrieve certain attributes of the triggering event. Not all triggers can invoke all event attribute functions—for details, see "[Event Attribute Functions for Database Event Triggers](#)" and "[Event Attribute Functions for Client Event Triggers](#)".

Note:

- In earlier releases, you had to access these functions through the `SYS` package. Now Oracle recommends accessing them with their public synonyms (the names starting with `ora_` in the first column of [Table 9-5](#)).

- The function parameter `ora_name_list_t` is defined in package `DBMS_STANDARD` as:

```
TYPE ora_name_list_t IS TABLE OF VARCHAR2(2*(ORA_MAX_NAME_LEN+2)+1);
```

Table 9-5 System-Defined Event Attributes

Attribute	Return Type and Value	Example
<code>ora_client_ip_address</code>	VARCHAR2: IP address of client in LOGON event when underlying protocol is TCP/IP	<pre> DECLARE v_addr VARCHAR2(11); BEGIN IF (ora_sysevent = 'LOGON') THEN v_addr := ora_client_ip_address; END IF; END; / </pre>
<code>ora_database_name</code>	VARCHAR2(50): Database name	<pre> DECLARE v_db_name VARCHAR2(50); BEGIN v_db_name := ora_database_name; END; / </pre>
<code>ora_des_encrypted_password</code>	VARCHAR2: DES-encrypted password of user being created or altered	<pre> IF (ora_dict_obj_type = 'USER') THEN INSERT INTO event_table VALUES (ora_des_encrypted_password); END IF; </pre>
<code>ora_dict_obj_name</code>	VARCHAR2(128): Name of dictionary object on which DDL operation occurred	<pre> INSERT INTO event_table VALUES ('Changed object is ' ora_dict_obj_name); </pre>
<code>ora_dict_obj_name_list (name_list OUT ora_name_list_t)</code>	PLS_INTEGER: Number of object names modified in event OUT parameter: List of object names modified in event	<pre> DECLARE name_list ora_name_list_t; number_modified PLS_INTEGER; BEGIN IF (ora_sysevent='ASSOCIATE STATISTICS') THEN number_modified := ora_dict_obj_name_list(name_list); END IF; END; </pre>
<code>ora_dict_obj_owner</code>	VARCHAR2(128): Owner of dictionary object on which DDL operation occurred	<pre> INSERT INTO event_table VALUES ('object owner is' ora_dict_obj_owner); </pre>

Table 9-5 (Cont.) System-Defined Event Attributes

Attribute	Return Type and Value	Example
<pre>ora_dict_obj_owner_list (owner_list OUT ora_name_list_t)</pre>	<p>PLS_INTEGER: Number of owners of objects modified in event</p> <p>OUT parameter: List of owners of objects modified in event</p>	<pre>DECLARE owner_list ora_name_list_t; number_modified PLS_INTEGER; BEGIN IF (ora_sysevent='ASSOCIATE STATISTICS') THEN number_modified := ora_dict_obj_name_list(owner_list); END IF; END;</pre>
<pre>ora_dict_obj_type</pre>	<p>VARCHAR2 (20): Type of dictionary object on which DDL operation occurred</p>	<pre>INSERT INTO event_table VALUES ('This object is a ' ora_dict_obj_type);</pre>
<pre>ora_grantee (user_list OUT ora_name_list_t)</pre>	<p>PLS_INTEGER: Number of grantees in grant event</p> <p>OUT parameter: List of grantees in grant event</p>	<pre>DECLARE user_list ora_name_list_t; number_of_grantees PLS_INTEGER; BEGIN IF (ora_sysevent = 'GRANT') THEN number_of_grantees := ora_grantee(user_list); END IF; END;</pre>
<pre>ora_instance_num</pre>	<p>NUMBER: Instance number</p>	<pre>IF (ora_instance_num = 1) THEN INSERT INTO event_table VALUES ('1'); END IF;</pre>
<pre>ora_is_alter_column (column_name IN VARCHAR2)</pre>	<p>BOOLEAN: TRUE if specified column is altered, FALSE otherwise</p>	<pre>IF (ora_sysevent = 'ALTER' AND ora_dict_obj_type = 'TABLE') THEN alter_column := ora_is_alter_column('C'); END IF;</pre>
<pre>ora_is_creating_nested_table</pre>	<p>BOOLEAN: TRUE if current event is creating nested table, FALSE otherwise</p>	<pre>IF (ora_sysevent = 'CREATE' AND ora_dict_obj_type = 'TABLE' AND ora_is_creating_nested_table) THEN INSERT INTO event_table VALUES ('A nested table is created'); END IF;</pre>
<pre>ora_is_drop_column (column_name IN VARCHAR2)</pre>	<p>BOOLEAN: TRUE if specified column is dropped, FALSE otherwise</p>	<pre>IF (ora_sysevent = 'ALTER' AND ora_dict_obj_type = 'TABLE') THEN drop_column := ora_is_drop_column('C'); END IF;</pre>

Table 9-5 (Cont.) System-Defined Event Attributes

Attribute	Return Type and Value	Example
<code>ora_is_servererror (error_number IN VARCHAR2)</code>	BOOLEAN: TRUE if given error is on error stack, FALSE otherwise	<pre>IF ora_is_servererror(error_number) THEN INSERT INTO event_table VALUES ('Server error!!'); END IF;</pre>
<code>ora_login_user</code>	VARCHAR2 (128): Login user name	<pre>SELECT ora_login_user FROM DUAL;</pre>
<code>ora_partition_pos</code>	PLS_INTEGER: In INSTEAD OF trigger for CREATE TABLE, position in SQL text where you can insert PARTITION clause	<pre>-- Retrieve ora_sql_txt into sql_text variable v_n := ora_partition_pos; v_new_stmt := SUBSTR(sql_text,1,v_n - 1) ' ' my_partition_clause ' ' SUBSTR(sql_text, v_n));</pre>
<code>ora_privilege_list (privilege_list OUT ora_name_list_t)</code>	PLS_INTEGER: Number of privileges in grant or revoke event OUT parameter: List of privileges granted or revoked in event	<pre>DECLARE privilege_list ora_name_list_t; number_of_privileges PLS_INTEGER; BEGIN IF (ora_sysevent = 'GRANT' OR ora_sysevent = 'REVOKE') THEN number_of_privileges := ora_privilege_list(privilege_list); END IF; END;</pre>
<code>ora_revokee (user_list OUT ora_name_list_t)</code>	PLS_INTEGER: Number of revokees in revoke event OUT parameter: List of revokees in event	<pre>DECLARE user_list ora_name_list_t; number_of_users PLS_INTEGER; BEGIN IF (ora_sysevent = 'REVOKE') THEN number_of_users := ora_revokee(user_list); END IF; END;</pre>
<code>ora_server_error (position IN PLS_INTEGER)</code>	NUMBER: Error code at given position on error stack ¹	<pre>INSERT INTO event_table VALUES ('top stack error ' ora_server_error(1));</pre>
<code>ora_server_error_depth</code>	PLS_INTEGER: Number of error messages on error stack	<pre>n := ora_server_error_depth; -- Use n with functions such as ora_server_error</pre>
<code>ora_server_error_msg (position IN PLS_INTEGER)</code>	VARCHAR2: Error message at given position on error stack ¹	<pre>INSERT INTO event_table VALUES ('top stack error message' ora_server_error_msg(1));</pre>

Table 9-5 (Cont.) System-Defined Event Attributes

Attribute	Return Type and Value	Example
ora_server_error_num_params (position IN PLS_INTEGER)	PLS_INTEGER: Number of strings substituted into error message (using format like %s) at given position on error stack ¹	n := ora_server_error_num_params(1);
ora_server_error_param (position IN PLS_INTEGER, param IN PLS_INTEGER)	VARCHAR2: Matching substitution value (%s, %d, and so on) in error message at given position and parameter number ¹	-- Second %s in "Expected %s, found %s": param := ora_server_error_param(1,2);
ora_sql_txt (sql_text OUT ora_name_list_t)	PLS_INTEGER: Number of elements in PL/SQL table OUT parameter: SQL text of triggering statement (broken into multiple collection elements if statement is long)	CREATE TABLE event_table (col VARCHAR2(2030)); DECLARE sql_text ora_name_list_t; n PLS_INTEGER; v_stmt VARCHAR2(2000); BEGIN n := ora_sql_txt(sql_text); FOR i IN 1..n LOOP v_stmt := v_stmt sql_text(i); END LOOP; INSERT INTO event_table VALUES ('text of triggering statement: ' v_stmt); END;
ora_sysevent	VARCHAR2(20): Name of triggering event, as given in syntax	INSERT INTO event_table VALUES (ora_sysevent);
ora_with_grant_option	BOOLEAN: TRUE if privileges are granted with GRANT option, FALSE otherwise	IF (ora_sysevent = 'GRANT' AND ora_with_grant_option = TRUE) THEN INSERT INTO event_table VALUES ('with grant option'); END IF;
ora_space_error_info (error_number OUT NUMBER, error_type OUT VARCHAR2, object_owner OUT VARCHAR2, table_space_name OUT VARCHAR2, object_name OUT VARCHAR2, sub_object_name OUT VARCHAR2)	BOOLEAN: TRUE if error is related to out-of-space condition, FALSE otherwise OUT parameters: Information about object that caused error	IF (ora_space_error_info (eno,typ,owner,ts,obj,subobj) = TRUE) THEN DBMS_OUTPUT.PUT_LINE('The object ' obj ' owned by ' owner ' has run out of space.');

¹ Position 1 is the top of the stack.

9.15.2 Event Attribute Functions for Database Event Triggers

[Table 9-6](#) summarizes the database event triggers that can invoke event attribute functions. For more information about the triggering events in [Table 9-6](#), see "[database_event](#)".

Table 9-6 Database Event Triggers

Triggering Event	When Trigger Fires	WHEN Conditions	Restrictions	Transaction	Attribute Functions
AFTER STARTUP	When database is opened.	None allowed	Trigger cannot do database operations.	Starts a separate transaction and commits it after firing the triggers.	ora_sysevent ora_login_user ora_instance_number ora_database_name
BEFORE SHUTDOWN	Just before server starts shutdown of an instance. This lets the cartridge shutdown completely. For abnormal instance shutdown, this trigger might not fire.	None allowed	Trigger cannot do database operations.	Starts separate transaction and commits it after firing triggers.	ora_sysevent ora_login_user ora_instance_number ora_database_name
AFTER DB_ROLE_CHANGE	When database is opened for first time after role change.	None allowed	None	Starts separate transaction and commits it after firing triggers.	ora_sysevent ora_login_user ora_instance_number ora_database_name
AFTER SERVERERROR	With condition, whenever specified error occurs. Without condition, whenever any error occurs. Trigger does not fire for errors listed in " database_event ".	ERRNO = eno	Depends on error.	Starts separate transaction and commits it after firing triggers.	ora_sysevent ora_login_user ora_instance_number ora_database_name ora_server_error ora_is_servererror ora_space_error_info

9.15.3 Event Attribute Functions for Client Event Triggers

[Table 9-7](#) summarizes the client event triggers that can invoke event attribute functions. For more information about the triggering events in [Table 9-7](#), see "[ddl_event](#)" and "[database_event](#)".



Note:

If a client event trigger becomes the target of a DDL operation (such as CREATE OR REPLACE TRIGGER), then it cannot fire later during the same transaction.

Table 9-7 Client Event Triggers

Triggering Event	When Trigger Fires	WHEN Conditions	Restrictions	Transaction	Attribute Functions
BEFORE ALTER AFTER ALTER	When catalog object is altered	Simple conditions on type and name of object, UID, and USER	Trigger cannot do DDL operations on object that caused event to be generated. DDL on other objects is limited to compiling an object, creating a trigger, and creating, altering, and dropping a table.	Fires triggers in current transaction.	ora_sysevent ora_login_user ora_instance_num ora_database_name ora_dict_obj_type ora_dict_obj_name ora_dict_obj_owner ora_des_encrypted_password (for ALTER USER events) ora_is_alter_column (for ALTER TABLE events) ora_is_drop_column (for ALTER TABLE events)
BEFORE DROP AFTER DROP	When catalog object is dropped	Simple conditions on type and name of object, UID, and USER	Trigger cannot do DDL operations on object that caused event to be generated. DDL on other objects is limited to compiling an object, creating a trigger, and creating, altering, and dropping a table.	Fires triggers in current transaction.	ora_sysevent ora_login_user ora_instance_num ora_database_name ora_dict_obj_type ora_dict_obj_name ora_dict_obj_owner

Table 9-7 (Cont.) Client Event Triggers

Triggering Event	When Trigger Fires	WHEN Conditions	Restrictions	Transaction	Attribute Functions
BEFORE ANALYZE AFTER ANALYZE	When ANALYZE statement is issued	Simple conditions on type and name of object, UID, and USER	Trigger cannot do DDL operations on object that caused event to be generated. DDL on other objects is limited to compiling an object, creating a trigger, and creating, altering, and dropping a table.	Fires triggers in current transaction.	ora_sysevent ora_login_user ora_instance_num ora_database_name ora_dict_obj_name ora_dict_obj_type ora_dict_obj_owner
BEFORE ASSOCIATE STATISTICS AFTER ASSOCIATE STATISTICS	When ASSOCIATE STATISTICS statement is issued	Simple conditions on type and name of object, UID, and USER	Trigger cannot do DDL operations on object that caused event to be generated. DDL on other objects is limited to compiling an object, creating a trigger, and creating, altering, and dropping a table.	Fires triggers in current transaction.	ora_sysevent ora_login_user ora_instance_num ora_database_name ora_dict_obj_name ora_dict_obj_type ora_dict_obj_owner ora_dict_obj_name_list ora_dict_obj_owner_list
BEFORE AUDIT AFTER AUDIT BEFORE NOAUDIT AFTER NOAUDIT	When AUDIT or NOAUDIT statement is issued	Simple conditions on type and name of object, UID, and USER	Trigger cannot do DDL operations on object that caused event to be generated. DDL on other objects is limited to compiling an object, creating a trigger, and creating, altering, and dropping a table.	Fires triggers in current transaction.	ora_sysevent ora_login_user ora_instance_num ora_database_name

Table 9-7 (Cont.) Client Event Triggers

Triggering Event	When Trigger Fires	WHEN Conditions	Restrictions	Transaction	Attribute Functions
BEFORE COMMENT AFTER COMMENT	When object is commented	Simple conditions on type and name of object, UID, and USER	Trigger cannot do DDL operations on object that caused event to be generated. DDL on other objects is limited to compiling an object, creating a trigger, and creating, altering, and dropping a table.	Fires triggers in current transaction.	ora_sysevent ora_login_user ora_instance_num ora_database_name ora_dict_obj_name ora_dict_obj_type ora_dict_obj_owner
BEFORE CREATE AFTER CREATE	When catalog object is created	Simple conditions on type and name of object, UID, and USER	Trigger cannot do DDL operations on object that caused event to be generated. DDL on other objects is limited to compiling an object, creating a trigger, and creating, altering, and dropping a table.	Fires triggers in current transaction.	ora_sysevent ora_login_user ora_instance_num ora_database_name ora_dict_obj_type ora_dict_obj_name ora_dict_obj_owner ora_is_creating_nested_table (for CREATE TABLE events)
BEFORE DDL AFTER DDL	When most SQL DDL statements are issued. Not fired for ALTER DATABASE, CREATE CONTROLFILE, CREATE DATABASE, and DDL issued through the PL/SQL subprogram interface, such as creating an advanced queue.	Simple conditions on type and name of object, UID, and USER	Trigger cannot do DDL operations on object that caused event to be generated. DDL on other objects is limited to compiling an object, creating a trigger, and creating, altering, and dropping a table.	Fires triggers in current transaction.	ora_sysevent ora_login_user ora_instance_num ora_database_name ora_dict_obj_name ora_dict_obj_type ora_dict_obj_owner

Table 9-7 (Cont.) Client Event Triggers

Triggering Event	When Trigger Fires	WHEN Conditions	Restrictions	Transaction	Attribute Functions
BEFORE DISASSOCIATE STATISTICS	When DISASSOCIATE STATISTICS statement is issued	Simple conditions on type and name of object, UID, and USER	Trigger cannot do DDL operations on object that caused event to be generated. DDL on other objects is limited to compiling an object, creating a trigger, and creating, altering, and dropping a table.	Fires triggers in current transaction.	ora_sysevent ora_login_user ora_instance_num ora_database_name ora_dict_obj_name ora_dict_obj_type ora_dict_obj_owner ora_dict_obj_name_list ora_dict_obj_owner_list
AFTER DISASSOCIATE STATISTICS					
BEFORE GRANT	When GRANT statement is issued	Simple conditions on type and name of object, UID, and USER	Trigger cannot do DDL operations on object that caused event to be generated. DDL on other objects is limited to compiling an object, creating a trigger, and creating, altering, and dropping a table.	Fires triggers in current transaction.	ora_sysevent ora_login_user ora_instance_num ora_database_name ora_dict_obj_name ora_dict_obj_type ora_dict_obj_owner ora_grantee ora_with_grant_option ora_privilege_list
AFTER GRANT					
BEFORE LOGOFF	At start of user logoff	Simple conditions on UID and USER	DDL on other objects is limited to compiling an object, creating a trigger, and creating, altering, and dropping a table.	Fires triggers in current transaction.	ora_sysevent ora_login_user ora_instance_num ora_database_name
AFTER LOGON	After successful user logon	Simple conditions on UID and USER	DDL on other objects is limited to compiling an object, creating a trigger, and creating, altering, and dropping a table.	Starts separate transaction and commits it after firing triggers.	ora_sysevent ora_login_user ora_instance_num ora_database_name ora_client_ip_address

Table 9-7 (Cont.) Client Event Triggers

Triggering Event	When Trigger Fires	WHEN Conditions	Restrictions	Transaction	Attribute Functions
BEFORE RENAME AFTER RENAME	When RENAME statement is issued	Simple conditions on type and name of object, UID, and USER	Trigger cannot do DDL operations on object that caused event to be generated. DDL on other objects is limited to compiling an object, creating a trigger, and creating, altering, and dropping a table.	Fires triggers in current transaction.	ora_sysevent ora_login_user ora_instance_num ora_database_name ora_dict_obj_name ora_dict_obj_owner ora_dict_obj_type
BEFORE REVOKE AFTER REVOKE	When REVOKE statement is issued	Simple conditions on type and name of object, UID, and USER	Trigger cannot do DDL operations on object that caused event to be generated. DDL on other objects is limited to compiling an object, creating a trigger, and creating, altering, and dropping a table.	Fires triggers in current transaction.	ora_sysevent ora_login_user ora_instance_num ora_database_name ora_dict_obj_name ora_dict_obj_type ora_dict_obj_owner ora_revokee ora_privilege_list
AFTER SUSPEND	After SQL statement is suspended because of out-of-space condition. (Trigger must correct condition so statement can be resumed.)	Simple conditions on type and name of object, UID, and USER	Trigger cannot do DDL operations on object that caused event to be generated. DDL on other objects is limited to compiling an object, creating a trigger, and creating, altering, and dropping a table.	Fires triggers in current transaction.	ora_sysevent ora_login_user ora_instance_num ora_database_name ora_server_error ora_is_servererror ora_space_error_info

Table 9-7 (Cont.) Client Event Triggers

Triggering Event	When Trigger Fires	WHEN Conditions	Restrictions	Transaction	Attribute Functions
BEFORE TRUNCATE	When object is truncated	Simple conditions on type and name of object, UID, and USER	Trigger cannot do DDL operations on object that caused event to be generated. DDL on other objects is limited to compiling an object, creating a trigger, and creating, altering, and dropping a table.	Fires triggers in current transaction.	ora_sysevent ora_login_user ora_instance_num ora_database_name ora_dict_obj_name ora_dict_obj_type ora_dict_obj_owner

9.16 Views for Information About Triggers

The *_TRIGGERS static data dictionary views reveal information about triggers. For information about these views, see *Oracle Database Reference*.

Example 9-28 Viewing Information About Triggers

This example creates a trigger and queries the static data dictionary view USER_TRIGGERS twice—first to show its type, triggering event, and the name of the table on which it is created, and then to show its body.

```
CREATE OR REPLACE TRIGGER Emp_count
  AFTER DELETE ON employees
DECLARE
  n INTEGER;
BEGIN
  SELECT COUNT(*) INTO n FROM employees;
  DBMS_OUTPUT.PUT_LINE('There are now ' || n || ' employees.');
```

These SQL*Plus commands format the query results.

```
COLUMN Trigger_type FORMAT A15
COLUMN Triggering_event FORMAT A16
COLUMN Table_name FORMAT A11
COLUMN Trigger_body FORMAT A50
SET LONG 9999
```

Query:

```
SELECT Trigger_type, Triggering_event, Table_name
FROM USER_TRIGGERS
WHERE Trigger_name = 'EMP_COUNT';
```

Result:

```
TRIGGER_TYPE    TRIGGERING_EVENT TABLE_NAME
-----
AFTER STATEMENT DELETE          EMPLOYEES
```

Query:

```
SELECT Trigger_body
FROM USER_TRIGGERS
WHERE Trigger_name = 'EMP_COUNT';
```

Result:

```
TRIGGER_BODY
-----
DECLARE
  n INTEGER;
BEGIN
  SELECT COUNT(*) INTO n FROM employees;
  DBMS_OUTPUT.PUT_LINE('There are now ' || n || '
employees.');
```

10

PL/SQL Packages

This chapter explains how to bundle related PL/SQL code and data into a package, whose contents are available to many applications.

Topics

- [What is a Package?](#)
- [Reasons to Use Packages](#)
- [Package Specification](#)
- [Package Body](#)
- [Package Instantiation and Initialization](#)
- [Package State](#)
- [SERIALLY_REUSABLE Packages](#)
- [Package Writing Guidelines](#)
- [Package Example](#)
- [How STANDARD Package Defines the PL/SQL Environment](#)

10.1 What is a Package?

A **package** is a schema object that groups logically related PL/SQL types, variables, constants, subprograms, cursors, and exceptions. A package is compiled and stored in the database, where many applications can share its contents.

A package always has a **specification**, which declares the **public items** that can be referenced from outside the package.

If the public items include cursors or subprograms, then the package must also have a **body**. The body must define queries for public cursors and code for public subprograms. The body can also declare and define **private items** that cannot be referenced from outside the package, but are necessary for the internal workings of the package. Finally, the body can have an **initialization part**, whose statements initialize variables and do other one-time setup steps, and an exception-handling part. You can change the body without changing the specification or the references to the public items; therefore, you can think of the package body as a black box.

In either the package specification or package body, you can map a package subprogram to an external Java or C subprogram by using a **call specification**, which maps the external subprogram name, parameter types, and return type to their SQL counterparts.

The **AUTHID clause** of the package specification determines whether the subprograms and cursors in the package run with the privileges of their definer (the default) or invoker, and whether their unqualified references to schema objects are resolved in the schema of the definer or invoker.

The **ACCESSIBLE BY clause** of the package specification lets you specify a white list of PL/SQL units that can access the package. You use this clause in situations like these:

- You implement a PL/SQL application as several packages—one package that provides the application programming interface (API) and helper packages to do the work. You want clients to have access to the API, but not to the helper packages. Therefore, you omit the **ACCESSIBLE BY** clause from the API package specification and include it in each helper package specification, where you specify that only the API package can access the helper package.
- You create a utility package to provide services to some, but not all, PL/SQL units in the same schema. To restrict use of the package to the intended units, you list them in the **ACCESSIBLE BY** clause in the package specification.

See Also:

- "[Package Specification](#)" for more information about the package specification
- "[Package Body](#)" for more information about the package body
- "[Function Declaration and Definition](#)"
- "[Procedure Declaration and Definition](#)"
- "[Invoker's Rights and Definer's Rights \(AUTHID Property\)](#)"

10.2 Reasons to Use Packages

Packages support the development and maintenance of reliable, reusable code with the following features:

- **Modularity**

Packages let you encapsulate logically related types, variables, constants, subprograms, cursors, and exceptions in named PL/SQL modules. You can make each package easy to understand, and make the interfaces between packages simple, clear, and well defined. This practice aids application development.
- **Easier Application Design**

When designing an application, all you need initially is the interface information in the package specifications. You can code and compile specifications without their bodies. Next, you can compile standalone subprograms that reference the packages. You need not fully define the package bodies until you are ready to complete the application.
- **Hidden Implementation Details**

Packages let you share your interface information in the package specification, and hide the implementation details in the package body. Hiding the implementation details in the body has these advantages:

 - You can change the implementation details without affecting the application interface.
 - Application users cannot develop code that depends on implementation details that you might want to change.

- **Added Functionality**

Package public variables and cursors can persist for the life of a session. They can be shared by all subprograms that run in the environment. They let you maintain data across transactions without storing it in the database. (For the situations in which package public variables and cursors do not persist for the life of a session, see "[Package State](#)".)

- **Better Performance**

The first time you invoke a package subprogram, Oracle Database loads the whole package into memory. Subsequent invocations of other subprograms in same the package require no disk I/O.

Packages prevent cascading dependencies and unnecessary recompiling. For example, if you change the body of a package function, Oracle Database does not recompile other subprograms that invoke the function, because these subprograms depend only on the parameters and return value that are declared in the specification.

- **Easier to Grant Roles**

You can grant roles on the package, instead of granting roles on each object in the package.

**Note:**

You cannot reference host variables from inside a package.

10.3 Package Specification

A **package specification** declares **public items**. The scope of a public item is the schema of the package. A public item is visible everywhere in the schema. To reference a public item that is in scope but not visible, qualify it with the package name. (For information about scope, visibility, and qualification, see "[Scope and Visibility of Identifiers](#)".)

Each public item declaration has all information needed to use the item. For example, suppose that a package specification declares the function `factorial` this way:

```
FUNCTION factorial (n INTEGER) RETURN INTEGER; -- returns n!
```

The declaration shows that `factorial` needs one argument of type `INTEGER` and returns a value of type `INTEGER`, which is invokers must know to invoke `factorial`. Invokers need not know how `factorial` is implemented (for example, whether it is iterative or recursive).

**Note:**

To restrict the use of your package to specified PL/SQL units, include the `ACCESSIBLE BY` clause in the package specification.

Topics

- [Appropriate Public Items](#)
- [Creating Package Specifications](#)

10.3.1 Appropriate Public Items

Appropriate public items are:

- Types, variables, constants, subprograms, cursors, and exceptions used by multiple subprograms

A type defined in a package specification is either a PL/SQL user-defined subtype (described in "[User-Defined PL/SQL Subtypes](#)") or a PL/SQL composite type (described in [PL/SQL Collections and Records](#)).

 **Note:**

A PL/SQL composite type defined in a package specification is incompatible with an identically defined local or standalone type (see [Example 5-33](#), [Example 5-34](#), and [Example 5-39](#)).

- Associative array types of standalone subprogram parameters
You cannot declare an associative array type at schema level. Therefore, to pass an associative array variable as a parameter to a standalone subprogram, you must declare the type of that variable in a package specification. Doing so makes the type available to both the invoked subprogram (which declares a formal parameter of that type) and to the invoking subprogram or anonymous block (which declares a variable of that type). See [Example 10-2](#).
- Variables that must remain available between subprogram invocations in the same session
- Subprograms that read and write public variables ("get" and "set" subprograms)
Provide these subprograms to discourage package users from reading and writing public variables directly.
- Subprograms that invoke each other
You need not worry about compilation order for package subprograms, as you must for standalone subprograms that invoke each other.
- Overloaded subprograms
Overloaded subprograms are variations of the same subprogram. That is, they have the same name but different formal parameters. For more information about them, see "[Overloaded Subprograms](#)".

 **Note:**

You cannot reference remote package public variables, even indirectly. For example, if a subprogram refers to a package public variable, you cannot invoke the subprogram through a database link.

10.3.2 Creating Package Specifications

To create a package specification, use the "CREATE PACKAGE Statement".

Because the package specifications in [Example 10-1](#) and [Example 10-2](#) do not declare cursors or subprograms, the packages `trans_data` and `aa_pkg` do not need bodies.

Example 10-1 Simple Package Specification

In this example, the specification for the package `trans_data` declares two public types and three public variables.

```
CREATE OR REPLACE PACKAGE trans_data AUTHID DEFINER AS
  TYPE TimeRec IS RECORD (
    minutes SMALLINT,
    hours    SMALLINT);
  TYPE TransRec IS RECORD (
    category VARCHAR2(10),
    account  INT,
    amount   REAL,
    time_of  TimeRec);
  minimum_balance    CONSTANT REAL := 10.00;
  number_processed   INT;
  insufficient_funds EXCEPTION;
  PRAGMA EXCEPTION_INIT(insufficient_funds, -4097);
END trans_data;
/
```

Example 10-2 Passing Associative Array to Standalone Subprogram

In this example, the specification for the package `aa_pkg` declares an associative array type, `aa_type`. Then, the standalone procedure `print_aa` declares a formal parameter of type `aa_type`. Next, the anonymous block declares a variable of type `aa_type`, populates it, and passes it to the procedure `print_aa`, which prints it.

```
CREATE OR REPLACE PACKAGE aa_pkg AUTHID DEFINER IS
  TYPE aa_type IS TABLE OF INTEGER INDEX BY VARCHAR2(15);
END;
/
CREATE OR REPLACE PROCEDURE print_aa (
  aa aa_pkg.aa_type
) AUTHID DEFINER IS
  i VARCHAR2(15);
BEGIN
  i := aa.FIRST;

  WHILE i IS NOT NULL LOOP
    DBMS_OUTPUT.PUT_LINE (aa(i) || ' ' || i);
    i := aa.NEXT(i);
  END LOOP;
END;
/
DECLARE
  aa_var aa_pkg.aa_type;
BEGIN
  aa_var('zero') := 0;
  aa_var('one')  := 1;
  aa_var('two')  := 2;
  print_aa(aa_var);
END;
```



```
END;
/
```

Result:

```
1 one
2 two
0 zero
```

10.4 Package Body

If a package specification declares cursors or subprograms, then a package body is required; otherwise, it is optional. The package body and package specification must be in the same schema.

Every cursor or subprogram declaration in the package specification must have a corresponding definition in the package body. The headings of corresponding subprogram declarations and definitions must match word for word, except for white space.

To create a package body, use the "[CREATE PACKAGE BODY Statement](#)".

The cursors and subprograms declared in the package specification and defined in the package body are public items that can be referenced from outside the package. The package body can also declare and define **private items** that cannot be referenced from outside the package, but are necessary for the internal workings of the package.

Finally, the body can have an **initialization part**, whose statements initialize public variables and do other one-time setup steps. The initialization part runs only the first time the package is referenced. The initialization part can include an exception handler.

You can change the package body without changing the specification or the references to the public items.

Example 10-3 Matching Package Specification and Body

In this example, the headings of the corresponding subprogram declaration and definition do not match word for word; therefore, PL/SQL raises an exception, even though `employees.hire_date%TYPE` is `DATE`.

```
CREATE PACKAGE emp_bonus AS
  PROCEDURE calc_bonus (date_hired employees.hire_date%TYPE);
END emp_bonus;
/
CREATE PACKAGE BODY emp_bonus AS
  -- DATE does not match employees.hire_date%TYPE
  PROCEDURE calc_bonus (date_hired DATE) IS
  BEGIN
    DBMS_OUTPUT.PUT_LINE
      ('Employees hired on ' || date_hired || ' get bonus. ');
  END;
END emp_bonus;
/
```

Result:

```
Warning: Package Body created with compilation errors.
```

Show errors (in SQL*Plus):

```
SHOW ERRORS
```

Result:

```
Errors for PACKAGE BODY EMP_BONUS:
```

```
LINE/COL ERROR
```

```
-----  
2/13      PLS-00323: subprogram or cursor 'CALC_BONUS' is declared in a  
          package specification and must be defined in the package body
```

Correct problem:

```
CREATE OR REPLACE PACKAGE BODY emp_bonus AS  
  PROCEDURE calc_bonus  
    (date_hired employees.hire_date%TYPE) IS  
  BEGIN  
    DBMS_OUTPUT.PUT_LINE  
      ('Employees hired on ' || date_hired || ' get bonus.');
```

Result:

```
Package body created.
```

10.5 Package Instantiation and Initialization

When a session references a package item, Oracle Database instantiates the package for that session. Every session that references a package has its own instantiation of that package.

When Oracle Database instantiates a package, it initializes it. Initialization includes whichever of the following are applicable:

- Assigning initial values to public constants
- Assigning initial values to public variables whose declarations specify them
- Executing the initialization part of the package body

10.6 Package State

The values of the variables, constants, and cursors that a package declares (in either its specification or body) comprise its **package state**.

If a PL/SQL package declares at least one variable, constant, or cursor, then the package is **stateful**; otherwise, it is **stateless**.

Each session that references a package item has its own instantiation of that package. If the package is stateful, the instantiation includes its state.

The package state persists for the life of a session, except in these situations:

- The package is `SERIALLY_REUSABLE`.
- The package body is recompiled.

If the body of an instantiated, stateful package is recompiled (either explicitly, with the ["ALTER PACKAGE Statement"](#), or implicitly), the next invocation of a subprogram in the package causes Oracle Database to discard the existing package state and raise the exception ORA-04068.

After PL/SQL raises the exception, a reference to the package causes Oracle Database to re-instantiate the package, which re-initializes it. Therefore, previous changes to the package state are lost.

- Any of the session's instantiated packages are invalidated and revalidated.
All of a session's package instantiations (including package states) can be lost if any of the session's instantiated packages are invalidated and revalidated.

Oracle Database treats a package as stateless if its state is constant for the life of a session (or longer). This is the case for a package whose items are all compile-time constants.

A **compile-time constant** is a constant whose value the PL/SQL compiler can determine at compilation time. A constant whose initial value is a literal is always a compile-time constant. A constant whose initial value is not a literal, but which the optimizer reduces to a literal, is also a compile-time constant. Whether the PL/SQL optimizer can reduce a nonliteral expression to a literal depends on optimization level. Therefore, a package that is stateless when compiled at one optimization level might be stateful when compiled at a different optimization level.

See Also:

- ["SERIALLY_REUSABLE Packages"](#)
- ["Package Instantiation and Initialization"](#) for information about initialization
- *Oracle Database Development Guide* for information about invalidation and revalidation of schema objects
- ["PL/SQL Optimizer"](#) for information about the optimizer

10.7 SERIALLY_REUSABLE Packages

`SERIALLY_REUSABLE` packages let you design applications that manage memory better for scalability.

If a package is not `SERIALLY_REUSABLE`, its package state is stored in the user global area (UGA) for each user. Therefore, the amount of UGA memory needed increases linearly with the number of users, limiting scalability. The package state can persist for the life of a session, locking UGA memory until the session ends. In some applications, such as Oracle Office, a typical session lasts several days.

If a package is `SERIALLY_REUSABLE`, its package state is stored in a work area in a small pool in the system global area (SGA). The package state persists only for the life of a server call. After the server call, the work area returns to the pool. If a subsequent server call references the package, then Oracle Database reuses an instantiation from the pool. Reusing an instantiation re-initializes it; therefore, changes made to the package state in previous server calls are invisible. (For information about initialization, see ["Package Instantiation and Initialization"](#).)

**Note:**

Trying to access a `SERIALLY_REUSABLE` package from a database trigger, or from a PL/SQL subprogram invoked by a SQL statement, raises an error.

Topics

- [Creating SERIALLY_REUSABLE Packages](#)
- [SERIALLY_REUSABLE Package Work Unit](#)
- [Explicit Cursors in SERIALLY_REUSABLE Packages](#)

10.7.1 Creating SERIALLY_REUSABLE Packages

To create a `SERIALLY_REUSABLE` package, include the `SERIALLY_REUSABLE` pragma in the package specification and, if it exists, the package body.

[Example 10-4](#) creates two very simple `SERIALLY_REUSABLE` packages, one with only a specification, and one with both a specification and a body.

**See Also:**

["SERIALLY_REUSABLE Pragma"](#)

Example 10-4 Creating SERIALLY_REUSABLE Packages

```
-- Create bodiless SERIALLY_REUSABLE package:

CREATE OR REPLACE PACKAGE bodiless_pkg AUTHID DEFINER IS
  PRAGMA SERIALLY_REUSABLE;
  n NUMBER := 5;
END;
/

-- Create SERIALLY_REUSABLE package with specification and body:

CREATE OR REPLACE PACKAGE pkg AUTHID DEFINER IS
  PRAGMA SERIALLY_REUSABLE;
  n NUMBER := 5;
END;
/

CREATE OR REPLACE PACKAGE BODY pkg IS
  PRAGMA SERIALLY_REUSABLE;
BEGIN
  n := 5;
END;
/
```

10.7.2 SERIALLY_REUSABLE Package Work Unit

For a `SERIALLY_REUSABLE` package, the work unit is a server call.

You must use its public variables only within the work unit.

**Note:**

If you make a mistake and depend on the value of a public variable that was set in a previous work unit, then your program can fail. PL/SQL cannot check for such cases.

After the work unit (server call) of a `SERIALLY_REUSABLE` package completes, Oracle Database does the following:

- Closes any open cursors.
- Frees some nonreusable memory (for example, memory for collection and long VARCHAR2 variables)
- Returns the package instantiation to the pool of reusable instantiations kept for this package.

Example 10-5 Effect of SERIALLY_REUSABLE Pragma

In this example, the bodiless packages `pkg` and `sr_pkg` are the same, except that `sr_pkg` is `SERIALLY_REUSABLE` and `pkg` is not. Each package declares public variable `n` with initial value 5. Then, an anonymous block changes the value of each variable to 10. Next, another anonymous block prints the value of each variable. The value of `pkg.n` is still 10, because the state of `pkg` persists for the life of the session. The value of `sr_pkg.n` is 5, because the state of `sr_pkg` persists only for the life of the server call.

```
CREATE OR REPLACE PACKAGE pkg IS
  n NUMBER := 5;
END pkg;
/

CREATE OR REPLACE PACKAGE sr_pkg IS
  PRAGMA SERIALLY_REUSABLE;
  n NUMBER := 5;
END sr_pkg;
/

BEGIN
  pkg.n := 10;
  sr_pkg.n := 10;
END;
/

BEGIN
  DBMS_OUTPUT.PUT_LINE('pkg.n: ' || pkg.n);
  DBMS_OUTPUT.PUT_LINE('sr_pkg.n: ' || sr_pkg.n);
END;
/
```

Result:

```
pkg.n: 10
sr_pkg.n: 5
```

10.7.3 Explicit Cursors in SERIALLY_REUSABLE Packages

An explicit cursor in a `SERIALLY_REUSABLE` package remains open until either you close it or its work unit (server call) ends. To re-open the cursor, you must make a new server call. A server call can be different from a subprogram invocation, as [Example 10-6](#) shows.

In contrast, an explicit cursor in a package that is not `SERIALLY_REUSABLE` remains open until you either close it or disconnect from the session.

Example 10-6 Cursor in SERIALLY_REUSABLE Package Open at Call Boundary

```
DROP TABLE people;
CREATE TABLE people (name VARCHAR2(20));

INSERT INTO people (name) VALUES ('John Smith');
INSERT INTO people (name) VALUES ('Mary Jones');
INSERT INTO people (name) VALUES ('Joe Brown');
INSERT INTO people (name) VALUES ('Jane White');

CREATE OR REPLACE PACKAGE sr_pkg IS
    PRAGMA SERIALLY_REUSABLE;
    CURSOR c IS SELECT name FROM people;
END sr_pkg;
/

CREATE OR REPLACE PROCEDURE fetch_from_cursor IS
    v_name people.name%TYPE;
BEGIN
    IF sr_pkg.c%ISOPEN THEN
        DBMS_OUTPUT.PUT_LINE('Cursor is open.');
```

```
    ELSE
        DBMS_OUTPUT.PUT_LINE('Cursor is closed; opening now.');
```

```
        OPEN sr_pkg.c;
    END IF;

    FETCH sr_pkg.c INTO v_name;
    DBMS_OUTPUT.PUT_LINE('Fetched: ' || v_name);

    FETCH sr_pkg.c INTO v_name;
    DBMS_OUTPUT.PUT_LINE('Fetched: ' || v_name);
END fetch_from_cursor;
/
```

First call to server:

```
BEGIN
    fetch_from_cursor;
    fetch_from_cursor;
END;
/
```

Result:

Cursor is closed; opening now.

Fetched: John Smith

Fetched: Mary Jones

Cursor is open.

Fetched: Joe Brown

Fetches: Jane White

New call to server:

```
BEGIN
  fetch_from_cursor;
  fetch_from_cursor;
END;
/
```

Result:

Cursor is closed; opening now.

Fetches: John Smith

Fetches: Mary Jones

Cursor is open.

Fetches: Joe Brown

Fetches: Jane White

10.8 Package Writing Guidelines

- Become familiar with the packages that Oracle Database supplies, and avoid writing packages that duplicate their features.

For more information about the packages that Oracle Database supplies, see *Oracle Database PL/SQL Packages and Types Reference*.

- Keep your packages general so that future applications can reuse them.
- Design and define the package specifications before the package bodies.
- In package specifications, declare only items that must be visible to invoking programs.

This practice prevents other developers from building unsafe dependencies on your implementation details and reduces the need for recompilation.

If you change the package specification, you must recompile any subprograms that invoke the public subprograms of the package. If you change only the package body, you need not recompile those subprograms.

- Declare public cursors in package specifications and define them in package bodies, as in [Example 10-7](#).

This practice lets you hide cursors' queries from package users and change them without changing cursor declarations.

- Assign initial values in the initialization part of the package body instead of in declarations.

This practice has these advantages:

- The code for computing the initial values can be more complex and better documented.
- If computing an initial value raises an exception, the initialization part can handle it with its own exception handler.
- If you implement a database application as several PL/SQL packages—one package that provides the API and helper packages to do the work, then make the helper packages available only to the API package, as in [Example 10-8](#).

In [Example 10-7](#), the declaration and definition of the cursor `c1` are in the specification and body, respectively, of the package `emp_stuff`. The cursor declaration specifies only the data type of the return value, not the query, which appears in the cursor definition (for complete syntax and semantics, see "[Explicit Cursor Declaration and Definition](#)").

[Example 10-8](#) creates an API package and a helper package. Because of the `ACCESSIBLE BY` clause in the helper package specification, only the API package can access the helper package.

Example 10-7 Separating Cursor Declaration and Definition in Package

```
CREATE PACKAGE emp_stuff AS
  CURSOR c1 RETURN employees%ROWTYPE; -- Declare cursor
END emp_stuff;
/
CREATE PACKAGE BODY emp_stuff AS
  CURSOR c1 RETURN employees%ROWTYPE IS
    SELECT * FROM employees WHERE salary > 2500; -- Define cursor
END emp_stuff;
/
```

Example 10-8 ACCESSIBLE BY Clause

```
CREATE OR REPLACE PACKAGE helper
  AUTHID DEFINER
  ACCESSIBLE BY (api)
IS
  PROCEDURE h1;
  PROCEDURE h2;
END;
/

CREATE OR REPLACE PACKAGE BODY helper
IS
  PROCEDURE h1 IS
  BEGIN
    DBMS_OUTPUT.PUT_LINE('Helper procedure h1');
  END;

  PROCEDURE h2 IS
  BEGIN
    DBMS_OUTPUT.PUT_LINE('Helper procedure h2');
  END;
END;
/

CREATE OR REPLACE PACKAGE api
  AUTHID DEFINER
IS
  PROCEDURE p1;
  PROCEDURE p2;
END;
/

CREATE OR REPLACE PACKAGE BODY api
IS
  PROCEDURE p1 IS
  BEGIN
    DBMS_OUTPUT.PUT_LINE('API procedure p1');
    helper.h1;
  END;
```



```
PROCEDURE p2 IS
BEGIN
    DBMS_OUTPUT.PUT_LINE('API procedure p2');
    helper.h2;
END;
END;
/
```

Invoke procedures in API package:

```
BEGIN
    api.p1;
    api.p2;
END;
/
```

Result:

```
API procedure p1
Helper procedure h1
API procedure p2
Helper procedure h2
```

Invoke a procedure in helper package:

```
BEGIN
    helper.h1;
END;
/
```

Result:

```
SQL> BEGIN
  2   helper.h1;
  3 END;
  4 /
  helper.h1;
  *
ERROR at line 2:
ORA-06550: line 2, column 3:
PLS-00904: insufficient privilege to access object HELPER
ORA-06550: line 2, column 3:
PL/SQL: Statement ignored
```

10.9 Package Example

Example 10-9 creates a table, log, and a package, `emp_admin`, and then invokes package subprograms from an anonymous block. The package has both specification and body.

The specification declares a public type, cursor, and exception, and three public subprograms. One public subprogram is overloaded (for information about overloaded subprograms, see "[Overloaded Subprograms](#)").

The body declares a private variable, defines the public cursor and subprograms that the specification declares, declares and defines a private function, and has an initialization part.

The initialization part (which runs only the first time the anonymous block references the package) inserts one row into the table `log` and initializes the private variable `number_hired` to zero. Every time the package procedure `hire_employee` is invoked, it updates the private variable `number_hired`.

Example 10-9 Creating `emp_admin` Package

```
-- Log to track changes (not part of package):

DROP TABLE log;
CREATE TABLE log (
  date_of_action DATE,
  user_id        VARCHAR2(20),
  package_name   VARCHAR2(30)
);

-- Package specification:

CREATE OR REPLACE PACKAGE emp_admin AUTHID DEFINER AS
  -- Declare public type, cursor, and exception:
  TYPE EmpRecTyp IS RECORD (emp_id NUMBER, sal NUMBER);
  CURSOR desc_salary RETURN EmpRecTyp;
  invalid_salary EXCEPTION;

  -- Declare public subprograms:

  FUNCTION hire_employee (
    last_name        VARCHAR2,
    first_name       VARCHAR2,
    email            VARCHAR2,
    phone_number     VARCHAR2,
    job_id           VARCHAR2,
    salary           NUMBER,
    commission_pct   NUMBER,
    manager_id       NUMBER,
    department_id    NUMBER
  ) RETURN NUMBER;

  -- Overload preceding public subprogram:
  PROCEDURE fire_employee (emp_id NUMBER);
  PROCEDURE fire_employee (emp_email VARCHAR2);

  PROCEDURE raise_salary (emp_id NUMBER, amount NUMBER);
  FUNCTION nth_highest_salary (n NUMBER) RETURN EmpRecTyp;
END emp_admin;
/

-- Package body:

CREATE OR REPLACE PACKAGE BODY emp_admin AS
  number_hired NUMBER; -- private variable, visible only in this package

  -- Define cursor declared in package specification:

  CURSOR desc_salary RETURN EmpRecTyp IS
    SELECT employee_id, salary
    FROM employees
    ORDER BY salary DESC;
```

-- Define subprograms declared in package specification:

```
FUNCTION hire_employee (
  last_name      VARCHAR2,
  first_name     VARCHAR2,
  email          VARCHAR2,
  phone_number   VARCHAR2,
  job_id         VARCHAR2,
  salary         NUMBER,
  commission_pct NUMBER,
  manager_id     NUMBER,
  department_id  NUMBER
) RETURN NUMBER
IS
  new_emp_id NUMBER;
BEGIN
  new_emp_id := employees_seq.NEXTVAL;
  INSERT INTO employees (
    employee_id,
    last_name,
    first_name,
    email,
    phone_number,
    hire_date,
    job_id,
    salary,
    commission_pct,
    manager_id,
    department_id
  )
  VALUES (
    new_emp_id,
    hire_employee.last_name,
    hire_employee.first_name,
    hire_employee.email,
    hire_employee.phone_number,
    SYSDATE,
    hire_employee.job_id,
    hire_employee.salary,
    hire_employee.commission_pct,
    hire_employee.manager_id,
    hire_employee.department_id
  );
  number_hired := number_hired + 1;
  DBMS_OUTPUT.PUT_LINE('The number of employees hired is '
    || TO_CHAR(number_hired) );
  RETURN new_emp_id;
END hire_employee;

PROCEDURE fire_employee (emp_id NUMBER) IS
BEGIN
  DELETE FROM employees WHERE employee_id = emp_id;
END fire_employee;

PROCEDURE fire_employee (emp_email VARCHAR2) IS
BEGIN
  DELETE FROM employees WHERE email = emp_email;
END fire_employee;
```

-- Define private function, available only inside package:

```
FUNCTION sal_ok (
    jobid VARCHAR2,
    sal NUMBER
) RETURN BOOLEAN
IS
    min_sal NUMBER;
    max_sal NUMBER;
BEGIN
    SELECT MIN(salary), MAX(salary)
    INTO min_sal, max_sal
    FROM employees
    WHERE job_id = jobid;

    RETURN (sal >= min_sal) AND (sal <= max_sal);
END sal_ok;

PROCEDURE raise_salary (
    emp_id NUMBER,
    amount NUMBER
)
IS
    sal NUMBER(8,2);
    jobid VARCHAR2(10);
BEGIN
    SELECT job_id, salary INTO jobid, sal
    FROM employees
    WHERE employee_id = emp_id;

    IF sal_ok(jobid, sal + amount) THEN -- Invoke private function
        UPDATE employees
        SET salary = salary + amount
        WHERE employee_id = emp_id;
    ELSE
        RAISE invalid_salary;
    END IF;
EXCEPTION
    WHEN invalid_salary THEN
        DBMS_OUTPUT.PUT_LINE ('The salary is out of the specified range.');
```

```
END raise_salary;

FUNCTION nth_highest_salary (
    n NUMBER
) RETURN EmpRecTyp
IS
    emp_rec EmpRecTyp;
BEGIN
    OPEN desc_salary;
    FOR i IN 1..n LOOP
        FETCH desc_salary INTO emp_rec;
    END LOOP;
    CLOSE desc_salary;
    RETURN emp_rec;
END nth_highest_salary;

BEGIN -- initialization part of package body
    INSERT INTO log (date_of_action, user_id, package_name)
    VALUES (SYSDATE, USER, 'EMP_ADMIN');
    number_hired := 0;
END emp_admin;
/
-- Invoke packages subprograms in anonymous block:
```

```

DECLARE
  new_emp_id NUMBER(6);
BEGIN
  new_emp_id := emp_admin.hire_employee (
    'Belden',
    'Enrique',
    'EBELDEN',
    '555.111.2222',
    'ST_CLERK',
    2500,
    .1,
    101,
    110
  );
  DBMS_OUTPUT.PUT_LINE ('The employee id is ' || TO_CHAR(new_emp_id));
  emp_admin.raise_salary (new_emp_id, 100);

  DBMS_OUTPUT.PUT_LINE (
    'The 10th highest salary is ' ||
    TO_CHAR (emp_admin.nth_highest_salary(10).sal) ||
    ', belonging to employee: ' ||
    TO_CHAR (emp_admin.nth_highest_salary(10).emp_id)
  );

  emp_admin.fire_employee(new_emp_id);
  -- You can also delete the newly added employee as follows:
  -- emp_admin.fire_employee('EBELDEN');
END;
/

```

Result is similar to:

```

The number of employees hired is 1
The employee id is 210
The 10th highest salary is 11500, belonging to employee: 168

```

10.10 How STANDARD Package Defines the PL/SQL Environment

A package named `STANDARD` defines the PL/SQL environment. The package specification declares public types, variables, exceptions, subprograms, which are available automatically to PL/SQL programs. For example, package `STANDARD` declares function `ABS`, which returns the absolute value of its argument, as follows:

```
FUNCTION ABS (n NUMBER) RETURN NUMBER;
```

The contents of package `STANDARD` are directly visible to applications. You need not qualify references to its contents by prefixing the package name. For example, you might invoke `ABS` from a database trigger, stored subprogram, Oracle tool, or 3GL application, as follows:

```
abs_diff := ABS(x - y);
```

If you declare your own version of `ABS`, your local declaration overrides the public declaration. You can still invoke the SQL function by specifying its full name:

```
abs_diff := STANDARD.ABS(x - y);
```

Most SQL functions are overloaded. For example, package `STANDARD` contains these declarations:

```
FUNCTION TO_CHAR (right DATE) RETURN VARCHAR2;  
FUNCTION TO_CHAR (left NUMBER) RETURN VARCHAR2;  
FUNCTION TO_CHAR (left DATE, right VARCHAR2) RETURN VARCHAR2;  
FUNCTION TO_CHAR (left NUMBER, right VARCHAR2) RETURN VARCHAR2;
```

PL/SQL resolves an invocation of `TO_CHAR` by matching the number and data types of the formal and actual parameters.

11

PL/SQL Error Handling

This chapter explains how to handle PL/SQL compile-time warnings and PL/SQL runtime errors. The latter are called **exceptions**.

Note:

The language of warning and error messages depends on the `NLS_LANGUAGE` parameter. For information about this parameter, see *Oracle Database Globalization Support Guide*.

Topics

- [Compile-Time Warnings](#)
- [Overview of Exception Handling](#)
- [Internally Defined Exceptions](#)
- [Predefined Exceptions](#)
- [User-Defined Exceptions](#)
- [Redeclared Predefined Exceptions](#)
- [Raising Exceptions Explicitly](#)
- [Exception Propagation](#)
- [Unhandled Exceptions](#)
- [Retrieving Error Code and Error Message](#)
- [Continuing Execution After Handling Exceptions](#)
- [Retrying Transactions After Handling Exceptions](#)
- [Handling Errors in Distributed Queries](#)

See Also:

- ["Exception Handling in Triggers"](#)
- ["Handling FORALL Exceptions After FORALL Statement Completes"](#)

 **Tip:**

If you have problems creating or running PL/SQL code, check the Oracle Database trace files. The `DIAGNOSTIC_DEST` initialization parameter specifies the current location of the trace files. You can find the value of this parameter by issuing `SHOW PARAMETER DIAGNOSTIC_DEST` or query the `V$DIAG_INFO` view. For more information about diagnostic data, see *Oracle Database Administrator's Guide*.

11.1 Compile-Time Warnings

While compiling stored PL/SQL units, the PL/SQL compiler generates warnings for conditions that are not serious enough to cause errors and prevent compilation—for example, using a deprecated PL/SQL feature.

To see warnings (and errors) generated during compilation, either query the static data dictionary view `*_ERRORS` or, in the SQL*Plus environment, use the command `SHOW ERRORS`.

The message code of a PL/SQL warning has the form `PLW-nnnnn`.

Table 11-1 Compile-Time Warning Categories

Category	Description	Example
SEVERE	Condition might cause unexpected action or wrong results.	Aliasing problems with parameters
PERFORMANCE	Condition might cause performance problems.	Passing a <code>VARCHAR2</code> value to a <code>NUMBER</code> column in an <code>INSERT</code> statement
INFORMATIONAL	Condition does not affect performance or correctness, but you might want to change it to make the code more maintainable.	Code that can never run

By setting the compilation parameter `PLSQL_WARNINGS`, you can:

- Enable and disable all warnings, one or more categories of warnings, or specific warnings
- Treat specific warnings as errors (so that those conditions must be corrected before you can compile the PL/SQL unit)

You can set the value of `PLSQL_WARNINGS` for:

- Your Oracle database instance
Use the `ALTER SYSTEM` statement, described in *Oracle Database SQL Language Reference*.
- Your session
Use the `ALTER SESSION` statement, described in *Oracle Database SQL Language Reference*.

- A stored PL/SQL unit
Use an `ALTER` statement from "[ALTER Statements](#)" with its `compiler_parameters_clause`.

In any of the preceding `ALTER` statements, you set the value of `PLSQL_WARNINGS` with this syntax:

```
PLSQL_WARNINGS = 'value_clause' [, 'value_clause' ] ...
```

For the syntax of `value_clause`, see *Oracle Database Reference*.

To display the current value of `PLSQL_WARNINGS`, query the static data dictionary view `ALL_PLSQL_OBJECT_SETTINGS`.

See Also:

- *Oracle Database Reference* for more information about the static data dictionary view `ALL_PLSQL_OBJECT_SETTINGS`
- *Oracle Database Error Messages Reference* for the message codes of all PL/SQL warnings
- *Oracle Database Reference* for more information about the static data dictionary view `*_ERRORS`
- "[PL/SQL Units and Compilation Parameters](#)" for more information about PL/SQL units and compiler parameters

Example 11-1 Setting Value of `PLSQL_WARNINGS` Compilation Parameter

This example shows several `ALTER` statements that set the value of `PLSQL_WARNINGS`.

For the session, enable all warnings—highly recommended during development:

```
ALTER SESSION SET PLSQL_WARNINGS='ENABLE:ALL';
```

For the session, enable `PERFORMANCE` warnings:

```
ALTER SESSION SET PLSQL_WARNINGS='ENABLE:PERFORMANCE';
```

For the procedure `loc_var`, enable `PERFORMANCE` warnings, and reuse settings:

```
ALTER PROCEDURE loc_var  
  COMPILER PLSQL_WARNINGS='ENABLE:PERFORMANCE'  
  REUSE SETTINGS;
```

For the session, enable `SEVERE` warnings, disable `PERFORMANCE` warnings, and treat `PLW-06002` warnings as errors:

```
ALTER SESSION  
  SET PLSQL_WARNINGS='ENABLE:SEVERE', 'DISABLE:PERFORMANCE', 'ERROR:06002';
```

For the session, disable all warnings:

```
ALTER SESSION SET PLSQL_WARNINGS='DISABLE:ALL';
```

11.1.1 DBMS_WARNING Package

If you are writing PL/SQL units in a development environment that compiles them (such as SQL*Plus), you can display and set the value of `PLSQL_WARNINGS` by invoking subprograms in the `DBMS_WARNING` package.

Example 11-2 uses an `ALTER SESSION` statement to disable all warning messages for the session and then compiles a procedure that has unreachable code. The procedure compiles without warnings. Next, the example enables all warnings for the session by invoking `DBMS_WARNING.set_warning_setting_string` and displays the value of `PLSQL_WARNINGS` by invoking `DBMS_WARNING.get_warning_setting_string`. Finally, the example recompiles the procedure, and the compiler generates a warning about the unreachable code.

 **Note:**

Unreachable code could represent a mistake or be intentionally hidden by a debug flag.

`DBMS_WARNING` subprograms are useful when you are compiling a complex application composed of several nested SQL*Plus scripts, where different subprograms need different `PLSQL_WARNINGS` settings. With `DBMS_WARNING` subprograms, you can save the current `PLSQL_WARNINGS` setting, change the setting to compile a particular set of subprograms, and then restore the setting to its original value.

 **See Also:**

Oracle Database PL/SQL Packages and Types Reference for more information about the `DBMS_WARNING` package

Example 11-2 Displaying and Setting `PLSQL_WARNINGS` with `DBMS_WARNING` Subprograms

Disable all warning messages for this session:

```
ALTER SESSION SET PLSQL_WARNINGS='DISABLE:ALL';
```

With warnings disabled, this procedure compiles with no warnings:

```
CREATE OR REPLACE PROCEDURE unreachable_code AUTHID DEFINER AS
  x CONSTANT BOOLEAN := TRUE;
BEGIN
  IF x THEN
    DBMS_OUTPUT.PUT_LINE('TRUE');
  ELSE
    DBMS_OUTPUT.PUT_LINE('FALSE');
  END IF;
END unreachable_code;
/
```

Enable all warning messages for this session:

```
CALL DBMS_WARNING.set_warning_setting_string ('ENABLE:ALL', 'SESSION');
```

Check warning setting:

```
SELECT DBMS_WARNING.get_warning_setting_string() FROM DUAL;
```

Result:

```
DBMS_WARNING.GET_WARNING_SETTING_STRING()  
-----
```

```
ENABLE:ALL
```

```
1 row selected.
```

Recompile procedure:

```
ALTER PROCEDURE unreachable_code COMPILE;
```

Result:

```
SP2-0805: Procedure altered with compilation warnings
```

Show errors:

```
SHOW ERRORS
```

Result:

```
Errors for PROCEDURE UNREACHABLE_CODE:
```

```
LINE/COL ERROR  
-----
```

```
7/5      PLW-06002: Unreachable code
```

11.2 Overview of Exception Handling

Exceptions (PL/SQL runtime errors) can arise from design faults, coding mistakes, hardware failures, and many other sources. You cannot anticipate all possible exceptions, but you can write exception handlers that let your program to continue to operate in their presence.

Any PL/SQL block can have an exception-handling part, which can have one or more exception handlers. For example, an exception-handling part could have this syntax:

```
EXCEPTION  
  WHEN ex_name_1 THEN statements_1          -- Exception handler  
  WHEN ex_name_2 OR ex_name_3 THEN statements_2 -- Exception handler  
  WHEN OTHERS THEN statements_3            -- Exception handler  
END;
```

In the preceding syntax example, *ex_name_n* is the name of an exception and *statements_n* is one or more statements. (For complete syntax and semantics, see ["Exception Handler"](#).)

When an exception is raised in the executable part of the block, the executable part stops and control transfers to the exception-handling part. If *ex_name_1* was raised, then *statements_1* run. If either *ex_name_2* or *ex_name_3* was raised, then *statements_2* run. If any other exception was raised, then *statements_3* run.

After an exception handler runs, control transfers to the next statement of the enclosing block. If there is no enclosing block, then:

- If the exception handler is in a subprogram, then control returns to the invoker, at the statement after the invocation.
- If the exception handler is in an anonymous block, then control transfers to the host environment (for example, SQL*Plus)

If an exception is raised in a block that has no exception handler for it, then the exception propagates. That is, the exception reproduces itself in successive enclosing blocks until a block has a handler for it or there is no enclosing block (for more information, see "[Exception Propagation](#)"). If there is no handler for the exception, then PL/SQL returns an unhandled exception error to the invoker or host environment, which determines the outcome (for more information, see "[Unhandled Exceptions](#)").

Topics

- [Exception Categories](#)
- [Advantages of Exception Handlers](#)
- [Guidelines for Avoiding and Handling Exceptions](#)

11.2.1 Exception Categories

The exception categories are:

- **Internally defined**

The runtime system raises internally defined exceptions implicitly (automatically). Examples of internally defined exceptions are ORA-00060 (deadlock detected while waiting for resource) and ORA-27102 (out of memory).

An internally defined exception always has an error code, but does not have a name unless PL/SQL gives it one or you give it one.

For more information, see "[Internally Defined Exceptions](#)".

- **Predefined**

A predefined exception is an internally defined exception that PL/SQL has given a name. For example, ORA-06500 (PL/SQL: storage error) has the predefined name `STORAGE_ERROR`.

For more information, see "[Predefined Exceptions](#)".

- **User-defined**

You can declare your own exceptions in the declarative part of any PL/SQL anonymous block, subprogram, or package. For example, you might declare an exception named `insufficient_funds` to flag overdrawn bank accounts.

You must raise user-defined exceptions explicitly.

For more information, see "[User-Defined Exceptions](#)".

[Table 11-2](#) summarizes the exception categories.

Table 11-2 Exception Categories

Category	Definer	Has Error Code	Has Name	Raised Implicitly	Raised Explicitly
Internally defined	Runtime system	Always	Only if you assign one	Yes	Optionally ¹
Predefined	Runtime system	Always	Always	Yes	Optionally ¹
User-defined	User	Only if you assign one	Always	No	Always

¹ For details, see ["Raising Internally Defined Exception with RAISE Statement"](#).

For a named exception, you can write a specific exception handler, instead of handling it with an `OTHERS` exception handler. A specific exception handler is more efficient than an `OTHERS` exception handler, because the latter must invoke a function to determine which exception it is handling. For details, see ["Retrieving Error Code and Error Message"](#).

11.2.2 Advantages of Exception Handlers

Using exception handlers for error-handling makes programs easier to write and understand, and reduces the likelihood of unhandled exceptions.

Without exception handlers, you must check for every possible error, everywhere that it might occur, and then handle it. It is easy to overlook a possible error or a place where it might occur, especially if the error is not immediately detectable (for example, bad data might be undetectable until you use it in a calculation). Error-handling code is scattered throughout the program.

With exception handlers, you need not know every possible error or everywhere that it might occur. You need only include an exception-handling part in each block where errors might occur. In the exception-handling part, you can include exception handlers for both specific and unknown errors. If an error occurs anywhere in the block (including inside a sub-block), then an exception handler handles it. Error-handling code is isolated in the exception-handling parts of the blocks.

In [Example 11-3](#), a procedure uses a single exception handler to handle the predefined exception `NO_DATA_FOUND`, which can occur in either of two `SELECT INTO` statements.

If multiple statements use the same exception handler, and you want to know which statement failed, you can use locator variables, as in [Example 11-4](#).

You determine the precision of your error-handling code. You can have a single exception handler for all division-by-zero errors, bad array indexes, and so on. You can also check for errors in a single statement by putting that statement inside a block with its own exception handler.

Example 11-3 Single Exception Handler for Multiple Exceptions

```

CREATE OR REPLACE PROCEDURE select_item (
  t_column VARCHAR2,
  t_name   VARCHAR2
) AUTHID DEFINER
IS
  temp VARCHAR2(30);
BEGIN
  temp := t_column; -- For error message if next SELECT fails

  -- Fails if table t_name does not have column t_column:

  SELECT COLUMN_NAME INTO temp
  FROM USER_TAB_COLS
  WHERE TABLE_NAME = UPPER(t_name)
  AND COLUMN_NAME = UPPER(t_column);

  temp := t_name; -- For error message if next SELECT fails

  -- Fails if there is no table named t_name:

  SELECT OBJECT_NAME INTO temp
  FROM USER_OBJECTS
  WHERE OBJECT_NAME = UPPER(t_name)
  AND OBJECT_TYPE = 'TABLE';

EXCEPTION
  WHEN NO_DATA_FOUND THEN
    DBMS_OUTPUT.PUT_LINE ('No Data found for SELECT on ' || temp);
  WHEN OTHERS THEN
    DBMS_OUTPUT.PUT_LINE ('Unexpected error');
    RAISE;
END;
/

```

Invoke procedure (there is a DEPARTMENTS table, but it does not have a LAST_NAME column):

```

BEGIN
  select_item('departments', 'last_name');
END;
/

```

Result:

No Data found for SELECT on departments

Invoke procedure (there is no EMP table):

```

BEGIN
  select_item('emp', 'last_name');
END;
/

```

Result:

No Data found for SELECT on emp

Example 11-4 Locator Variables for Statements that Share Exception Handler

```
CREATE OR REPLACE PROCEDURE loc_var AUTHID DEFINER IS
  stmt_no  POSITIVE;
  name_    VARCHAR2(100);
BEGIN
  stmt_no := 1;

  SELECT table_name INTO name_
  FROM user_tables
  WHERE table_name LIKE 'ABC%';

  stmt_no := 2;

  SELECT table_name INTO name_
  FROM user_tables
  WHERE table_name LIKE 'XYZ%';
EXCEPTION
  WHEN NO_DATA_FOUND THEN
    DBMS_OUTPUT.PUT_LINE ('Table name not found in query ' || stmt_no);
END;
/
CALL loc_var();
```

Result:

Table name not found in query 1

11.2.3 Guidelines for Avoiding and Handling Exceptions

To make your programs as reliable and safe as possible:

- Use both error-checking code and exception handlers.

Use error-checking code wherever bad input data can cause an error. Examples of bad input data are incorrect or null actual parameters and queries that return no rows or more rows than you expect. Test your code with different combinations of bad input data to see what potential errors arise.

Sometimes you can use error-checking code to avoid raising an exception, as in [Example 11-7](#).

- Add exception handlers wherever errors can occur.

Errors are especially likely during arithmetic calculations, string manipulation, and database operations. Errors can also arise from problems that are independent of your code—for example, disk storage or memory hardware failure—but your code still must take corrective action.

- Design your programs to work when the database is not in the state you expect.

For example, a table you query might have columns added or deleted, or their types might have changed. You can avoid problems by declaring scalar variables with %TYPE qualifiers and record variables to hold query results with %ROWTYPE qualifiers.

- Whenever possible, write exception handlers for named exceptions instead of using OTHERS exception handlers.

Learn the names and causes of the predefined exceptions. If you know that your database operations might raise specific internally defined exceptions that do not have names, then give them names so that you can write exception handlers specifically for them.

- Have your exception handlers output debugging information.
If you store the debugging information in a separate table, do it with an autonomous routine, so that you can commit your debugging information even if you roll back the work that the main subprogram did. For information about autonomous routines, see "[AUTONOMOUS_TRANSACTION Pragma](#)".
- For each exception handler, carefully decide whether to have it commit the transaction, roll it back, or let it continue.
Regardless of the severity of the error, you want to leave the database in a consistent state and avoid storing bad data.
- Avoid unhandled exceptions by including an `OTHERS` exception handler at the top level of every PL/SQL program.
Make the last statement in the `OTHERS` exception handler either `RAISE` or an invocation of the `RAISE_APPLICATION_ERROR` procedure. (If you do not follow this practice, and PL/SQL warnings are enabled, then you get PLW-06009.) For information about `RAISE` or an invocation of the `RAISE_APPLICATION_ERROR`, see "[Raising Exceptions Explicitly](#)".

11.3 Internally Defined Exceptions

Internally defined exceptions (ORA-*n* errors) are described in *Oracle Database Error Messages Reference*. The runtime system raises them implicitly (automatically).

An internally defined exception does not have a name unless either PL/SQL gives it one (see "[Predefined Exceptions](#)") or you give it one.

If you know that your database operations might raise specific internally defined exceptions that do not have names, then give them names so that you can write exception handlers specifically for them. Otherwise, you can handle them only with `OTHERS` exception handlers.

To give a name to an internally defined exception, do the following in the declarative part of the appropriate anonymous block, subprogram, or package. (To determine the appropriate block, see "[Exception Propagation](#)".)

1. Declare the name.

An exception name declaration has this syntax:

```
exception_name EXCEPTION;
```

For semantic information, see "[Exception Declaration](#)".

2. Associate the name with the error code of the internally defined exception.

The syntax is:

```
PRAGMA EXCEPTION_INIT (exception_name, error_code)
```

For semantic information, see "[EXCEPTION_INIT Pragma](#)".

 **Note:**

An internally defined exception with a user-declared name is still an internally defined exception, not a user-defined exception.

[Example 11-5](#) gives the name `deadlock_detected` to the internally defined exception `ORA-00060` (deadlock detected while waiting for resource) and uses the name in an exception handler.

 **See Also:**

["Raising Internally Defined Exception with RAISE Statement"](#)

Example 11-5 Naming Internally Defined Exception

```
DECLARE
    deadlock_detected EXCEPTION;
    PRAGMA EXCEPTION_INIT(deadlock_detected, -60);
BEGIN
    ...
EXCEPTION
    WHEN deadlock_detected THEN
    ...
END;
/
```

11.4 Predefined Exceptions

Predefined exceptions are internally defined exceptions that have predefined names, which PL/SQL declares globally in the package `STANDARD`. The runtime system raises predefined exceptions implicitly (automatically). Because predefined exceptions have names, you can write exception handlers specifically for them.

[Table 11-3](#) lists the names and error codes of the predefined exceptions.

Table 11-3 PL/SQL Predefined Exceptions

Exception Name	Error Code
<code>ACCESS_INTO_NULL</code>	-6530
<code>CASE_NOT_FOUND</code>	-6592
<code>COLLECTION_IS_NULL</code>	-6531
<code>CURSOR_ALREADY_OPEN</code>	-6511
<code>DUP_VAL_ON_INDEX</code>	-1
<code>INVALID_CURSOR</code>	-1001
<code>INVALID_NUMBER</code>	-1722
<code>LOGIN_DENIED</code>	-1017

Table 11-3 (Cont.) PL/SQL Predefined Exceptions

Exception Name	Error Code
NO_DATA_FOUND	+100
NO_DATA_NEEDED	-6548
NOT_LOGGED_ON	-1012
PROGRAM_ERROR	-6501
ROWTYPE_MISMATCH	-6504
SELF_IS_NULL	-30625
STORAGE_ERROR	-6500
SUBSCRIPT_BEYOND_COUNT	-6533
SUBSCRIPT_OUTSIDE_LIMIT	-6532
SYS_INVALID_ROWID	-1410
TIMEOUT_ON_RESOURCE	-51
TOO_MANY_ROWS	-1422
VALUE_ERROR	-6502
ZERO_DIVIDE	-1476

[Example 11-6](#) calculates a price-to-earnings ratio for a company. If the company has zero earnings, the division operation raises the predefined exception `ZERO_DIVIDE` and the executable part of the block transfers control to the exception-handling part.

[Example 11-7](#) uses error-checking code to avoid the exception that [Example 11-6](#) handles.

In [Example 11-8](#), the procedure opens a cursor variable for either the `EMPLOYEES` table or the `DEPARTMENTS` table, depending on the value of the parameter `discrim`. The anonymous block invokes the procedure to open the cursor variable for the `EMPLOYEES` table, but fetches from the `DEPARTMENTS` table, which raises the predefined exception `ROWTYPE_MISMATCH`.



See Also:

["Raising Internally Defined Exception with RAISE Statement"](#)

Example 11-6 Anonymous Block Handles ZERO_DIVIDE

```

DECLARE
  stock_price  NUMBER := 9.73;
  net_earnings NUMBER := 0;
  pe_ratio     NUMBER;
BEGIN
  pe_ratio := stock_price / net_earnings; -- raises ZERO_DIVIDE exception
  DBMS_OUTPUT.PUT_LINE('Price/earnings ratio = ' || pe_ratio);
EXCEPTION
  WHEN ZERO_DIVIDE THEN
    DBMS_OUTPUT.PUT_LINE('Company had zero earnings.');
```

```

    pe_ratio := NULL;
END;
/

```

Result:

Company had zero earnings.

Example 11-7 Anonymous Block Avoids ZERO_DIVIDE

```

DECLARE
    stock_price  NUMBER := 9.73;
    net_earnings NUMBER := 0;
    pe_ratio     NUMBER;
BEGIN
    pe_ratio :=
        CASE net_earnings
            WHEN 0 THEN NULL
            ELSE stock_price / net_earnings
        END;
END;
/

```

Example 11-8 Anonymous Block Handles ROWTYPE_MISMATCH

```

CREATE OR REPLACE PACKAGE emp_dept_data AUTHID DEFINER AS
    TYPE cv_type IS REF CURSOR;

    PROCEDURE open_cv (
        cv          IN OUT cv_type,
        discrim    IN      POSITIVE
    );
END emp_dept_data;
/

CREATE OR REPLACE PACKAGE BODY emp_dept_data AS
    PROCEDURE open_cv (
        cv          IN OUT cv_type,
        discrim    IN      POSITIVE) IS
    BEGIN
        IF discrim = 1 THEN
            OPEN cv FOR
                SELECT * FROM EMPLOYEES ORDER BY employee_id;
        ELSIF discrim = 2 THEN
            OPEN cv FOR
                SELECT * FROM DEPARTMENTS ORDER BY department_id;
        END IF;
    END open_cv;
END emp_dept_data;
/

```

Invoke procedure `open_cv` from anonymous block:

```

DECLARE
    emp_rec  EMPLOYEES%ROWTYPE;
    dept_rec DEPARTMENTS%ROWTYPE;
    cv       Emp_dept_data.CV_TYPE;
BEGIN
    emp_dept_data.open_cv(cv, 1); -- Open cv for EMPLOYEES fetch.
    FETCH cv INTO dept_rec;      -- Fetch from DEPARTMENTS.
    DBMS_OUTPUT.PUT(dept_rec.DEPARTMENT_ID);
    DBMS_OUTPUT.PUT_LINE(' ' || dept_rec.LOCATION_ID);

```

```

EXCEPTION
  WHEN ROWTYPE_MISMATCH THEN
  BEGIN
    DBMS_OUTPUT.PUT_LINE
      ('Row type mismatch, fetching EMPLOYEES data ...');
    FETCH cv INTO emp_rec;
    DBMS_OUTPUT.PUT(emp_rec.DEPARTMENT_ID);
    DBMS_OUTPUT.PUT_LINE(' ' || emp_rec.LAST_NAME);
  END;
END;
/

```

Result:

```

Row type mismatch, fetching EMPLOYEES data ...
90 King

```

11.5 User-Defined Exceptions

You can declare your own exceptions in the declarative part of any PL/SQL anonymous block, subprogram, or package.

An exception name declaration has this syntax:

```
exception_name EXCEPTION;
```

For semantic information, see "[Exception Declaration](#)".

You must raise a user-defined exception explicitly. For details, see "[Raising Exceptions Explicitly](#)".

11.6 Redeclared Predefined Exceptions

Oracle recommends against redeclaring predefined exceptions—that is, declaring a user-defined exception name that is a predefined exception name. (For a list of predefined exception names, see [Table 11-3](#).)

If you redeclare a predefined exception, your local declaration overrides the global declaration in package `STANDARD`. Exception handlers written for the globally declared exception become unable to handle it—unless you qualify its name with the package name `STANDARD`.

[Example 11-9](#) shows this.

Example 11-9 Redeclared Predefined Identifier

```

DROP TABLE t;
CREATE TABLE t (c NUMBER);

```

In the following block, the `INSERT` statement implicitly raises the predefined exception `INVALID_NUMBER`, which the exception handler handles.

```

DECLARE
  default_number NUMBER := 0;
BEGIN
  INSERT INTO t VALUES(TO_NUMBER('100.00', '9G999'));
EXCEPTION
  WHEN INVALID_NUMBER THEN

```

```

        DBMS_OUTPUT.PUT_LINE('Substituting default value for invalid number.');
```

```

        INSERT INTO t VALUES(default_number);
END;
/
```

Result:

```
Substituting default value for invalid number.
```

The following block redeclares the predefined exception `INVALID_NUMBER`. When the `INSERT` statement implicitly raises the predefined exception `INVALID_NUMBER`, the exception handler does not handle it.

```

DECLARE
    default_number NUMBER := 0;
    i NUMBER := 5;
    invalid_number EXCEPTION;    -- redeclare predefined exception
BEGIN
    INSERT INTO t VALUES(TO_NUMBER('100.00', '9G999'));
EXCEPTION
    WHEN INVALID_NUMBER THEN
        DBMS_OUTPUT.PUT_LINE('Substituting default value for invalid number.');
```

```

        INSERT INTO t VALUES(default_number);
END;
/
```

Result:

```

DECLARE
*
ERROR at line 1:
ORA-01722: invalid number
ORA-06512: at line 6
```

The exception handler in the preceding block handles the predefined exception `INVALID_NUMBER` if you qualify the exception name in the exception handler:

```

DECLARE
    default_number NUMBER := 0;
    i NUMBER := 5;
    invalid_number EXCEPTION;    -- redeclare predefined exception
BEGIN
    INSERT INTO t VALUES(TO_NUMBER('100.00', '9G999'));
EXCEPTION
    WHEN STANDARD.INVALID_NUMBER THEN
        DBMS_OUTPUT.PUT_LINE('Substituting default value for invalid number.');
```

```

        INSERT INTO t VALUES(default_number);
END;
/
```

Result:

```
Substituting default value for invalid number.
```

11.7 Raising Exceptions Explicitly

To raise an exception explicitly, use either the `RAISE` statement or `RAISE_APPLICATION_ERROR` procedure.

Topics

- [RAISE Statement](#)
- [RAISE_APPLICATION_ERROR Procedure](#)

11.7.1 RAISE Statement

The `RAISE` statement explicitly raises an exception. Outside an exception handler, you must specify the exception name. Inside an exception handler, if you omit the exception name, the `RAISE` statement reraises the current exception.

Topics

- [Raising User-Defined Exception with RAISE Statement](#)
- [Raising Internally Defined Exception with RAISE Statement](#)
- [Reraising Current Exception with RAISE Statement](#)

11.7.1.1 Raising User-Defined Exception with RAISE Statement

In [Example 11-10](#), the procedure declares an exception named `past_due`, raises it explicitly with the `RAISE` statement, and handles it with an exception handler.

Example 11-10 Declaring, Raising, and Handling User-Defined Exception

```
CREATE PROCEDURE account_status (  
    due_date DATE,  
    today    DATE  
) AUTHID DEFINER  
IS  
    past_due EXCEPTION; -- declare exception  
BEGIN  
    IF due_date < today THEN  
        RAISE past_due; -- explicitly raise exception  
    END IF;  
EXCEPTION  
    WHEN past_due THEN -- handle exception  
        DBMS_OUTPUT.PUT_LINE ('Account past due.');
```

```
END;  
/  
  
BEGIN  
    account_status (TO_DATE('01-JUL-2010', 'DD-MON-YYYY'),  
                   TO_DATE('09-JUL-2010', 'DD-MON-YYYY'));
```

```
END;  
/
```

Result:

```
Account past due.
```

11.7.1.2 Raising Internally Defined Exception with RAISE Statement

Although the runtime system raises internally defined exceptions implicitly, you can raise them explicitly with the `RAISE` statement if they have names. [Table 11-3](#) lists the internally defined exceptions that have predefined names. "[Internally Defined Exceptions](#)" explains how to give user-declared names to internally defined exceptions.

An exception handler for a named internally defined exception handles that exception whether it is raised implicitly or explicitly.

In [Example 11-11](#), the procedure raises the predefined exception `INVALID_NUMBER` either explicitly or implicitly, and the `INVALID_NUMBER` exception handler always handles it.

Example 11-11 Explicitly Raising Predefined Exception

```
DROP TABLE t;
CREATE TABLE t (c NUMBER);

CREATE PROCEDURE p (n NUMBER) AUTHID DEFINER IS
  default_number NUMBER := 0;
BEGIN
  IF n < 0 THEN
    RAISE INVALID_NUMBER; -- raise explicitly
  ELSE
    INSERT INTO t VALUES(TO_NUMBER('100.00', '9G999')); -- raise implicitly
  END IF;
EXCEPTION
  WHEN INVALID_NUMBER THEN
    DBMS_OUTPUT.PUT_LINE('Substituting default value for invalid number.');
```

```
    INSERT INTO t VALUES(default_number);
END;
/

BEGIN
  p(-1);
END;
/
```

Result:

```
Substituting default value for invalid number.
```

```
BEGIN
  p(1);
END;
/
```

Result:

```
Substituting default value for invalid number.
```

11.7.1.3 Reraising Current Exception with RAISE Statement

In an exception handler, you can use the `RAISE` statement to "reraise" the exception being handled. Reraising the exception passes it to the enclosing block, which can handle it further. (If the enclosing block cannot handle the reraised exception, then the exception propagates—

see ["Exception Propagation"](#).) When reraising the current exception, you need not specify an exception name.

In [Example 11-12](#), the handling of the exception starts in the inner block and finishes in the outer block. The outer block declares the exception, so the exception name exists in both blocks, and each block has an exception handler specifically for that exception. The inner block raises the exception, and its exception handler does the initial handling and then reraises the exception, passing it to the outer block for further handling.

Example 11-12 Reraising Exception

```

DECLARE
    salary_too_high    EXCEPTION;
    current_salary     NUMBER := 20000;
    max_salary         NUMBER := 10000;
    erroneous_salary   NUMBER;
BEGIN

    BEGIN
        IF current_salary > max_salary THEN
            RAISE salary_too_high;    -- raise exception
        END IF;
    EXCEPTION
        WHEN salary_too_high THEN    -- start handling exception
            erroneous_salary := current_salary;
            DBMS_OUTPUT.PUT_LINE('Salary ' || erroneous_salary || ' is out of range. ');
            DBMS_OUTPUT.PUT_LINE ('Maximum salary is ' || max_salary || '. ');
            RAISE;    -- reraise current exception (exception name is optional)
        END;

    EXCEPTION
        WHEN salary_too_high THEN    -- finish handling exception
            current_salary := max_salary;

            DBMS_OUTPUT.PUT_LINE (
                'Revising salary from ' || erroneous_salary ||
                ' to ' || current_salary || '.'
            );
    END;
/

```

Result:

```

Salary 20000 is out of range.
Maximum salary is 10000.
Revising salary from 20000 to 10000.

```

11.7.2 RAISE_APPLICATION_ERROR Procedure

You can invoke the `RAISE_APPLICATION_ERROR` procedure (defined in the `DBMS_STANDARD` package) only from a stored subprogram or method. Typically, you invoke this procedure to raise a user-defined exception and return its error code and error message to the invoker.

To invoke `RAISE_APPLICATION_ERROR`, use this syntax:

```
RAISE_APPLICATION_ERROR (error_code, message[, {TRUE | FALSE}]);
```

You must have assigned *error_code* to the user-defined exception with the `EXCEPTION_INIT` pragma. The syntax is:

```
PRAGMA EXCEPTION_INIT (exception_name, error_code)
```

The *error_code* is an integer in the range -20000..-20999 and the *message* is a character string of at most 2048 bytes.

For semantic information, see "[EXCEPTION_INIT Pragma](#)".

The *message* is a character string of at most 2048 bytes.

If you specify `TRUE`, PL/SQL puts *error_code* on top of the error stack. Otherwise, PL/SQL replaces the error stack with *error_code*.

In [Example 11-13](#), an anonymous block declares an exception named `past_due`, assigns the error code -20000 to it, and invokes a stored procedure. The stored procedure invokes the `RAISE_APPLICATION_ERROR` procedure with the error code -20000 and a message, whereupon control returns to the anonymous block, which handles the exception. To retrieve the message associated with the exception, the exception handler in the anonymous block invokes the `SQLERRM` function, described in "[Retrieving Error Code and Error Message](#)".

Example 11-13 Raising User-Defined Exception with `RAISE_APPLICATION_ERROR`

```
CREATE PROCEDURE account_status (
    due_date DATE,
    today    DATE
) AUTHID DEFINER
IS
BEGIN
    IF due_date < today THEN                -- explicitly raise exception
        RAISE_APPLICATION_ERROR(-20000, 'Account past due.');
```

```
    END IF;
END;
/

DECLARE
    past_due EXCEPTION;                    -- declare exception
    PRAGMA EXCEPTION_INIT (past_due, -20000); -- assign error code to exception
BEGIN
    account_status (TO_DATE('01-JUL-2010', 'DD-MON-YYYY'),
                   TO_DATE('09-JUL-2010', 'DD-MON-YYYY')); -- invoke procedure

EXCEPTION
    WHEN past_due THEN                      -- handle exception
        DBMS_OUTPUT.PUT_LINE(TO_CHAR(SQLERRM(-20000)));
END;
/
```

Result:

```
ORA-20000: Account past due.
```

11.8 Exception Propagation

If an exception is raised in a block that has no exception handler for it, then the exception **propagates**. That is, the exception reproduces itself in successive enclosing blocks until either a block has a handler for it or there is no enclosing block. If there is no handler for the exception, then PL/SQL returns an unhandled exception error to the invoker or host

environment, which determines the outcome (for more information, see "Unhandled Exceptions").

In Figure 11-1, one block is nested inside another. The inner block raises exception A. The inner block has an exception handler for A, so A does not propagate. After the exception handler runs, control transfers to the next statement of the outer block.

Figure 11-1 Exception Does Not Propagate

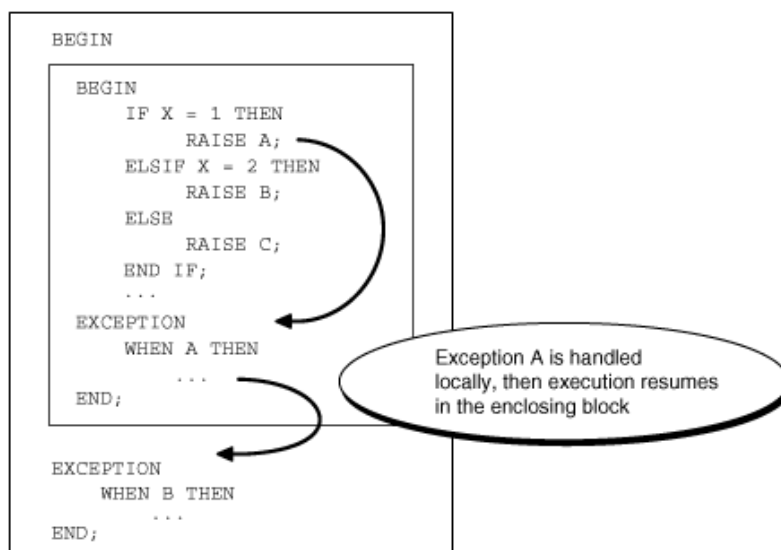

In Figure 11-2, the inner block raises exception B. The inner block does not have an exception handler for exception B, so B propagates to the outer block, which does have an exception handler for it. After the exception handler runs, control transfers to the host environment.

Figure 11-2 Exception Propagates from Inner Block to Outer Block

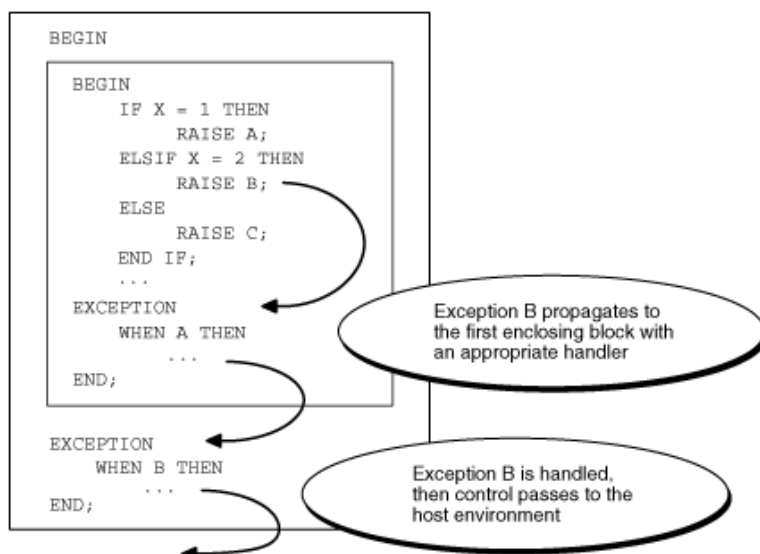

In [Figure 11-3](#), the inner block raises exception C. The inner block does not have an exception handler for C, so exception C propagates to the outer block. The outer block does not have an exception handler for C, so PL/SQL returns an unhandled exception error to the host environment.

Figure 11-3 PL/SQL Returns Unhandled Exception Error to Host Environment

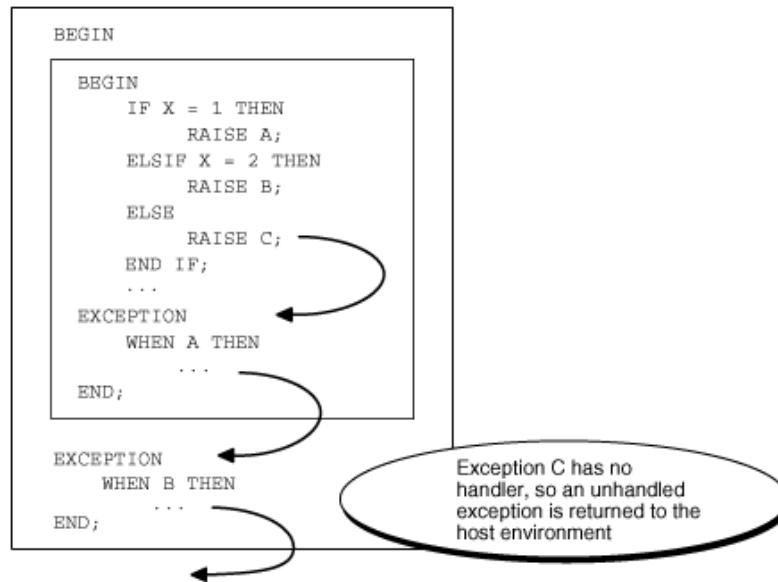

A user-defined exception can propagate beyond its scope (that is, beyond the block that declares it), but its name does not exist beyond its scope. Therefore, beyond its scope, a user-defined exception can be handled only with an `OTHERS` exception handler.

In [Example 11-14](#), the inner block declares an exception named `past_due`, for which it has no exception handler. When the inner block raises `past_due`, the exception propagates to the outer block, where the name `past_due` does not exist. The outer block handles the exception with an `OTHERS` exception handler.

If the outer block does not handle the user-defined exception, then an error occurs, as in [Example 11-15](#).



Note:

Exceptions cannot propagate across remote subprogram invocations. Therefore, a PL/SQL block cannot handle an exception raised by a remote subprogram.

Topics

- [Propagation of Exceptions Raised in Declarations](#)
- [Propagation of Exceptions Raised in Exception Handlers](#)

Example 11-14 Exception that Propagates Beyond Scope is Handled

```

CREATE OR REPLACE PROCEDURE p AUTHID DEFINER AS
BEGIN

```

```

DECLARE
    past_due      EXCEPTION;
    PRAGMA EXCEPTION_INIT (past_due, -4910);
    due_date      DATE := trunc(SYSDATE) - 1;
    todays_date   DATE := trunc(SYSDATE);
BEGIN
    IF due_date < todays_date THEN
        RAISE past_due;
    END IF;
END;

EXCEPTION
    WHEN OTHERS THEN
        ROLLBACK;
        RAISE;
END;
/

```

Example 11-15 Exception that Propagates Beyond Scope is Not Handled

```

BEGIN

    DECLARE
        past_due      EXCEPTION;
        due_date      DATE := trunc(SYSDATE) - 1;
        todays_date   DATE := trunc(SYSDATE);
    BEGIN
        IF due_date < todays_date THEN
            RAISE past_due;
        END IF;
    END;

END;
/

```

Result:

```

BEGIN
*
ERROR at line 1:
ORA-06510: PL/SQL: unhandled user-defined exception
ORA-06512: at line 9

```

11.8.1 Propagation of Exceptions Raised in Declarations

An exception raised in a declaration propagates immediately to the enclosing block (or to the invoker or host environment if there is no enclosing block). Therefore, the exception handler must be in an enclosing or invoking block, not in the same block as the declaration.

In [Example 11-16](#), the `VALUE_ERROR` exception handler is in the same block as the declaration that raises `VALUE_ERROR`. Because the exception propagates immediately to the host environment, the exception handler does not handle it.

[Example 11-17](#) is like [Example 11-16](#) except that an enclosing block handles the `VALUE_ERROR` exception that the declaration in the inner block raises.

Example 11-16 Exception Raised in Declaration is Not Handled

```
DECLARE
  credit_limit CONSTANT NUMBER(3) := 5000;  -- Maximum value is 999
BEGIN
  NULL;
EXCEPTION
  WHEN VALUE_ERROR THEN
    DBMS_OUTPUT.PUT_LINE('Exception raised in declaration.');
```

END;

/

Result:

```
DECLARE
*
ERROR at line 1:
ORA-06502: PL/SQL: numeric or value error: number precision too large
ORA-06512: at line 2
```

Example 11-17 Exception Raised in Declaration is Handled by Enclosing Block

```
BEGIN

  DECLARE
    credit_limit CONSTANT NUMBER(3) := 5000;
  BEGIN
    NULL;
  END;

EXCEPTION
  WHEN VALUE_ERROR THEN
    DBMS_OUTPUT.PUT_LINE('Exception raised in declaration.');
```

END;

/

Result:

Exception raised in declaration.

11.8.2 Propagation of Exceptions Raised in Exception Handlers

An exception raised in an exception handler propagates immediately to the enclosing block (or to the invoker or host environment if there is no enclosing block). Therefore, the exception handler must be in an enclosing or invoking block.

In [Example 11-18](#), when *n* is zero, the calculation $1/n$ raises the predefined exception `ZERO_DIVIDE`, and control transfers to the `ZERO_DIVIDE` exception handler in the same block. When the exception handler raises `ZERO_DIVIDE`, the exception propagates immediately to the invoker. The invoker does not handle the exception, so PL/SQL returns an unhandled exception error to the host environment.

[Example 11-19](#) is like [Example 11-18](#) except that when the procedure returns an unhandled exception error to the invoker, the invoker handles it.

[Example 11-20](#) is like [Example 11-18](#) except that an enclosing block handles the exception that the exception handler in the inner block raises.

In [Example 11-21](#), the exception-handling part of the procedure has exception handlers for user-defined exception `i_is_one` and predefined exception `ZERO_DIVIDE`. When the `i_is_one`

exception handler raises `ZERO_DIVIDE`, the exception propagates immediately to the invoker (therefore, the `ZERO_DIVIDE` exception handler does not handle it). The invoker does not handle the exception, so PL/SQL returns an unhandled exception error to the host environment.

[Example 11-22](#) is like [Example 11-21](#) except that an enclosing block handles the `ZERO_DIVIDE` exception that the `i_is_one` exception handler raises.

Example 11-18 Exception Raised in Exception Handler is Not Handled

```
CREATE PROCEDURE print_reciprocal (n NUMBER) AUTHID DEFINER IS
BEGIN
    DBMS_OUTPUT.PUT_LINE(1/n); -- handled
EXCEPTION
    WHEN ZERO_DIVIDE THEN
        DBMS_OUTPUT.PUT_LINE('Error:');
        DBMS_OUTPUT.PUT_LINE(1/n || ' is undefined'); -- not handled
END;
/

BEGIN -- invoking block
    print_reciprocal(0);
END;
```

Result:

```
Error:
BEGIN
*
ERROR at line 1:
ORA-01476: divisor is equal to zero
ORA-06512: at "HR.PRINT_RECIPROCAL", line 7
ORA-01476: divisor is equal to zero
ORA-06512: at line 2
```

Example 11-19 Exception Raised in Exception Handler is Handled by Invoker

```
CREATE PROCEDURE print_reciprocal (n NUMBER) AUTHID DEFINER IS
BEGIN
    DBMS_OUTPUT.PUT_LINE(1/n);
EXCEPTION
    WHEN ZERO_DIVIDE THEN
        DBMS_OUTPUT.PUT_LINE('Error:');
        DBMS_OUTPUT.PUT_LINE(1/n || ' is undefined');
END;
/

BEGIN -- invoking block
    print_reciprocal(0);
EXCEPTION
    WHEN ZERO_DIVIDE THEN -- handles exception raised in exception handler
        DBMS_OUTPUT.PUT_LINE('1/0 is undefined.');
```

Result:

```
Error:
1/0 is undefined.
```

Example 11-20 Exception Raised in Exception Handler is Handled by Enclosing Block

```

CREATE PROCEDURE print_reciprocal (n NUMBER) AUTHID DEFINER IS
BEGIN

    BEGIN
        DBMS_OUTPUT.PUT_LINE(1/n);
    EXCEPTION
        WHEN ZERO_DIVIDE THEN
            DBMS_OUTPUT.PUT_LINE('Error in inner block:');
            DBMS_OUTPUT.PUT_LINE(1/n || ' is undefined.');
```

END;

```

EXCEPTION
    WHEN ZERO_DIVIDE THEN -- handles exception raised in exception handler
        DBMS_OUTPUT.PUT('Error in outer block: ');
        DBMS_OUTPUT.PUT_LINE('1/0 is undefined.');
```

END;

```

/

BEGIN
    print_reciprocal(0);
END;
/
```

Result:

```

Error in inner block:
Error in outer block: 1/0 is undefined.
```

Example 11-21 Exception Raised in Exception Handler is Not Handled

```

CREATE PROCEDURE descending_reciprocals (n INTEGER) AUTHID DEFINER IS
    i INTEGER;
    i_is_one EXCEPTION;
BEGIN
    i := n;

    LOOP
        IF i = 1 THEN
            RAISE i_is_one;
        ELSE
            DBMS_OUTPUT.PUT_LINE('Reciprocal of ' || i || ' is ' || 1/i);
        END IF;

        i := i - 1;
    END LOOP;
EXCEPTION
    WHEN i_is_one THEN
        DBMS_OUTPUT.PUT_LINE('1 is its own reciprocal.');
```

DBMS_OUTPUT.PUT_LINE('Reciprocal of ' || TO_CHAR(i-1) || ' is ' || TO_CHAR(1/(i-1)));

```

    WHEN ZERO_DIVIDE THEN
        DBMS_OUTPUT.PUT_LINE('Error:');
        DBMS_OUTPUT.PUT_LINE(1/n || ' is undefined');
```

END;

```

/

BEGIN
    descending_reciprocals(3);
```

 **See Also:**

- *Oracle Database PL/SQL Packages and Types Reference* for information about the `DBMS_UTILITY.FORMAT_ERROR_BACKTRACE` function, which displays the call stack at the point where an exception was raised, even if the subprogram is called from an exception handler in an outer scope
- *Oracle Database PL/SQL Packages and Types Reference* for information about the `UTL_CALL_STACK` package, whose subprograms provide information about currently executing subprograms, including subprogram names

Example 11-23 Displaying SQLCODE and SQLERRM Values

```

DROP TABLE errors;
CREATE TABLE errors (
  code      NUMBER,
  message   VARCHAR2(64)
);

CREATE OR REPLACE PROCEDURE p AUTHID DEFINER AS
  name      EMPLOYEES.LAST_NAME%TYPE;
  v_code    NUMBER;
  v_errm    VARCHAR2(64);
BEGIN
  SELECT last_name INTO name
  FROM EMPLOYEES
  WHERE EMPLOYEE_ID = -1;
EXCEPTION
  WHEN OTHERS THEN
    v_code := SQLCODE;
    v_errm := SUBSTR(SQLERRM, 1, 64);
    DBMS_OUTPUT.PUT_LINE
      ('Error code ' || v_code || ': ' || v_errm);

  /* Invoke another procedure,
  declared with PRAGMA AUTONOMOUS_TRANSACTION,
  to insert information about errors. */

  INSERT INTO errors (code, message)
  VALUES (v_code, v_errm);

  RAISE;
END;
/

```

11.11 Continuing Execution After Handling Exceptions

After an exception handler runs, control transfers to the next statement of the enclosing block (or to the invoker or host environment if there is no enclosing block). The exception handler cannot transfer control back to its own block.

For example, in [Example 11-24](#), after the `SELECT INTO` statement raises `ZERO_DIVIDE` and the exception handler handles it, execution cannot continue from the `INSERT` statement that follows the `SELECT INTO` statement.

If you want execution to resume with the `INSERT` statement that follows the `SELECT INTO` statement, then put the `SELECT INTO` statement in an inner block with its own `ZERO_DIVIDE` exception handler, as in [Example 11-25](#).



See Also:

[Example 12-13](#), where a bulk SQL operation continues despite exceptions

Example 11-24 Exception Handler Runs and Execution Ends

```
DROP TABLE employees_temp;
CREATE TABLE employees_temp AS
  SELECT employee_id, salary, commission_pct
  FROM employees;

DECLARE
  sal_calc NUMBER(8,2);
BEGIN
  INSERT INTO employees_temp (employee_id, salary, commission_pct)
  VALUES (301, 2500, 0);

  SELECT (salary / commission_pct) INTO sal_calc
  FROM employees_temp
  WHERE employee_id = 301;

  INSERT INTO employees_temp VALUES (302, sal_calc/100, .1);
  DBMS_OUTPUT.PUT_LINE('Row inserted.');
```

EXCEPTION

```
  WHEN ZERO_DIVIDE THEN
    DBMS_OUTPUT.PUT_LINE('Division by zero.');
```

END;

/

Result:

Division by zero.

Example 11-25 Exception Handler Runs and Execution Continues

```
DECLARE
  sal_calc NUMBER(8,2);
BEGIN
  INSERT INTO employees_temp (employee_id, salary, commission_pct)
  VALUES (301, 2500, 0);

  BEGIN
    SELECT (salary / commission_pct) INTO sal_calc
    FROM employees_temp
    WHERE employee_id = 301;
  EXCEPTION
    WHEN ZERO_DIVIDE THEN
      DBMS_OUTPUT.PUT_LINE('Substituting 2500 for undefined number.');
```

sal_calc := 2500;

```

END;

INSERT INTO employees_temp VALUES (302, sal_calc/100, .1);
DBMS_OUTPUT.PUT_LINE('Enclosing block: Row inserted.');
```

EXCEPTION

```

    WHEN ZERO_DIVIDE THEN
        DBMS_OUTPUT.PUT_LINE('Enclosing block: Division by zero.');
```

END;

/

Result:

Substituting 2500 for undefined number.
Enclosing block: Row inserted.

11.12 Retrying Transactions After Handling Exceptions

To retry a transaction after handling an exception that it raised, use this technique:

1. Enclose the transaction in a sub-block that has an exception-handling part.
2. In the sub-block, before the transaction starts, mark a savepoint.
3. In the exception-handling part of the sub-block, put an exception handler that rolls back to the savepoint and then tries to correct the problem.
4. Put the sub-block inside a LOOP statement.
5. In the sub-block, after the COMMIT statement that ends the transaction, put an EXIT statement.

If the transaction succeeds, the COMMIT and EXIT statements execute.

If the transaction fails, control transfers to the exception-handling part of the sub-block, and after the exception handler runs, the loop repeats.

Example 11-26 Retrying Transaction After Handling Exception

```

DROP TABLE results;
CREATE TABLE results (
    res_name VARCHAR(20),
    res_answer VARCHAR2(3)
);

CREATE UNIQUE INDEX res_name_ix ON results (res_name);
INSERT INTO results (res_name, res_answer) VALUES ('SMYTHE', 'YES');
INSERT INTO results (res_name, res_answer) VALUES ('JONES', 'NO');
```

```

DECLARE
    name VARCHAR2(20) := 'SMYTHE';
    answer VARCHAR2(3) := 'NO';
    suffix NUMBER := 1;
BEGIN
    FOR i IN 1..5 LOOP -- Try transaction at most 5 times.

        DBMS_OUTPUT.PUT('Try #' || i);

        BEGIN -- sub-block begins

            SAVEPOINT start_transaction;

            -- transaction begins
```

```

DELETE FROM results WHERE res_answer = 'NO';

INSERT INTO results (res_name, res_answer) VALUES (name, answer);

-- Nonunique name raises DUP_VAL_ON_INDEX.

-- If transaction succeeded:

COMMIT;
DBMS_OUTPUT.PUT_LINE(' succeeded. ');
EXIT;

EXCEPTION
  WHEN DUP_VAL_ON_INDEX THEN
    DBMS_OUTPUT.PUT_LINE(' failed; trying again. ');
    ROLLBACK TO start_transaction;    -- Undo changes.
    suffix := suffix + 1;             -- Try to fix problem.
    name := name || TO_CHAR(suffix);
  END;  -- sub-block ends

END LOOP;
END;
/

```

Result:

```

Try #1 failed; trying again.
Try #2 succeeded.

```

[Example 11-26](#) uses the preceding technique to retry a transaction whose `INSERT` statement raises the predefined exception `DUP_VAL_ON_INDEX` if the value of `res_name` is not unique.

11.13 Handling Errors in Distributed Queries

You can use a trigger or a stored subprogram to create a distributed query. This distributed query is decomposed by the local Oracle Database instance into a corresponding number of remote queries, which are sent to the remote nodes for execution. The remote nodes run the queries and send the results back to the local node. The local node then performs any necessary post-processing and returns the results to the user or application.

If a portion of a distributed statement fails, possibly from a constraint violation, then Oracle Database returns `ORA-02055`. Subsequent statements, or subprogram invocations, return `ORA-02067` until a rollback or a rollback to savepoint is entered.

Design your application to check for any returned error messages that indicates that a portion of the distributed update has failed. If you detect a failure, rollback the entire transaction (or rollback to a savepoint) before allowing the application to proceed.

12

PL/SQL Optimization and Tuning

This chapter explains how the PL/SQL compiler optimizes your code and how to write efficient PL/SQL code and improve existing PL/SQL code.

Topics

- [PL/SQL Optimizer](#)
- [Candidates for Tuning](#)
- [Minimizing CPU Overhead](#)
- [Bulk SQL and Bulk Binding](#)
- [Chaining Pipelined Table Functions for Multiple Transformations](#)
- [Overview of Polymorphic Table Functions](#)
- [Updating Large Tables in Parallel](#)
- [Collecting Data About User-Defined Identifiers](#)
- [Profiling and Tracing PL/SQL Programs](#)
- [Compiling PL/SQL Units for Native Execution](#)



See Also:

Oracle Database Development Guide for disadvantages of cursor variables

12.1 PL/SQL Optimizer

Prior to Oracle Database 10g release 1, the PL/SQL compiler translated your source text to system code without applying many changes to improve performance. Now, PL/SQL uses an optimizer that can rearrange code for better performance.

The optimizer is enabled by default. In rare cases, if the overhead of the optimizer makes compilation of very large applications too slow, you can lower the optimization by setting the compilation parameter `PLSQL_OPTIMIZE_LEVEL=1` instead of its default value 2. In even rarer cases, PL/SQL might raise an exception earlier than expected or not at all. Setting `PLSQL_OPTIMIZE_LEVEL=1` prevents the code from being rearranged.

 **See Also:**

- *Oracle Database Reference* for information about the `PLSQL_OPTIMIZE_LEVEL` compilation parameter
- *Oracle Database Development Guide* for examples of changing the `PLSQL_OPTIMIZE_LEVEL` compilation parameter
- *Oracle Database Reference* for information about the static dictionary view `ALL_PLSQL_OBJECT_SETTINGS`

12.1.1 Subprogram Inlining

One optimization that the compiler can perform is **subprogram inlining**.

Subprogram inlining replaces a subprogram invocation with a copy of the invoked subprogram (if the invoked and invoking subprograms are in the same program unit). To allow subprogram inlining, either accept the default value of the `PLSQL_OPTIMIZE_LEVEL` compilation parameter (which is 2) or set it to 3.

With `PLSQL_OPTIMIZE_LEVEL=2`, you must specify each subprogram to be inlined with the `INLINE` pragma:

```
PRAGMA INLINE (subprogram, 'YES')
```

If *subprogram* is overloaded, then the preceding pragma applies to every subprogram with that name.

With `PLSQL_OPTIMIZE_LEVEL=3`, the PL/SQL compiler seeks opportunities to inline subprograms. You need not specify subprograms to be inlined. However, you can use the `INLINE` pragma (with the preceding syntax) to give a subprogram a high priority for inlining, and then the compiler inlines it unless other considerations or limits make the inlining undesirable.

If a particular subprogram is inlined, performance almost always improves. However, because the compiler inlines subprograms early in the optimization process, it is possible for subprogram inlining to preclude later, more powerful optimizations.

If subprogram inlining slows the performance of a particular PL/SQL program, then use the PL/SQL hierarchical profiler to identify subprograms for which you want to turn off inlining. To turn off inlining for a subprogram, use the `INLINE` pragma:

```
PRAGMA INLINE (subprogram, 'NO')
```

The `INLINE` pragma affects only the immediately following declaration or statement, and only some kinds of statements.

When the `INLINE` pragma immediately precedes a declaration, it affects:

- Every invocation of the specified subprogram in that declaration
- Every initialization value in that declaration except the default initialization values of records

When the `INLINE` pragma immediately precedes one of these statements, the pragma affects every invocation of the specified subprogram in that statement:

- Assignment
- CALL
- Conditional
- CASE
- CONTINUE WHEN
- EXECUTE IMMEDIATE
- EXIT WHEN
- LOOP
- RETURN

The `INLINE` pragma does not affect statements that are not in the preceding list.

Multiple pragmas can affect the same declaration or statement. Each pragma applies its own effect to the statement. If `PRAGMA INLINE(subprogram,'YES')` and `PRAGMA INLINE(identifier,'NO')` have the same `subprogram`, then `'NO'` overrides `'YES'`. One `PRAGMA INLINE(subprogram,'NO')` overrides any number of occurrences of `PRAGMA INLINE(subprogram,'YES')`, and the order of these pragmas is not important.

See Also:

- *Oracle Database Development Guide* for more information about PL/SQL hierarchical profiler
- *Oracle Database Reference* for information about the `PLSQL_OPTIMIZE_LEVEL` compilation parameter
- *Oracle Database Reference* for information about the static dictionary view `ALL_PLSQL_OBJECT_SETTINGS`

Example 12-1 Specifying that Subprogram Is To Be Inlined

In this example, if `PLSQL_OPTIMIZE_LEVEL=2`, the `INLINE` pragma affects the procedure invocations `p1(1)` and `p1(2)`, but not the procedure invocations `p1(3)` and `p1(4)`.

```
PROCEDURE p1 (x PLS_INTEGER) IS ...
...
PRAGMA INLINE (p1, 'YES');
x:= p1(1) + p1(2) + 17;    -- These 2 invocations to p1 are inlined
...
x:= p1(3) + p1(4) + 17;    -- These 2 invocations to p1 are not inlined
...
```

Example 12-2 Specifying that Overloaded Subprogram Is To Be Inlined

In this example, if `PLSQL_OPTIMIZE_LEVEL=2`, the `INLINE` pragma affects both functions named `p2`.

```
FUNCTION p2 (p boolean) return PLS_INTEGER IS ...
FUNCTION p2 (x PLS_INTEGER) return PLS_INTEGER IS ...
...
```



```
PRAGMA INLINE (p2, 'YES');
x := p2(true) + p2(3);

...

```

Example 12-3 Specifying that Subprogram Is Not To Be Inlined

In this example, the `INLINE` pragma affects the procedure invocations `p1(1)` and `p1(2)`, but not the procedure invocations `p1(3)` and `p1(4)`.

```
PROCEDURE p1 (x PLS_INTEGER) IS ...
...
PRAGMA INLINE (p1, 'NO');
x:= p1(1) + p1(2) + 17;    -- These 2 invocations to p1 are not inlined
...
x:= p1(3) + p1(4) + 17;    -- These 2 invocations to p1 might be inlined
...

```

Example 12-4 PRAGMA INLINE ... 'NO' Overrides PRAGMA INLINE ... 'YES'

In this example, the second `INLINE` pragma overrides both the first and third `INLINE` pragmas.

```
PROCEDURE p1 (x PLS_INTEGER) IS ...
...
PRAGMA INLINE (p1, 'YES');
PRAGMA INLINE (p1, 'NO');
PRAGMA INLINE (p1, 'YES');
x:= p1(1) + p1(2) + 17;    -- These 2 invocations to p1 are not inlined
...

```

12.2 Candidates for Tuning

The following kinds of PL/SQL code are very likely to benefit from tuning:

- Older code that does not take advantage of new PL/SQL language features.

Tip:

Before tuning older code, benchmark the current system and profile the older subprograms that your program invokes (see "[Profiling and Tracing PL/SQL Programs](#)"). With the many automatic optimizations of the PL/SQL optimizer (described in "[PL/SQL Optimizer](#)"), you might see performance improvements before doing any tuning.

- Older dynamic SQL statements written with the `DBMS_SQL` package.

If you know at compile time the number and data types of the input and output variables of a dynamic SQL statement, then you can rewrite the statement in native dynamic SQL, which runs noticeably faster than equivalent code that uses the `DBMS_SQL` package (especially when it can be optimized by the compiler). For more information, see [PL/SQL Dynamic SQL](#).

- Code that spends much time processing SQL statements.
See "[Tune SQL Statements](#)".
- Functions invoked in queries, which might run millions of times.

- See "[Tune Function Invocations in Queries](#)".
- Code that spends much time looping through query results.
See "[Tune Loops](#)".
- Code that does many numeric computations.
See "[Tune Computation-Intensive PL/SQL Code](#)".
- Code that spends much time processing PL/SQL statements (as opposed to issuing database definition language (DDL) statements that PL/SQL passes directly to SQL).
See "[Compiling PL/SQL Units for Native Execution](#)".

12.3 Minimizing CPU Overhead

Topics

- [Tune SQL Statements](#)
- [Tune Function Invocations in Queries](#)
- [Tune Subprogram Invocations](#)
- [Tune Loops](#)
- [Tune Computation-Intensive PL/SQL Code](#)
- [Use SQL Character Functions](#)
- [Put Least Expensive Conditional Tests First](#)

12.3.1 Tune SQL Statements

The most common cause of slowness in PL/SQL programs is slow SQL statements. To make SQL statements in a PL/SQL program as efficient as possible:

- Use appropriate indexes.
For details, see *Oracle Database Performance Tuning Guide*.
- Use query hints to avoid unnecessary full-table scans.
For details, see *Oracle Database SQL Language Reference*.
- Collect current statistics on all tables, using the subprograms in the `DBMS_STATS` package.
For details, see *Oracle Database Performance Tuning Guide*.
- Analyze the execution plans and performance of the SQL statements, using:
 - `EXPLAIN PLAN` statement
For details, see *Oracle Database Performance Tuning Guide*.
 - SQL Trace facility with `TKPROF` utility
For details, see *Oracle Database Performance Tuning Guide*.
- Use bulk SQL, a set of PL/SQL features that minimizes the performance overhead of the communication between PL/SQL and SQL.
For details, see "[Bulk SQL and Bulk Binding](#)".

12.3.2 Tune Function Invocations in Queries

Functions invoked in queries might run millions of times. Do not invoke a function in a query unnecessarily, and make the invocation as efficient as possible.

Create a function-based index on the table in the query. The `CREATE INDEX` statement might take a while, but the query can run much faster because the function value for each row is cached.

If the query passes a column to a function, then the query cannot use user-created indexes on that column, so the query might invoke the function for every row of the table (which might be very large). To minimize the number of function invocations, use a nested query. Have the inner query filter the result set to a small number of rows, and have the outer query invoke the function for only those rows.

See Also:

- *Oracle Database SQL Language Reference* for more information about `CREATE INDEX` statement syntax
- "[PL/SQL Function Result Cache](#)" for information about caching the results of PL/SQL functions

Example 12-5 Nested Query Improves Performance

In this example, the two queries produce the same result set, but the second query is more efficient than the first. (In the example, the times and time difference are very small, because the `EMPLOYEES` table is very small. For a very large table, they would be significant.)

```
DECLARE
  starting_time  TIMESTAMP WITH TIME ZONE;
  ending_time    TIMESTAMP WITH TIME ZONE;
BEGIN
  -- Invokes SQRT for every row of employees table:

  SELECT SYSTIMESTAMP INTO starting_time FROM DUAL;

  FOR item IN (
    SELECT DISTINCT(SQRT(department_id)) col_alias
    FROM employees
    ORDER BY col_alias
  )
  LOOP
    DBMS_OUTPUT.PUT_LINE('Square root of dept. ID = ' || item.col_alias);
  END LOOP;

  SELECT SYSTIMESTAMP INTO ending_time FROM DUAL;

  DBMS_OUTPUT.PUT_LINE('Time = ' || TO_CHAR(ending_time - starting_time));

  -- Invokes SQRT for every distinct department_id of employees table:

  SELECT SYSTIMESTAMP INTO starting_time FROM DUAL;
```

```

FOR item IN (
  SELECT SQRT(department_id) col_alias
  FROM (SELECT DISTINCT department_id FROM employees)
  ORDER BY col_alias
)
LOOP
  IF item.col_alias IS NOT NULL THEN
    DBMS_OUTPUT.PUT_LINE('Square root of dept. ID = ' || item.col_alias);
  END IF;
END LOOP;

SELECT SYSTIMESTAMP INTO ending_time FROM DUAL;

DBMS_OUTPUT.PUT_LINE('Time = ' || TO_CHAR(ending_time - starting_time));
END;
/

```

Result is similar to:

```

Square root of dept. ID = 3.16227766016837933199889354443271853372
Square root of dept. ID = 4.47213595499957939281834733746255247088
Square root of dept. ID = 5.47722557505166113456969782800802133953
Square root of dept. ID = 6.32455532033675866399778708886543706744
Square root of dept. ID = 7.07106781186547524400844362104849039285
Square root of dept. ID = 7.74596669241483377035853079956479922167
Square root of dept. ID = 8.36660026534075547978172025785187489393
Square root of dept. ID = 8.94427190999915878563669467492510494176
Square root of dept. ID = 9.48683298050513799599668063329815560116
Square root of dept. ID = 10
Square root of dept. ID = 10.48808848170151546991453513679937598475
Time = +000000000 00:00:00.046000000
Square root of dept. ID = 3.16227766016837933199889354443271853372
Square root of dept. ID = 4.47213595499957939281834733746255247088
Square root of dept. ID = 5.47722557505166113456969782800802133953
Square root of dept. ID = 6.32455532033675866399778708886543706744
Square root of dept. ID = 7.07106781186547524400844362104849039285
Square root of dept. ID = 7.74596669241483377035853079956479922167
Square root of dept. ID = 8.36660026534075547978172025785187489393
Square root of dept. ID = 8.94427190999915878563669467492510494176
Square root of dept. ID = 9.48683298050513799599668063329815560116
Square root of dept. ID = 10
Square root of dept. ID = 10.48808848170151546991453513679937598475
Time = +000000000 00:00:00.000000000

```

12.3.3 Tune Subprogram Invocations

If a subprogram has `OUT` or `IN OUT` parameters, you can sometimes decrease its invocation overhead by declaring those parameters with the `NOCOPY` hint.

When `OUT` or `IN OUT` parameters represent large data structures such as collections, records, and instances of ADTs, copying them slows execution and increases memory use—especially for an instance of an ADT.

For each invocation of an ADT method, PL/SQL copies every attribute of the ADT. If the method is exited normally, then PL/SQL applies any changes that the method made to the attributes. If the method is exited with an unhandled exception, then PL/SQL does not change the attributes.

If your program does not require that an `OUT` or `IN OUT` parameter retain its pre-invocation value if the subprogram ends with an unhandled exception, then include the `NOCOPY` hint in

the parameter declaration. The `NOCOPY` hint requests (but does not ensure) that the compiler pass the corresponding actual parameter by reference instead of value.

Caution:

Do not rely on `NOCOPY` (which the compiler might or might not obey for a particular invocation) to ensure that an actual parameter or ADT attribute retains its pre-invocation value if the subprogram is exited with an unhandled exception. Instead, ensure that the subprogram handle all exceptions.

See Also:

- "[NOCOPY](#)" for more information about `NOCOPY` hint
- *Oracle Database Object-Relational Developer's Guide* for information about using `NOCOPY` with member methods of ADTs

Example 12-6 `NOCOPY` Subprogram Parameters

In this example, if the compiler obeys the `NOCOPY` hint for the invocation of `do_nothing2`, then the invocation of `do_nothing2` is faster than the invocation of `do_nothing1`.

```

DECLARE
  TYPE EmpTabTyp IS TABLE OF employees%ROWTYPE;
  emp_tab EmpTabTyp := EmpTabTyp(NULL); -- initialize
  t1 NUMBER;
  t2 NUMBER;
  t3 NUMBER;

  PROCEDURE get_time (t OUT NUMBER) IS
  BEGIN
    t := DBMS_UTILITY.get_time;
  END;

  PROCEDURE do_nothing1 (tab IN OUT EmpTabTyp) IS
  BEGIN
    NULL;
  END;

  PROCEDURE do_nothing2 (tab IN OUT NOCOPY EmpTabTyp) IS
  BEGIN
    NULL;
  END;

BEGIN
  SELECT * INTO emp_tab(1)
  FROM employees
  WHERE employee_id = 100;

  emp_tab.EXTEND(49999, 1); -- Copy element 1 into 2..50000
  get_time(t1);
  do_nothing1(emp_tab); -- Pass IN OUT parameter

```

```
get_time(t2);
do_nothing2(emp_tab); -- Pass IN OUT NOCOPY parameter
get_time(t3);
DBMS_OUTPUT.PUT_LINE ('Call Duration (secs)');
DBMS_OUTPUT.PUT_LINE ('-----');
DBMS_OUTPUT.PUT_LINE ('Just IN OUT: ' || TO_CHAR((t2 - t1)/100.0));
DBMS_OUTPUT.PUT_LINE ('With NOCOPY: ' || TO_CHAR((t3 - t2)/100.0));
END;
/
```

12.3.4 Tune Loops

Because PL/SQL applications are often built around loops, it is important to optimize both the loops themselves and the code inside them.

If you must loop through a result set more than once, or issue other queries as you loop through a result set, you might be able to change the original query to give you exactly the results you want. Explore the SQL set operators that let you combine multiple queries, described in *Oracle Database SQL Language Reference*.

You can also use subqueries to do the filtering and sorting in multiple stages—see "[Processing Query Result Sets with Subqueries](#)".



See Also:

["Bulk SQL and Bulk Binding"](#)

12.3.5 Tune Computation-Intensive PL/SQL Code

These recommendations apply especially (but not only) to computation-intensive PL/SQL code.

Topics

- [Use Data Types that Use Hardware Arithmetic](#)
- [Avoid Constrained Subtypes in Performance-Critical Code](#)
- [Minimize Implicit Data Type Conversion](#)

12.3.5.1 Use Data Types that Use Hardware Arithmetic

Avoid using data types in the `NUMBER` data type family (described in "[NUMBER Data Type Family](#)"). These data types are represented internally in a format designed for portability and arbitrary scale and precision, not for performance. Operations on data of these types use library arithmetic, while operations on data of the types `PLS_INTEGER`, `BINARY_FLOAT` and `BINARY_DOUBLE` use hardware arithmetic.

For local integer variables, use `PLS_INTEGER`, described in "[PLS_INTEGER and BINARY_INTEGER Data Types](#)". For variables used in performance-critical code, that can never have the value `NULL`, and do not need overflow checking, use `SIMPLE_INTEGER`, described in "[SIMPLE_INTEGER Subtype of PLS_INTEGER](#)".

For floating-point variables, use `BINARY_FLOAT` or `BINARY_DOUBLE`, described in *Oracle Database SQL Language Reference*. For variables used in performance-critical code, that can never have the value `NULL`, and that do not need overflow checking, use `SIMPLE_FLOAT` or `SIMPLE_DOUBLE`, explained in "[Additional PL/SQL Subtypes of `BINARY_FLOAT` and `BINARY_DOUBLE`](#)".

 **Note:**

`BINARY_FLOAT` and `BINARY_DOUBLE` and their subtypes are less suitable for financial code where accuracy is critical, because they do not always represent fractional values precisely, and handle rounding differently than the `NUMBER` types.

Many SQL numeric functions (described in *Oracle Database SQL Language Reference*) are overloaded with versions that accept `BINARY_FLOAT` and `BINARY_DOUBLE` parameters. You can speed up computation-intensive code by passing variables of these data types to such functions, and by invoking the conversion functions `TO_BINARY_FLOAT` (described in *Oracle Database SQL Language Reference*) and `TO_BINARY_DOUBLE` (described in *Oracle Database SQL Language Reference*) when passing expressions to such functions.

12.3.5.2 Avoid Constrained Subtypes in Performance-Critical Code

In performance-critical code, avoid constrained subtypes (described in "[Constrained Subtypes](#)"). Each assignment to a variable or parameter of a constrained subtype requires extra checking at run time to ensure that the value to be assigned does not violate the constraint.

 **See Also:**

[PL/SQL Predefined Data Types](#) includes predefined constrained subtypes

12.3.5.3 Minimize Implicit Data Type Conversion

At run time, PL/SQL converts between different data types implicitly (automatically) if necessary. For example, if you assign a `PLS_INTEGER` variable to a `NUMBER` variable, then PL/SQL converts the `PLS_INTEGER` value to a `NUMBER` value (because the internal representations of the values differ).

Whenever possible, minimize implicit conversions. For example:

- If a variable is to be either inserted into a table column or assigned a value from a table column, then give the variable the same data type as the table column.

 **Tip:**

Declare the variable with the `%TYPE` attribute, described in "[%TYPE Attribute](#)".

- Make each literal the same data type as the variable to which it is assigned or the expression in which it appears.
- Convert values from SQL data types to PL/SQL data types and then use the converted values in expressions.

For example, convert `NUMBER` values to `PLS_INTEGER` values and then use the `PLS_INTEGER` values in expressions. `PLS_INTEGER` operations use hardware arithmetic, so they are faster than `NUMBER` operations, which use library arithmetic. For more information about the `PLS_INTEGER` data type, see "[PLS_INTEGER and BINARY_INTEGER Data Types](#)".

- Before assigning a value of one SQL data type to a variable of another SQL data type, explicitly convert the source value to the target data type, using a SQL conversion function (for information about SQL conversion functions, see *Oracle Database SQL Language Reference*).
- Overload your subprograms with versions that accept parameters of different data types and optimize each version for its parameter types. For information about overloaded subprograms, see "[Overloaded Subprograms](#)".

 **See Also:**

- *Oracle Database SQL Language Reference* for information about implicit conversion of SQL data types (which are also PL/SQL data types)
- "[Subtypes with Base Types in Same Data Type Family](#)"

12.3.6 Use SQL Character Functions

SQL has many highly optimized character functions, which use low-level code that is more efficient than PL/SQL code. Use these functions instead of writing PL/SQL code to do the same things.

 **See:**

- *Oracle Database SQL Language Reference* for information about SQL character functions that return character values
- *Oracle Database SQL Language Reference* for information about SQL character functions that return NLS character values
- *Oracle Database SQL Language Reference* for information about SQL character functions that return number values
- [Example 6-6](#) for an example of PL/SQL code that uses SQL character function `REGEXP_LIKE`

12.3.7 Put Least Expensive Conditional Tests First

PL/SQL stops evaluating a logical expression as soon as it can determine the result. Take advantage of this short-circuit evaluation by putting the conditions that are least expensive to evaluate first in logical expressions whenever possible. For example, test the values of PL/SQL variables before testing function return values, so that if the variable tests fail, PL/SQL need not invoke the functions:

```
IF boolean_variable OR (number > 10) OR boolean_function(parameter) THEN ...
```



See Also:

"Short-Circuit Evaluation"

12.4 Bulk SQL and Bulk Binding

Bulk SQL minimizes the performance overhead of the communication between PL/SQL and SQL. The PL/SQL features that comprise bulk SQL are the `FORALL` statement and the `BULK COLLECT` clause. Assigning values to PL/SQL variables that appear in SQL statements is called **binding**.

PL/SQL and SQL communicate as follows: To run a `SELECT INTO` or DML statement, the PL/SQL engine sends the query or DML statement to the SQL engine. The SQL engine runs the query or DML statement and returns the result to the PL/SQL engine.

The `FORALL` statement sends DML statements from PL/SQL to SQL in batches rather than one at a time. The `BULK COLLECT` clause returns results from SQL to PL/SQL in batches rather than one at a time. If a query or DML statement affects four or more database rows, then bulk SQL can significantly improve performance.



Note:

You cannot perform bulk SQL on remote tables.

PL/SQL binding operations fall into these categories:

Binding Category	When This Binding Occurs
In-bind	When an <code>INSERT</code> , <code>UPDATE</code> , or <code>MERGE</code> statement stores a PL/SQL or host variable in the database
Out-bind	When the <code>RETURNING INTO</code> clause of an <code>INSERT</code> , <code>UPDATE</code> , or <code>DELETE</code> statement assigns a database value to a PL/SQL or host variable
DEFINE	When a <code>SELECT</code> or <code>FETCH</code> statement assigns a database value to a PL/SQL or host variable

For in-binds and out-binds, bulk SQL uses **bulk binding**; that is, it binds an entire collection of values at once. For a collection of n elements, bulk SQL uses a single operation to perform the equivalent of n `SELECT INTO` or DML statements. A query that

uses bulk SQL can return any number of rows, without using a `FETCH` statement for each one.

**Note:**

Parallel DML is disabled with bulk SQL.

Topics

- [FORALL Statement](#)
- [BULK COLLECT Clause](#)
- [Using FORALL Statement and BULK COLLECT Clause Together](#)
- [Client Bulk-Binding of Host Arrays](#)

12.4.1 FORALL Statement

The `FORALL` statement, a feature of bulk SQL, sends DML statements from PL/SQL to SQL in batches rather than one at a time.

To understand the `FORALL` statement, first consider the `FOR LOOP` statement in [Example 12-7](#). It sends these DML statements from PL/SQL to SQL one at a time:

```
DELETE FROM employees_temp WHERE department_id = depts(10);  
DELETE FROM employees_temp WHERE department_id = depts(30);  
DELETE FROM employees_temp WHERE department_id = depts(70);
```

Now consider the `FORALL` statement in [Example 12-8](#). It sends the same three DML statements from PL/SQL to SQL as a batch.

A `FORALL` statement is usually much faster than an equivalent `FOR LOOP` statement. However, a `FOR LOOP` statement can contain multiple DML statements, while a `FORALL` statement can contain only one. The batch of DML statements that a `FORALL` statement sends to SQL differ only in their `VALUES` and `WHERE` clauses. The values in those clauses must come from existing, populated collections.

**Note:**

The DML statement in a `FORALL` statement can reference multiple collections, but performance benefits apply only to collection references that use the `FORALL` index variable as an index.

[Example 12-9](#) inserts the same collection elements into two database tables, using a `FOR LOOP` statement for the first table and a `FORALL` statement for the second table and showing how long each statement takes. (Times vary from run to run.)

In [Example 12-10](#), the `FORALL` statement applies to a subset of a collection.

Topics

- [Using FORALL Statements for Sparse Collections](#)

- [Unhandled Exceptions in FORALL Statements](#)
- [Handling FORALL Exceptions Immediately](#)
- [Handling FORALL Exceptions After FORALL Statement Completes](#)
- [Getting Number of Rows Affected by FORALL Statement](#)

 **See Also:**

- ["FORALL Statement"](#) for its complete syntax and semantics, including restrictions
- ["Implicit Cursors"](#) for information about implicit cursor attributes in general and other implicit cursor attributes that you can use with the FORALL statement

Example 12-7 DELETE Statement in FOR LOOP Statement

```
DROP TABLE employees_temp;
CREATE TABLE employees_temp AS SELECT * FROM employees;

DECLARE
    TYPE NumList IS VARRAY(20) OF NUMBER;
    depts NumList := NumList(10, 30, 70); -- department numbers
BEGIN
    FOR i IN depts.FIRST..depts.LAST LOOP
        DELETE FROM employees_temp
            WHERE department_id = depts(i);
    END LOOP;
END;
/
```

Example 12-8 DELETE Statement in FORALL Statement

```
DROP TABLE employees_temp;
CREATE TABLE employees_temp AS SELECT * FROM employees;

DECLARE
    TYPE NumList IS VARRAY(20) OF NUMBER;
    depts NumList := NumList(10, 30, 70); -- department numbers
BEGIN
    FORALL i IN depts.FIRST..depts.LAST
        DELETE FROM employees_temp
            WHERE department_id = depts(i);
END;
/
```

Example 12-9 Time Difference for INSERT Statement in FOR LOOP and FORALL Statements

```
DROP TABLE parts1;
CREATE TABLE parts1 (
    pnum INTEGER,
    pname VARCHAR2(15)
);

DROP TABLE parts2;
```

```

CREATE TABLE parts2 (
  pnum INTEGER,
  pname VARCHAR2(15)
);

DECLARE
  TYPE NumTab IS TABLE OF parts1.pnum%TYPE INDEX BY PLS_INTEGER;
  TYPE NameTab IS TABLE OF parts1.pname%TYPE INDEX BY PLS_INTEGER;
  pnums NumTab;
  pnames NameTab;
  iterations CONSTANT PLS_INTEGER := 50000;
  t1 INTEGER;
  t2 INTEGER;
  t3 INTEGER;
BEGIN
  FOR j IN 1..iterations LOOP -- populate collections
    pnums(j) := j;
    pnames(j) := 'Part No. ' || TO_CHAR(j);
  END LOOP;

  t1 := DBMS_UTILITY.get_time;

  FOR i IN 1..iterations LOOP
    INSERT INTO parts1 (pnum, pname)
      VALUES (pnums(i), pnames(i));
  END LOOP;

  t2 := DBMS_UTILITY.get_time;

  FORALL i IN 1..iterations
    INSERT INTO parts2 (pnum, pname)
      VALUES (pnums(i), pnames(i));

  t3 := DBMS_UTILITY.get_time;

  DBMS_OUTPUT.PUT_LINE('Execution Time (secs)');
  DBMS_OUTPUT.PUT_LINE('-----');
  DBMS_OUTPUT.PUT_LINE('FOR LOOP: ' || TO_CHAR((t2 - t1)/100));
  DBMS_OUTPUT.PUT_LINE('FORALL:   ' || TO_CHAR((t3 - t2)/100));
  COMMIT;
END;
/

```

Result is similar to:

```

Execution Time (secs)
-----
FOR LOOP: 5.97
FORALL:   .07

PL/SQL procedure successfully completed.

```

Example 12-10 FORALL Statement for Subset of Collection

```

DROP TABLE employees_temp;
CREATE TABLE employees_temp AS SELECT * FROM employees;

DECLARE
  TYPE NumList IS VARRAY(10) OF NUMBER;
  depts NumList := NumList(5,10,20,30,50,55,57,60,70,75);
BEGIN

```

```

FORALL j IN 4..7
  DELETE FROM employees_temp WHERE department_id = depts(j);
END;
/

```

12.4.1.1 Using FORALL Statements for Sparse Collections

If the `FORALL` statement bounds clause references a sparse collection, then specify only existing index values, using either the `INDICES OF` or `VALUES OF` clause.

You can use `INDICES OF` for any collection except an associative array indexed by string. You can use `VALUES OF` only for a collection of `PLS_INTEGER` elements indexed by `PLS_INTEGER`.

A collection of `PLS_INTEGER` elements indexed by `PLS_INTEGER` can be an **index collection**; that is, a collection of pointers to elements of another collection (the **indexed collection**).

Index collections are useful for processing different subsets of the same collection with different `FORALL` statements. Instead of copying elements of the original collection into new collections that represent the subsets (which can use significant time and memory), represent each subset with an index collection and then use each index collection in the `VALUES OF` clause of a different `FORALL` statement.



See Also:

["Sparse Collections and SQL%BULK_EXCEPTIONS"](#)

Example 12-11 FORALL Statements for Sparse Collection and Its Subsets

This example uses a `FORALL` statement with the `INDICES OF` clause to populate a table with the elements of a sparse collection. Then it uses two `FORALL` statements with `VALUES OF` clauses to populate two tables with subsets of a collection.

```

DROP TABLE valid_orders;
CREATE TABLE valid_orders (
  cust_name VARCHAR2(32),
  amount    NUMBER(10,2)
);

DROP TABLE big_orders;
CREATE TABLE big_orders AS
  SELECT * FROM valid_orders
  WHERE 1 = 0;

DROP TABLE rejected_orders;
CREATE TABLE rejected_orders AS
  SELECT * FROM valid_orders
  WHERE 1 = 0;

DECLARE
  SUBTYPE cust_name IS valid_orders.cust_name%TYPE;
  TYPE cust_typ IS TABLE OF cust_name;
  cust_tab cust_typ; -- Collection of customer names

  SUBTYPE order_amount IS valid_orders.amount%TYPE;

```

```
TYPE amount_typ IS TABLE OF NUMBER;
amount_tab amount_typ; -- Collection of order amounts

TYPE index_pointer_t IS TABLE OF PLS_INTEGER;

/* Collections for pointers to elements of cust_tab collection
   (to represent two subsets of cust_tab): */

big_order_tab      index_pointer_t := index_pointer_t();
rejected_order_tab index_pointer_t := index_pointer_t();

PROCEDURE populate_data_collections IS
BEGIN
    cust_tab := cust_typ(
        'Company1', 'Company2', 'Company3', 'Company4', 'Company5'
    );

    amount_tab := amount_typ(5000.01, 0, 150.25, 4000.00, NULL);
END;

BEGIN
    populate_data_collections;

    DBMS_OUTPUT.PUT_LINE ('--- Original order data ---');

    FOR i IN 1..cust_tab.LAST LOOP
        DBMS_OUTPUT.PUT_LINE (
            'Customer #' || i || ', ' || cust_tab(i) || ': $' || amount_tab(i)
        );
    END LOOP;

    -- Delete invalid orders:

    FOR i IN 1..cust_tab.LAST LOOP
        IF amount_tab(i) IS NULL OR amount_tab(i) = 0 THEN
            cust_tab.delete(i);
            amount_tab.delete(i);
        END IF;
    END LOOP;

    -- cust_tab is now a sparse collection.

    DBMS_OUTPUT.PUT_LINE ('--- Order data with invalid orders deleted ---');

    FOR i IN 1..cust_tab.LAST LOOP
        IF cust_tab.EXISTS(i) THEN
            DBMS_OUTPUT.PUT_LINE (
                'Customer #' || i || ', ' || cust_tab(i) || ': $' || amount_tab(i)
            );
        END IF;
    END LOOP;

    -- Using sparse collection, populate valid_orders table:

    FORALL i IN INDICES OF cust_tab
        INSERT INTO valid_orders (cust_name, amount)
        VALUES (cust_tab(i), amount_tab(i));

    populate_data_collections; -- Restore original order data

    -- cust_tab is a dense collection again.
```

```

/* Populate collections of pointers to elements of cust_tab collection
(which represent two subsets of cust_tab): */

FOR i IN cust_tab.FIRST .. cust_tab.LAST LOOP
  IF amount_tab(i) IS NULL OR amount_tab(i) = 0 THEN
    rejected_order_tab.EXTEND;
    rejected_order_tab(rejected_order_tab.LAST) := i;
  END IF;

  IF amount_tab(i) > 2000 THEN
    big_order_tab.EXTEND;
    big_order_tab(big_order_tab.LAST) := i;
  END IF;
END LOOP;

/* Using each subset in a different FORALL statement,
populate rejected_orders and big_orders tables: */

FORALL i IN VALUES OF rejected_order_tab
  INSERT INTO rejected_orders (cust_name, amount)
  VALUES (cust_tab(i), amount_tab(i));

FORALL i IN VALUES OF big_order_tab
  INSERT INTO big_orders (cust_name, amount)
  VALUES (cust_tab(i), amount_tab(i));
END;
/

```

Result:

```

--- Original order data ---
Customer #1, Company1: $5000.01
Customer #2, Company2: $0
Customer #3, Company3: $150.25
Customer #4, Company4: $4000
Customer #5, Company5: $
--- Data with invalid orders deleted ---
Customer #1, Company1: $5000.01
Customer #3, Company3: $150.25
Customer #4, Company4: $4000

```

Verify that correct order details were stored:

```

SELECT cust_name "Customer", amount "Valid order amount"
FROM valid_orders
ORDER BY cust_name;

```

Result:

Customer	Valid order amount
Company1	5000.01
Company3	150.25
Company4	4000

3 rows selected.

Query:

```

SELECT cust_name "Customer", amount "Big order amount"

```

```
FROM big_orders
ORDER BY cust_name;
```

Result:

Customer	Big order amount
Company1	5000.01
Company4	4000

2 rows selected.

Query:

```
SELECT cust_name "Customer", amount "Rejected order amount"
FROM rejected_orders
ORDER BY cust_name;
```

Result:

Customer	Rejected order amount
Company2	0
Company5	

2 rows selected.

12.4.1.2 Unhandled Exceptions in FORALL Statements

In a `FORALL` statement without the `SAVE EXCEPTIONS` clause, if one DML statement raises an unhandled exception, then PL/SQL stops the `FORALL` statement and rolls back all changes made by previous DML statements.

For example, the `FORALL` statement in [Example 12-8](#) executes these DML statements in this order, unless one of them raises an unhandled exception:

```
DELETE FROM employees_temp WHERE department_id = depts(10);
DELETE FROM employees_temp WHERE department_id = depts(30);
DELETE FROM employees_temp WHERE department_id = depts(70);
```

If the third statement raises an unhandled exception, then PL/SQL rolls back the changes that the first and second statements made. If the second statement raises an unhandled exception, then PL/SQL rolls back the changes that the first statement made and never runs the third statement.

You can handle exceptions raised in a `FORALL` statement in either of these ways:

- As each exception is raised (see ["Handling FORALL Exceptions Immediately"](#))
- After the `FORALL` statement completes execution, by including the `SAVE EXCEPTIONS` clause (see ["Handling FORALL Exceptions After FORALL Statement Completes"](#))

12.4.1.3 Handling FORALL Exceptions Immediately

To handle exceptions raised in a `FORALL` statement immediately, omit the `SAVE EXCEPTIONS` clause and write the appropriate exception handlers.

If one DML statement raises a handled exception, then PL/SQL rolls back the changes made by that statement, but does not roll back changes made by previous DML statements.

In [Example 12-12](#), the `FORALL` statement is designed to run three `UPDATE` statements. However, the second one raises an exception. An exception handler handles the exception, displaying the error message and committing the change made by the first `UPDATE` statement. The third `UPDATE` statement never runs.

For information about exception handlers, see [PL/SQL Error Handling](#).

Example 12-12 Handling `FORALL` Exceptions Immediately

```
DROP TABLE emp_temp;
CREATE TABLE emp_temp (
  deptno NUMBER(2),
  job VARCHAR2(18)
);

CREATE OR REPLACE PROCEDURE p AUTHID DEFINER AS
  TYPE NumList IS TABLE OF NUMBER;

  depts          NumList := NumList(10, 20, 30);
  error_message VARCHAR2(100);

BEGIN
  -- Populate table:

  INSERT INTO emp_temp (deptno, job) VALUES (10, 'Clerk');
  INSERT INTO emp_temp (deptno, job) VALUES (20, 'Bookkeeper');
  INSERT INTO emp_temp (deptno, job) VALUES (30, 'Analyst');
  COMMIT;

  -- Append 9-character string to each job:

  FORALL j IN depts.FIRST..depts.LAST
    UPDATE emp_temp SET job = job || ' (Senior)'
    WHERE deptno = depts(j);

EXCEPTION
  WHEN OTHERS THEN
    error_message := SQLERRM;
    DBMS_OUTPUT.PUT_LINE (error_message);

    COMMIT; -- Commit results of successful updates
    RAISE;
END;
/
```

Result:

Procedure created.

Invoke procedure:

```
BEGIN
  p;
END;
/
```

Result:

```
ORA-12899: value too large for column "HR"."EMP_TEMP"."JOB" (actual: 19,
maximum: 18)
BEGIN
*
```

```

ERROR at line 1:
ORA-12899: value too large for column "HR"."EMP_TEMP"."JOB" (actual: 19,
maximum: 18)
ORA-06512: at "HR.P", line 27
ORA-06512: at line 2

```

Query:

```
SELECT * FROM emp_temp;
```

Result:

```

DEPTNO JOB
-----
      10 Clerk (Senior)
      20 Bookkeeper
      30 Analyst

3 rows selected.

```

12.4.1.4 Handling FORALL Exceptions After FORALL Statement Completes

To allow a `FORALL` statement to continue even if some of its DML statements fail, include the `SAVE EXCEPTIONS` clause. When a DML statement fails, PL/SQL does not raise an exception; instead, it saves information about the failure. After the `FORALL` statement completes, PL/SQL raises a single exception for the `FORALL` statement (ORA-24381).

In the exception handler for ORA-24381, you can get information about each individual DML statement failure from the implicit cursor attribute `SQL%BULK_EXCEPTIONS`.

`SQL%BULK_EXCEPTIONS` is like an associative array of information about the DML statements that failed during the most recently run `FORALL` statement.

`SQL%BULK_EXCEPTIONS.COUNT` is the number of DML statements that failed. If `SQL%BULK_EXCEPTIONS.COUNT` is not zero, then for each index value i from 1 through `SQL%BULK_EXCEPTIONS.COUNT`:

- `SQL%BULK_EXCEPTIONS(i).ERROR_INDEX` is the number of the DML statement that failed.
- `SQL%BULK_EXCEPTIONS(i).ERROR_CODE` is the Oracle Database error code for the failure.

For example, if a `FORALL SAVE EXCEPTIONS` statement runs 100 DML statements, and the tenth and sixty-fourth ones fail with error codes ORA-12899 and ORA-19278, respectively, then:

- `SQL%BULK_EXCEPTIONS.COUNT = 2`
- `SQL%BULK_EXCEPTIONS(1).ERROR_INDEX = 10`
- `SQL%BULK_EXCEPTIONS(1).ERROR_CODE = 12899`
- `SQL%BULK_EXCEPTIONS(2).ERROR_INDEX = 64`
- `SQL%BULK_EXCEPTIONS(2).ERROR_CODE = 19278`

Note:

After a `FORALL` statement *without* the `SAVE EXCEPTIONS` clause raises an exception, `SQL%BULK_EXCEPTIONS.COUNT = 1`.

With the error code, you can get the associated error message with the `SQLERRM` function (described in "SQLERRM Function"):

```
SQLERRM(-(SQL%BULK_EXCEPTIONS(i).ERROR_CODE))
```

However, the error message that `SQLERRM` returns excludes any substitution arguments (compare the error messages in [Example 12-12](#) and [Example 12-13](#)).

[Example 12-13](#) is like [Example 12-12](#) except:

- The `FORALL` statement includes the `SAVE EXCEPTIONS` clause.
- The exception-handling part has an exception handler for `ORA-24381`, the internally defined exception that PL/SQL raises implicitly when a bulk operation raises and saves exceptions. The example gives `ORA-24381` the user-defined name `dml_errors`.
- The exception handler for `dml_errors` uses `SQL%BULK_EXCEPTIONS` and `SQLERRM` (and some local variables) to show the error message and which statement, collection item, and string caused the error.

Example 12-13 Handling FORALL Exceptions After FORALL Statement Completes

```
CREATE OR REPLACE PROCEDURE p AUTHID DEFINER AS
  TYPE NumList IS TABLE OF NUMBER;
  depts          NumList := NumList(10, 20, 30);

  error_message VARCHAR2(100);
  bad_stmt_no   PLS_INTEGER;
  bad_deptno    emp_temp.deptno%TYPE;
  bad_job       emp_temp.job%TYPE;

  dml_errors    EXCEPTION;
  PRAGMA EXCEPTION_INIT(dml_errors, -24381);
BEGIN
  -- Populate table:

  INSERT INTO emp_temp (deptno, job) VALUES (10, 'Clerk');
  INSERT INTO emp_temp (deptno, job) VALUES (20, 'Bookkeeper');
  INSERT INTO emp_temp (deptno, job) VALUES (30, 'Analyst');
  COMMIT;

  -- Append 9-character string to each job:

  FORALL j IN depts.FIRST..depts.LAST SAVE EXCEPTIONS
    UPDATE emp_temp SET job = job || ' (Senior)'
    WHERE deptno = depts(j);

EXCEPTION
  WHEN dml_errors THEN
    FOR i IN 1..SQL%BULK_EXCEPTIONS.COUNT LOOP
      error_message := SQLERRM(-(SQL%BULK_EXCEPTIONS(i).ERROR_CODE));
      DBMS_OUTPUT.PUT_LINE (error_message);

      bad_stmt_no := SQL%BULK_EXCEPTIONS(i).ERROR_INDEX;
      DBMS_OUTPUT.PUT_LINE('Bad statement #: ' || bad_stmt_no);

      bad_deptno := depts(bad_stmt_no);
      DBMS_OUTPUT.PUT_LINE('Bad department #: ' || bad_deptno);

      SELECT job INTO bad_job FROM emp_temp WHERE deptno = bad_deptno;
```

```

        DBMS_OUTPUT.PUT_LINE('Bad job: ' || bad_job);
    END LOOP;

    COMMIT; -- Commit results of successful updates

    WHEN OTHERS THEN
        DBMS_OUTPUT.PUT_LINE('Unrecognized error. ');
        RAISE;
END;
/

```

Result:

Procedure created.

Invoke procedure:

```

BEGIN
    p;
END;
/

```

Result:

```

ORA-12899: value too large for column (actual: , maximum: )
Bad statement #: 2
Bad department #: 20
Bad job: Bookkeeper

```

PL/SQL procedure successfully completed.

Query:

```

SELECT * FROM emp_temp;

```

Result:

```

    DEPTNO JOB
-----
         10 Clerk (Senior)
         20 Bookkeeper
         30 Analyst (Senior)

```

3 rows selected.

12.4.1.4.1 Sparse Collections and SQL%BULK_EXCEPTIONS

If the `FORALL` statement bounds clause references a sparse collection, then to find the collection element that caused a DML statement to fail, you must step through the elements one by one until you find the element whose index is `SQL%BULK_EXCEPTIONS(i).ERROR_INDEX`. Then, if the `FORALL` statement uses the `VALUES OF` clause to reference a collection of pointers into another collection, you must find the element of the other collection whose index is `SQL%BULK_EXCEPTIONS(i).ERROR_INDEX`.

12.4.1.5 Getting Number of Rows Affected by FORALL Statement

After a `FORALL` statement completes, you can get the number of rows that each DML statement affected from the implicit cursor attribute `SQL%BULK_ROWCOUNT`.

To get the total number of rows affected by the `FORALL` statement, use the implicit cursor attribute `SQL%ROWCOUNT`, described in "[SQL%ROWCOUNT Attribute: How Many Rows Were Affected?](#)".

`SQL%BULK_ROWCOUNT` is like an associative array whose *i*th element is the number of rows affected by the *i*th DML statement in the most recently completed `FORALL` statement. The data type of the element is `INTEGER`.

Note:

If a server is Oracle Database 12c or later and its client is Oracle Database 11g release 2 or earlier (or the reverse), then the maximum number that `SQL%BULK_ROWCOUNT` returns is 4,294,967,295.

Example 12-14 uses `SQL%BULK_ROWCOUNT` to show how many rows each `DELETE` statement in the `FORALL` statement deleted and `SQL%ROWCOUNT` to show the total number of rows deleted.

Example 12-15 uses `SQL%BULK_ROWCOUNT` to show how many rows each `INSERT SELECT` construct in the `FORALL` statement inserted and `SQL%ROWCOUNT` to show the total number of rows inserted.

Example 12-14 Showing Number of Rows Affected by Each DELETE in FORALL

```
DROP TABLE emp_temp;
CREATE TABLE emp_temp AS SELECT * FROM employees;

DECLARE
  TYPE NumList IS TABLE OF NUMBER;
  depts NumList := NumList(30, 50, 60);
BEGIN
  FORALL j IN depts.FIRST..depts.LAST
    DELETE FROM emp_temp WHERE department_id = depts(j);

  FOR i IN depts.FIRST..depts.LAST LOOP
    DBMS_OUTPUT.PUT_LINE (
      'Statement #' || i || ' deleted ' ||
      SQL%BULK_ROWCOUNT(i) || ' rows.'
    );
  END LOOP;

  DBMS_OUTPUT.PUT_LINE('Total rows deleted: ' || SQL%ROWCOUNT);
END;
/
```

Result:

```
Statement #1 deleted 6 rows.
Statement #2 deleted 45 rows.
```

Statement #3 deleted 5 rows.
Total rows deleted: 56

Example 12-15 Showing Number of Rows Affected by Each INSERT SELECT in FORALL

```
DROP TABLE emp_by_dept;
CREATE TABLE emp_by_dept AS
  SELECT employee_id, department_id
  FROM employees
  WHERE 1 = 0;

DECLARE
  TYPE dept_tab IS TABLE OF departments.department_id%TYPE;
  deptnums dept_tab;
BEGIN
  SELECT department_id BULK COLLECT INTO deptnums FROM departments;

  FORALL i IN 1..deptnums.COUNT
    INSERT INTO emp_by_dept (employee_id, department_id)
      SELECT employee_id, department_id
      FROM employees
      WHERE department_id = deptnums(i)
      ORDER BY department_id, employee_id;

  FOR i IN 1..deptnums.COUNT LOOP
    -- Count how many rows were inserted for each department; that is,
    -- how many employees are in each department.
    DBMS_OUTPUT.PUT_LINE (
      'Dept ' ||deptnums(i)||': inserted ' ||
      SQL%BULK_ROWCOUNT(i)||' records'
    );
  END LOOP;
  DBMS_OUTPUT.PUT_LINE('Total records inserted: ' || SQL%ROWCOUNT);
END;
/
```

Result:

```
Dept 10: inserted 1 records
Dept 20: inserted 2 records
Dept 30: inserted 6 records
Dept 40: inserted 1 records
Dept 50: inserted 45 records
Dept 60: inserted 5 records
Dept 70: inserted 1 records
Dept 80: inserted 34 records
Dept 90: inserted 3 records
Dept 100: inserted 6 records
Dept 110: inserted 2 records
Dept 120: inserted 0 records
Dept 130: inserted 0 records
Dept 140: inserted 0 records
Dept 150: inserted 0 records
Dept 160: inserted 0 records
Dept 170: inserted 0 records
Dept 180: inserted 0 records
Dept 190: inserted 0 records
Dept 200: inserted 0 records
Dept 210: inserted 0 records
Dept 220: inserted 0 records
```

```
Dept 230: inserted 0 records
Dept 240: inserted 0 records
Dept 250: inserted 0 records
Dept 260: inserted 0 records
Dept 270: inserted 0 records
Dept 280: inserted 0 records
Total records inserted: 106
```

12.4.2 BULK COLLECT Clause

The `BULK COLLECT` clause, a feature of bulk SQL, returns results from SQL to PL/SQL in batches rather than one at a time.

The `BULK COLLECT` clause can appear in:

- `SELECT INTO` statement
- `FETCH` statement
- `RETURNING INTO` clause of:
 - `DELETE` statement
 - `INSERT` statement
 - `UPDATE` statement
 - `EXECUTE IMMEDIATE` statement

With the `BULK COLLECT` clause, each of the preceding statements retrieves an entire result set and stores it in one or more collection variables in a single operation (which is more efficient than using a loop statement to retrieve one result row at a time).

Note:

PL/SQL processes the `BULK COLLECT` clause similar to the way it processes a `FETCH` statement inside a `LOOP` statement. PL/SQL does not raise an exception when a statement with a `BULK COLLECT` clause returns no rows. You must check the target collections for emptiness, as in [Example 12-22](#).

Topics

- [SELECT INTO Statement with BULK COLLECT Clause](#)
- [FETCH Statement with BULK COLLECT Clause](#)
- [RETURNING INTO Clause with BULK COLLECT Clause](#)

12.4.2.1 SELECT INTO Statement with BULK COLLECT Clause

The `SELECT INTO` statement with the `BULK COLLECT` clause (also called the `SELECT BULK COLLECT INTO` statement) selects an entire result set into one or more collection variables.

For more information, see "[SELECT INTO Statement](#)".

▲ Caution:

The `SELECT BULK COLLECT INTO` statement is vulnerable to aliasing, which can cause unexpected results. For details, see "[SELECT BULK COLLECT INTO Statements and Aliasing](#)".

[Example 12-16](#) uses a `SELECT BULK COLLECT INTO` statement to select two database columns into two collections (nested tables).

[Example 12-17](#) uses a `SELECT BULK COLLECT INTO` statement to select a result set into a nested table of records.

Topics

- [SELECT BULK COLLECT INTO Statements and Aliasing](#)
- [Row Limits for SELECT BULK COLLECT INTO Statements](#)
- [Guidelines for Looping Through Collections](#)

Example 12-16 Bulk-Selecting Two Database Columns into Two Nested Tables

```

DECLARE
    TYPE NumTab IS TABLE OF employees.employee_id%TYPE;
    TYPE NameTab IS TABLE OF employees.last_name%TYPE;

    enums NumTab;
    names NameTab;

    PROCEDURE print_first_n (n POSITIVE) IS
    BEGIN
        IF enums.COUNT = 0 THEN
            DBMS_OUTPUT.PUT_LINE ('Collections are empty.');
```

```

        ELSE
            DBMS_OUTPUT.PUT_LINE ('First ' || n || ' employees:');

            FOR i IN 1 .. n LOOP
                DBMS_OUTPUT.PUT_LINE (
                    ' Employee #' || enums(i) || ': ' || names(i));
            END LOOP;
        END IF;
    END;

BEGIN
    SELECT employee_id, last_name
    BULK COLLECT INTO enums, names
    FROM employees
    ORDER BY employee_id;

    print_first_n(3);
    print_first_n(6);
END;
/
```

Result:

```

First 3 employees:
Employee #100: King
Employee #101: Kochhar
```



```

Employee #102: De Haan
First 6 employees:
Employee #100: King
Employee #101: Kochhar
Employee #102: De Haan
Employee #103: Hunold
Employee #104: Ernst
Employee #105: Austin

```

Example 12-17 Bulk-Selecting into Nested Table of Records

```

DECLARE
  CURSOR c1 IS
    SELECT first_name, last_name, hire_date
    FROM employees;

  TYPE NameSet IS TABLE OF c1%ROWTYPE;

  stock_managers NameSet; -- nested table of records

BEGIN
  -- Assign values to nested table of records:

  SELECT first_name, last_name, hire_date
     BULK COLLECT INTO stock_managers
  FROM employees
  WHERE job_id = 'ST_MAN'
  ORDER BY hire_date;

  -- Print nested table of records:

  FOR i IN stock_managers.FIRST .. stock_managers.LAST LOOP
    DBMS_OUTPUT.PUT_LINE (
      stock_managers(i).hire_date || ' ' ||
      stock_managers(i).last_name || ', ' ||
      stock_managers(i).first_name
    );
  END LOOP;END;
/

```

Result:

```

01-MAY-03 Kaufling, Payam
18-JUL-04 Weiss, Matthew
10-APR-05 Fripp, Adam
10-OCT-05 Vollman, Shanta
16-NOV-07 Mourgos, Kevin

```

12.4.2.1.1 SELECT BULK COLLECT INTO Statements and Aliasing

In a statement of the form

```
SELECT column BULK COLLECT INTO collection FROM table ...
```

column and *collection* are analogous to IN NOCOPY and OUT NOCOPY subprogram parameters, respectively, and PL/SQL passes them by reference. As with subprogram parameters that are passed by reference, aliasing can cause unexpected results.

**See Also:**

"Subprogram Parameter Aliasing with Parameters Passed by Reference"

In [Example 12-18](#), the intention is to select specific values from a collection, `numbers1`, and then store them in the same collection. The unexpected result is that all elements of `numbers1` are deleted. For workarounds, see [Example 12-19](#) and [Example 12-20](#).

[Example 12-19](#) uses a cursor to achieve the result intended by [Example 12-18](#).

[Example 12-20](#) selects specific values from a collection, `numbers1`, and then stores them in a different collection, `numbers2`. [Example 12-20](#) runs faster than [Example 12-19](#).

Example 12-18 SELECT BULK COLLECT INTO Statement with Unexpected Results

```

CREATE OR REPLACE TYPE numbers_type IS
  TABLE OF INTEGER
/
CREATE OR REPLACE PROCEDURE p (i IN INTEGER) AUTHID DEFINER IS
  numbers1 numbers_type := numbers_type(1,2,3,4,5);
BEGIN
  DBMS_OUTPUT.PUT_LINE('Before SELECT statement');
  DBMS_OUTPUT.PUT_LINE('numbers1.COUNT() = ' || numbers1.COUNT());

  FOR j IN 1..numbers1.COUNT() LOOP
    DBMS_OUTPUT.PUT_LINE('numbers1(' || j || ') = ' || numbers1(j));
  END LOOP;

  --Self-selecting BULK COLLECT INTO clause:

  SELECT a.COLUMN_VALUE
  BULK COLLECT INTO numbers1
  FROM TABLE(numbers1) a
  WHERE a.COLUMN_VALUE > p.i
  ORDER BY a.COLUMN_VALUE;

  DBMS_OUTPUT.PUT_LINE('After SELECT statement');
  DBMS_OUTPUT.PUT_LINE('numbers1.COUNT() = ' || numbers1.COUNT());
END p;
/

```

Invoke p:

```

BEGIN
  p(2);
END;
/

```

Result:

```

Before SELECT statement
numbers1.COUNT() = 5
numbers1(1) = 1
numbers1(2) = 2
numbers1(3) = 3
numbers1(4) = 4
numbers1(5) = 5
After SELECT statement

```

```
numbers1.COUNT() = 0
```

PL/SQL procedure successfully completed.

Invoke p:

```
BEGIN
  p(10);
END;
/
```

Result:

Before SELECT statement

```
numbers1.COUNT() = 5
```

```
numbers1(1) = 1
```

```
numbers1(2) = 2
```

```
numbers1(3) = 3
```

```
numbers1(4) = 4
```

```
numbers1(5) = 5
```

After SELECT statement

```
numbers1.COUNT() = 0
```

Example 12-19 Cursor Workaround for Example 12-18

```
CREATE OR REPLACE TYPE numbers_type IS
  TABLE OF INTEGER
/
CREATE OR REPLACE PROCEDURE p (i IN INTEGER) AUTHID DEFINER IS
  numbers1 numbers_type := numbers_type(1,2,3,4,5);

  CURSOR c IS
    SELECT a.COLUMN_VALUE
    FROM TABLE(numbers1) a
    WHERE a.COLUMN_VALUE > p.i
    ORDER BY a.COLUMN_VALUE;
BEGIN
  DBMS_OUTPUT.PUT_LINE('Before FETCH statement');
  DBMS_OUTPUT.PUT_LINE('numbers1.COUNT() = ' || numbers1.COUNT());

  FOR j IN 1..numbers1.COUNT() LOOP
    DBMS_OUTPUT.PUT_LINE('numbers1(' || j || ') = ' || numbers1(j));
  END LOOP;

  OPEN c;
  FETCH c BULK COLLECT INTO numbers1;
  CLOSE c;

  DBMS_OUTPUT.PUT_LINE('After FETCH statement');
  DBMS_OUTPUT.PUT_LINE('numbers1.COUNT() = ' || numbers1.COUNT());

  IF numbers1.COUNT() > 0 THEN
    FOR j IN 1..numbers1.COUNT() LOOP
      DBMS_OUTPUT.PUT_LINE('numbers1(' || j || ') = ' || numbers1(j));
    END LOOP;
  END IF;
END p;
/
```

Invoke p:

```
BEGIN
  p(2);
END;
/
```

Result:

```
Before FETCH statement
numbers1.COUNT() = 5
numbers1(1) = 1
numbers1(2) = 2
numbers1(3) = 3
numbers1(4) = 4
numbers1(5) = 5
After FETCH statement
numbers1.COUNT() = 3
numbers1(1) = 3
numbers1(2) = 4
numbers1(3) = 5
```

Invoke p:

```
BEGIN
  p(10);
END;
/
```

Result:

```
Before FETCH statement
numbers1.COUNT() = 5
numbers1(1) = 1
numbers1(2) = 2
numbers1(3) = 3
numbers1(4) = 4
numbers1(5) = 5
After FETCH statement
numbers1.COUNT() = 0
```

Example 12-20 Second Collection Workaround for [Example 12-18](#)

```
CREATE OR REPLACE TYPE numbers_type IS
  TABLE OF INTEGER
/
CREATE OR REPLACE PROCEDURE p (i IN INTEGER) AUTHID DEFINER IS
  numbers1 numbers_type := numbers_type(1,2,3,4,5);
  numbers2 numbers_type := numbers_type(0,0,0,0,0);
BEGIN
  DBMS_OUTPUT.PUT_LINE('Before SELECT statement');

  DBMS_OUTPUT.PUT_LINE('numbers1.COUNT() = ' || numbers1.COUNT());

  FOR j IN 1..numbers1.COUNT() LOOP
    DBMS_OUTPUT.PUT_LINE('numbers1(' || j || ') = ' || numbers1(j));
  END LOOP;

  DBMS_OUTPUT.PUT_LINE('numbers2.COUNT() = ' || numbers2.COUNT());

  FOR j IN 1..numbers2.COUNT() LOOP
    DBMS_OUTPUT.PUT_LINE('numbers2(' || j || ') = ' || numbers2(j));
  END LOOP;
```

```
SELECT a.COLUMN_VALUE
BULK COLLECT INTO numbers2      -- numbers2 appears here
FROM TABLE(numbers1) a        -- numbers1 appears here
WHERE a.COLUMN_VALUE > p.i
ORDER BY a.COLUMN_VALUE;

DBMS_OUTPUT.PUT_LINE('After SELECT statement');
DBMS_OUTPUT.PUT_LINE('numbers1.COUNT() = ' || numbers1.COUNT());

IF numbers1.COUNT() > 0 THEN
  FOR j IN 1..numbers1.COUNT() LOOP
    DBMS_OUTPUT.PUT_LINE('numbers1(' || j || ') = ' || numbers1(j));
  END LOOP;
END IF;

DBMS_OUTPUT.PUT_LINE('numbers2.COUNT() = ' || numbers2.COUNT());

IF numbers2.COUNT() > 0 THEN
  FOR j IN 1..numbers2.COUNT() LOOP
    DBMS_OUTPUT.PUT_LINE('numbers2(' || j || ') = ' || numbers2(j));
  END LOOP;
END IF;
END p;
/
```

Invoke p:

```
BEGIN
  p(2);
END;
/
```

Result:

Before SELECT statement

numbers1.COUNT() = 5

```
numbers1(1) = 1
numbers1(2) = 2
numbers1(3) = 3
numbers1(4) = 4
numbers1(5) = 5
```

numbers2.COUNT() = 5

```
numbers2(1) = 0
numbers2(2) = 0
numbers2(3) = 0
numbers2(4) = 0
numbers2(5) = 0
```

After SELECT statement

numbers1.COUNT() = 5

```
numbers1(1) = 1
numbers1(2) = 2
numbers1(3) = 3
numbers1(4) = 4
numbers1(5) = 5
```

numbers2.COUNT() = 3

```
numbers2(1) = 3
numbers2(2) = 4
numbers2(3) = 5
```

PL/SQL procedure successfully completed.

Invoke p:

```
BEGIN
  p(10);
END;
/
```

Result:

Before SELECT statement

```
numbers1.COUNT() = 5
```

```
numbers1(1) = 1
```

```
numbers1(2) = 2
```

```
numbers1(3) = 3
```

```
numbers1(4) = 4
```

```
numbers1(5) = 5
```

```
numbers2.COUNT() = 5
```

```
numbers2(1) = 0
```

```
numbers2(2) = 0
```

```
numbers2(3) = 0
```

```
numbers2(4) = 0
```

```
numbers2(5) = 0
```

After SELECT statement

```
numbers1.COUNT() = 5
```

```
numbers1(1) = 1
```

```
numbers1(2) = 2
```

```
numbers1(3) = 3
```

```
numbers1(4) = 4
```

```
numbers1(5) = 5
```

```
numbers2.COUNT() = 0
```

12.4.2.1.2 Row Limits for SELECT BULK COLLECT INTO Statements

A `SELECT BULK COLLECT INTO` statement that returns a large number of rows produces a large collection. To limit the number of rows and the collection size, use one of these:

- `ROWNUM` pseudocolumn (described in *Oracle Database SQL Language Reference*)
- `SAMPLE` clause (described in *Oracle Database SQL Language Reference*)
- `FETCH FIRST` clause (described in *Oracle Database SQL Language Reference*)

[Example 12-21](#) shows several ways to limit the number of rows that a `SELECT BULK COLLECT INTO` statement returns.

Example 12-21 Limiting Bulk Selection with ROWNUM, SAMPLE, and FETCH FIRST

```
DECLARE
  TYPE Sallist IS TABLE OF employees.salary%TYPE;
  sals Sallist;
BEGIN
  SELECT salary BULK COLLECT INTO sals FROM employees
     WHERE ROWNUM <= 50;

  SELECT salary BULK COLLECT INTO sals FROM employees
     SAMPLE (10);

  SELECT salary BULK COLLECT INTO sals FROM employees
     FETCH FIRST 50 ROWS ONLY;
END;
/
```

12.4.2.1.3 Guidelines for Looping Through Collections

When a result set is stored in a collection, it is easy to loop through the rows and refer to different columns. This technique can be very fast, but also very memory-intensive. If you use it often:

- To loop once through the result set, use a cursor `FOR LOOP` (see "[Processing Query Result Sets With Cursor FOR LOOP Statements](#)").

This technique avoids the memory overhead of storing a copy of the result set.

- Instead of looping through the result set to search for certain values or filter the results into a smaller set, do the searching or filtering in the query of the `SELECT INTO` statement.

For example, in simple queries, use `WHERE` clauses; in queries that compare multiple result sets, use set operators such as `INTERSECT` and `MINUS`. For information about set operators, see *Oracle Database SQL Language Reference*.

- Instead of looping through the result set and running another query for each result row, use a subquery in the query of the `SELECT INTO` statement (see "[Processing Query Result Sets with Subqueries](#)").
- Instead of looping through the result set and running another DML statement for each result row, use the `FORALL` statement (see "[FORALL Statement](#)").

12.4.2.2 FETCH Statement with BULK COLLECT Clause

The `FETCH` statement with the `BULK COLLECT` clause (also called the `FETCH BULK COLLECT` statement) fetches an entire result set into one or more collection variables.

For more information, see "[FETCH Statement](#)".

[Example 12-22](#) uses a `FETCH BULK COLLECT` statement to fetch an entire result set into two collections (nested tables).

[Example 12-23](#) uses a `FETCH BULK COLLECT` statement to fetch a result set into a collection (nested table) of records.

Example 12-22 Bulk-Fetching into Two Nested Tables

```
DECLARE
  NameList IS TABLE OF employees.last_name%TYPE;
  SalList IS TABLE OF employees.salary%TYPE;

  CURSOR c1 IS
    SELECT last_name, salary
    FROM employees
    WHERE salary > 10000
    ORDER BY last_name;

  names NameList;
  sals SalList;

  TYPE RecList IS TABLE OF c1%ROWTYPE;
  recs RecList;

  v_limit PLS_INTEGER := 10;
```

```
PROCEDURE print_results IS
BEGIN
  -- Check if collections are empty:

  IF names IS NULL OR names.COUNT = 0 THEN
    DBMS_OUTPUT.PUT_LINE('No results!');
  ELSE
    DBMS_OUTPUT.PUT_LINE('Result: ');
    FOR i IN names.FIRST .. names.LAST
    LOOP
      DBMS_OUTPUT.PUT_LINE(' Employee ' || names(i) || ': $' || sals(i));
    END LOOP;
  END IF;
END;

BEGIN
  DBMS_OUTPUT.PUT_LINE ('--- Processing all results simultaneously ---');
  OPEN c1;
  FETCH c1 BULK COLLECT INTO names, sals;
  CLOSE c1;
  print_results();
  DBMS_OUTPUT.PUT_LINE ('--- Processing ' || v_limit || ' rows at a time ---');
  OPEN c1;
  LOOP
    FETCH c1 BULK COLLECT INTO names, sals LIMIT v_limit;
    EXIT WHEN names.COUNT = 0;
    print_results();
  END LOOP;
  CLOSE c1;
  DBMS_OUTPUT.PUT_LINE ('--- Fetching records rather than columns ---');
  OPEN c1;
  FETCH c1 BULK COLLECT INTO recs;
  FOR i IN recs.FIRST .. recs.LAST
  LOOP
    -- Now all columns from result set come from one record
    DBMS_OUTPUT.PUT_LINE (
      ' Employee ' || recs(i).last_name || ': $' || recs(i).salary
    );
  END LOOP;
END;
/
```

Result:

```
--- Processing all results simultaneously ---
Result:
Employee Abel: $11000
Employee Cambraut: $11000
Employee De Haan: $17000
Employee Errazuriz: $12000
Employee Fripp: $10418.1
Employee Greenberg: $12008
Employee Hartstein: $13000
Employee Higgins: $12008
Employee Kaufling: $10036.95
Employee King: $24000
Employee Kochhar: $17000
Employee Ozer: $11500
Employee Partners: $13500
Employee Raphaely: $11000
Employee Russell: $14000
```



```
Employee Vishney: $10500
Employee Weiss: $10418.1
Employee Zlotkey: $10500
--- Processing 10 rows at a time ---
Result:
Employee Abel: $11000
Employee Cambrault: $11000
Employee De Haan: $17000
Employee Errazuriz: $12000
Employee Fripp: $10418.1
Employee Greenberg: $12008
Employee Hartstein: $13000
Employee Higgins: $12008
Employee Kaufling: $10036.95
Employee King: $24000
Result:
Employee Kochhar: $17000
Employee Ozer: $11500
Employee Partners: $13500
Employee Raphaely: $11000
Employee Russell: $14000
Employee Vishney: $10500
Employee Weiss: $10418.1
Employee Zlotkey: $10500
--- Fetching records rather than columns ---
Employee Abel: $11000
Employee Cambrault: $11000
Employee De Haan: $17000
Employee Errazuriz: $12000
Employee Fripp: $10418.1
Employee Greenberg: $12008
Employee Hartstein: $13000
Employee Higgins: $12008
Employee Kaufling: $10036.95
Employee King: $24000
Employee Kochhar: $17000
Employee Ozer: $11500
Employee Partners: $13500
Employee Raphaely: $11000
Employee Russell: $14000
Employee Vishney: $10500
Employee Weiss: $10418.1
Employee Zlotkey: $10500
```

Example 12-23 Bulk-Fetching into Nested Table of Records

```
DECLARE
  CURSOR c1 IS
    SELECT first_name, last_name, hire_date
    FROM employees;

  TYPE NameSet IS TABLE OF c1%ROWTYPE;
  stock_managers NameSet; -- nested table of records

  TYPE cursor_var_type is REF CURSOR;
  cv cursor_var_type;

BEGIN
  -- Assign values to nested table of records:

  OPEN cv FOR
```

```

SELECT first_name, last_name, hire_date
FROM employees
WHERE job_id = 'ST_MAN'
ORDER BY hire_date;

FETCH cv BULK COLLECT INTO stock_managers;
CLOSE cv;

-- Print nested table of records:

FOR i IN stock_managers.FIRST .. stock_managers.LAST LOOP
    DBMS_OUTPUT.PUT_LINE (
        stock_managers(i).hire_date || ' ' ||
        stock_managers(i).last_name || ', ' ||
        stock_managers(i).first_name
    );
END LOOP;END;
/

```

Result:

```

01-MAY-03 Kaufling, Payam
18-JUL-04 Weiss, Matthew
10-APR-05 Fripp, Adam
10-OCT-05 Vollman, Shanta
16-NOV-07 Mourgos, Kevin

```

12.4.2.2.1 Row Limits for FETCH BULK COLLECT Statements

A `FETCH BULK COLLECT` statement that returns a large number of rows produces a large collection. To limit the number of rows and the collection size, use the `LIMIT` clause.

In [Example 12-24](#), with each iteration of the `LOOP` statement, the `FETCH` statement fetches ten rows (or fewer) into associative array `empids` (overwriting the previous values). Note the exit condition for the `LOOP` statement.

Example 12-24 Limiting Bulk FETCH with LIMIT

```

DECLARE
    TYPE numtab IS TABLE OF NUMBER INDEX BY PLS_INTEGER;

    CURSOR c1 IS
        SELECT employee_id
        FROM employees
        WHERE department_id = 80
        ORDER BY employee_id;

    empids numtab;
BEGIN
    OPEN c1;
    LOOP -- Fetch 10 rows or fewer in each iteration
        FETCH c1 BULK COLLECT INTO empids LIMIT 10;
        DBMS_OUTPUT.PUT_LINE ('----- Results from One Bulk Fetch -----');
        FOR i IN 1..empids.COUNT LOOP
            DBMS_OUTPUT.PUT_LINE ('Employee Id: ' || empids(i));
        END LOOP;
        EXIT WHEN c1%NOTFOUND;
    END LOOP;
    CLOSE c1;
END;
/

```

Result:

```
----- Results from One Bulk Fetch -----
Employee Id: 145
Employee Id: 146
Employee Id: 147
Employee Id: 148
Employee Id: 149
Employee Id: 150
Employee Id: 151
Employee Id: 152
Employee Id: 153
Employee Id: 154
----- Results from One Bulk Fetch -----
Employee Id: 155
Employee Id: 156
Employee Id: 157
Employee Id: 158
Employee Id: 159
Employee Id: 160
Employee Id: 161
Employee Id: 162
Employee Id: 163
Employee Id: 164
----- Results from One Bulk Fetch -----
Employee Id: 165
Employee Id: 166
Employee Id: 167
Employee Id: 168
Employee Id: 169
Employee Id: 170
Employee Id: 171
Employee Id: 172
Employee Id: 173
Employee Id: 174
----- Results from One Bulk Fetch -----
Employee Id: 175
Employee Id: 176
Employee Id: 177
Employee Id: 179
```

12.4.2.3 RETURNING INTO Clause with BULK COLLECT Clause

The RETURNING INTO clause with the BULK COLLECT clause (also called the RETURNING BULK COLLECT INTO clause) can appear in an INSERT, UPDATE, DELETE, or EXECUTE IMMEDIATE statement. With the RETURNING BULK COLLECT INTO clause, the statement stores its result set in one or more collections.

For more information, see ["RETURNING INTO Clause"](#).

Example 12-25 uses a DELETE statement with the RETURNING BULK COLLECT INTO clause to delete rows from a table and return them in two collections (nested tables).

Example 12-25 Returning Deleted Rows in Two Nested Tables

```
DROP TABLE emp_temp;
CREATE TABLE emp_temp AS
SELECT * FROM employees
ORDER BY employee_id;

DECLARE
```

```

TYPE NumList IS TABLE OF employees.employee_id%TYPE;
enums NumList;
TYPE NameList IS TABLE OF employees.last_name%TYPE;
names NameList;
BEGIN
  DELETE FROM emp_temp
  WHERE department_id = 30
  RETURNING employee_id, last_name
  BULK COLLECT INTO enums, names;

  DBMS_OUTPUT.PUT_LINE ('Deleted ' || SQL%ROWCOUNT || ' rows:');
  FOR i IN enums.FIRST .. enums.LAST
  LOOP
    DBMS_OUTPUT.PUT_LINE ('Employee #' || enums(i) || ': ' || names(i));
  END LOOP;
END;
/

```

Result:

```

Deleted 6 rows:
Employee #114: Raphaely
Employee #115: Khoo
Employee #116: Baida
Employee #117: Tobias
Employee #118: Himuro
Employee #119: Colmenares

```

12.4.3 Using FORALL Statement and BULK COLLECT Clause Together

In a `FORALL` statement, the DML statement can have a `RETURNING BULK COLLECT INTO` clause. For each iteration of the `FORALL` statement, the DML statement stores the specified values in the specified collections—without overwriting the previous values, as the same DML statement would do in a `FOR LOOP` statement.

In [Example 12-26](#), the `FORALL` statement runs a `DELETE` statement that has a `RETURNING BULK COLLECT INTO` clause. For each iteration of the `FORALL` statement, the `DELETE` statement stores the `employee_id` and `department_id` values of the deleted row in the collections `e_ids` and `d_ids`, respectively.

[Example 12-27](#) is like [Example 12-26](#) except that it uses a `FOR LOOP` statement instead of a `FORALL` statement.

Example 12-26 DELETE with RETURN BULK COLLECT INTO in FORALL Statement

```

DROP TABLE emp_temp;
CREATE TABLE emp_temp AS
SELECT * FROM employees
ORDER BY employee_id, department_id;

DECLARE
  TYPE NumList IS TABLE OF NUMBER;
  depts NumList := NumList(10,20,30);

  TYPE enum_t IS TABLE OF employees.employee_id%TYPE;
  e_ids enum_t;

  TYPE dept_t IS TABLE OF employees.department_id%TYPE;
  d_ids dept_t;

```

```

BEGIN
  FORALL j IN depts.FIRST..depts.LAST
    DELETE FROM emp_temp
    WHERE department_id = depts(j)
    RETURNING employee_id, department_id
    BULK COLLECT INTO e_ids, d_ids;

  DBMS_OUTPUT.PUT_LINE ('Deleted ' || SQL%ROWCOUNT || ' rows:');

  FOR i IN e_ids.FIRST .. e_ids.LAST
  LOOP
    DBMS_OUTPUT.PUT_LINE (
      'Employee #' || e_ids(i) || ' from dept #' || d_ids(i)
    );
  END LOOP;
END;
/

```

Result:

```

Deleted 9 rows:
Employee #200 from dept #10
Employee #201 from dept #20
Employee #202 from dept #20
Employee #114 from dept #30
Employee #115 from dept #30
Employee #116 from dept #30
Employee #117 from dept #30
Employee #118 from dept #30
Employee #119 from dept #30

```

Example 12-27 DELETE with RETURN BULK COLLECT INTO in FOR LOOP Statement

```

DECLARE
  TYPE NumList IS TABLE OF NUMBER;
  depts NumList := NumList(10,20,30);

  TYPE enum_t IS TABLE OF employees.employee_id%TYPE;
  e_ids enum_t;

  TYPE dept_t IS TABLE OF employees.department_id%TYPE;
  d_ids dept_t;

BEGIN
  FOR j IN depts.FIRST..depts.LAST LOOP
    DELETE FROM emp_temp
    WHERE department_id = depts(j)
    RETURNING employee_id, department_id
    BULK COLLECT INTO e_ids, d_ids;
  END LOOP;

  DBMS_OUTPUT.PUT_LINE ('Deleted ' || SQL%ROWCOUNT || ' rows:');

  FOR i IN e_ids.FIRST .. e_ids.LAST
  LOOP
    DBMS_OUTPUT.PUT_LINE (
      'Employee #' || e_ids(i) || ' from dept #' || d_ids(i)
    );
  END LOOP;

```

```
END;
/
```

Result:

```
Deleted 6 rows:
Employee #114 from dept #30
Employee #115 from dept #30
Employee #116 from dept #30
Employee #117 from dept #30
Employee #118 from dept #30
Employee #119 from dept #30
```

12.4.4 Client Bulk-Binding of Host Arrays

Client programs (such as OCI and Pro*C programs) can use PL/SQL anonymous blocks to bulk-bind input and output host arrays. This is the most efficient way to pass collections to and from the database server.

In the client program, declare and assign values to the host variables to be referenced in the anonymous block. In the anonymous block, prefix each host variable name with a colon (:) to distinguish it from a PL/SQL collection variable name. When the client program runs, the database server runs the PL/SQL anonymous block.

In [Example 12-28](#), the anonymous block uses a `FORALL` statement to bulk-bind a host input array. In the `FORALL` statement, the `DELETE` statement refers to four host variables: scalars `lower`, `upper`, and `emp_id` and array `depts`.

Example 12-28 Anonymous Block Bulk-Binds Input Host Array

```
BEGIN
  FORALL i IN :lower..:upper
    DELETE FROM employees
      WHERE department_id = :depts(i);
END;
/
```

12.5 Chaining Pipelined Table Functions for Multiple Transformations

Chaining pipelined table functions is an efficient way to perform multiple transformations on data.

Note:

You cannot run a pipelined table function over a database link. The reason is that the return type of a pipelined table function is a SQL user-defined type, which can be used only in a single database (as explained in *Oracle Database Object-Relational Developer's Guide*). Although the return type of a pipelined table function might appear to be a PL/SQL type, the database actually converts that PL/SQL type to a corresponding SQL user-defined type.

Topics

- [Overview of Table Functions](#)
- [Creating Pipelined Table Functions](#)
- [Pipelined Table Functions as Transformation Functions](#)
- [Chaining Pipelined Table Functions](#)
- [Fetching from Results of Pipelined Table Functions](#)
- [Passing CURSOR Expressions to Pipelined Table Functions](#)
- [DML Statements on Pipelined Table Function Results](#)
- [NO_DATA_NEEDED Exception](#)

12.5.1 Overview of Table Functions

A **table function** is a user-defined PL/SQL function that returns a collection of rows (an associative array, nested table or varray).

You can select from this collection as if it were a database table by invoking the table function inside the `TABLE` clause in a `SELECT` statement. The `TABLE` operator is optional.

For example:

```
SELECT * FROM TABLE(table_function_name(parameter_list))
```

Alternatively, the same query can be written without the `TABLE` operator as follow:

```
SELECT * FROM table_function_name(parameter_list)
```

A table function can take a collection of rows as input (that is, it can have an input parameter that is a nested table, varray, or cursor variable). Therefore, output from table function `tf1` can be input to table function `tf2`, and output from `tf2` can be input to table function `tf3`, and so on.

To improve the performance of a table function, you can:

- Enable the function for parallel execution, with the `PARALLEL_ENABLE` option.
Functions enabled for parallel execution can run concurrently.
- Stream the function results directly to the next process, with Oracle Streams.
Streaming eliminates intermediate staging between processes.
- Pipeline the function results, with the `PIPELINED` option.

A **pipelined table function** returns a row to its invoker immediately after processing that row and continues to process rows. Response time improves because the entire collection need not be constructed and returned to the server before the query can return a single result row. (Also, the function needs less memory, because the object cache need not materialize the entire collection.)

 **Caution:**

A pipelined table function always references the current state of the data. If the data in the collection changes after the cursor opens for the collection, then the cursor reflects the changes. PL/SQL variables are private to a session and are not transactional. Therefore, read consistency, well known for its applicability to table data, does not apply to PL/SQL collection variables.

 **See Also:**

- [Chaining Pipelined Table Functions](#)
- *Oracle Database SQL Language Reference* for more information about the `TABLE` clause of the `SELECT` statement
- *Oracle Database Data Cartridge Developer's Guide* for information about using pipelined and parallel table functions

12.5.2 Creating Pipelined Table Functions

A pipelined table function must be either a standalone function or a package function.

PIPELINED Option (Required)

For a standalone function, specify the `PIPELINED` option in the `CREATE FUNCTION` statement (for syntax, see "[CREATE FUNCTION Statement](#)"). For a package function, specify the `PIPELINED` option in both the function declaration and function definition (for syntax, see "[Function Declaration and Definition](#)").

PARALLEL_ENABLE Option (Recommended)

To improve its performance, enable the pipelined table function for parallel execution by specifying the `PARALLEL_ENABLE` option.

AUTONOMOUS_TRANSACTION Pragma

If the pipelined table function runs DML statements, then make it autonomous, with the `AUTONOMOUS_TRANSACTION` pragma (described in "[AUTONOMOUS_TRANSACTION Pragma](#)"). Then, during parallel execution, each instance of the function creates an independent transaction.

DETERMINISTIC Option (Recommended)

Multiple invocations of a pipelined table function, in either the same query or separate queries, cause multiple executions of the underlying implementation. If the function is deterministic, specify the `DETERMINISTIC` option, described in "[DETERMINISTIC Clause](#)".

Parameters

Typically, a pipelined table function has one or more cursor variable parameters. For information about cursor variables as function parameters, see "[Cursor Variables as Subprogram Parameters](#)".

 **See Also:**

- "[Cursor Variables](#)" for general information about cursor variables
- "[Subprogram Parameters](#)" for general information about subprogram parameters

RETURN Data Type

The data type of the value that a pipelined table function returns must be a collection type defined either at schema level or inside a package (therefore, it cannot be an associative array type). The elements of the collection type must be SQL data types, not data types supported only by PL/SQL (such as `PLS_INTEGER` and `BOOLEAN`). For information about collection types, see "[Collection Types](#)". For information about SQL data types, see *Oracle Database SQL Language Reference*.

You can use SQL data types `ANYTYPE`, `ANYDATA`, and `ANYDATASET` to dynamically encapsulate and access type descriptions, data instances, and sets of data instances of any other SQL type, including object and collection types. You can also use these types to create unnamed types, including anonymous collection types. For information about these types, see *Oracle Database PL/SQL Packages and Types Reference*.

PIPE ROW Statement

Inside a pipelined table function, use the `PIPE ROW` statement to return a collection element to the invoker without returning control to the invoker. See "[PIPE ROW Statement](#)" for its syntax and semantics.

RETURN Statement

As in every function, every execution path in a pipelined table function must lead to a `RETURN` statement, which returns control to the invoker. However, in a pipelined table function, a `RETURN` statement need not return a value to the invoker. See "[RETURN Statement](#)" for its syntax and semantics.

Example**Example 12-29 Creating and Invoking Pipelined Table Function**

This example creates a package that includes a pipelined table function, `f1`, and then selects from the collection of rows that `f1` returns.

```
CREATE OR REPLACE PACKAGE pkg1 AUTHID DEFINER AS
  TYPE numset_t IS TABLE OF NUMBER;
  FUNCTION f1(x NUMBER) RETURN numset_t PIPELINED;
END pkg1;
/
```

Create a pipelined table function `f1` that returns a collection of elements (1,2,3,... x).

```
CREATE OR REPLACE PACKAGE BODY pkg1 AS
  FUNCTION f1(x NUMBER) RETURN numset_t PIPELINED IS
  BEGIN
    FOR i IN 1..x LOOP
      PIPE ROW(i);
    
```

```

        END LOOP;
        RETURN;
    END f1;
END pkg1;

SELECT * FROM TABLE(pkg1.f1(5));

```

Result:

```

COLUMN_VALUE
-----
          1
          2
          3
          4
          5

```

5 rows selected.

```

SELECT * FROM pkg1.f1(2);

```

Result:

```

COLUMN_VALUE
-----
          1
          2

```

12.5.3 Pipelined Table Functions as Transformation Functions

A pipelined table function with a cursor variable parameter can serve as a transformation function. Using the cursor variable, the function fetches an input row. Using the `PIPE ROW` statement, the function pipes the transformed row or rows to the invoker. If the `FETCH` and `PIPE ROW` statements are inside a `LOOP` statement, the function can transform multiple input rows.

In [Example 12-30](#), the pipelined table function transforms each selected row of the `employees` table to two nested table rows, which it pipes to the `SELECT` statement that invokes it. The actual parameter that corresponds to the formal cursor variable parameter is a `CURSOR` expression; for information about these, see ["Passing CURSOR Expressions to Pipelined Table Functions"](#).

Example 12-30 Pipelined Table Function Transforms Each Row to Two Rows

```

CREATE OR REPLACE PACKAGE refcur_pkg AUTHID DEFINER IS
    TYPE refcur_t IS REF CURSOR RETURN employees%ROWTYPE;
    TYPE outrec_typ IS RECORD (
        var_num      NUMBER(6),
        var_char1   VARCHAR2(30),
        var_char2   VARCHAR2(30)
    );
    TYPE outrecset IS TABLE OF outrec_typ;
    FUNCTION f_trans (p refcur_t) RETURN outrecset PIPELINED;
END refcur_pkg;
/

CREATE OR REPLACE PACKAGE BODY refcur_pkg IS
    FUNCTION f_trans (p refcur_t) RETURN outrecset PIPELINED IS
        out_rec outrec_typ;
        in_rec  p%ROWTYPE;

```

```

BEGIN
  LOOP
    FETCH p INTO in_rec; -- input row
    EXIT WHEN p%NOTFOUND;

    out_rec.var_num := in_rec.employee_id;
    out_rec.var_char1 := in_rec.first_name;
    out_rec.var_char2 := in_rec.last_name;
    PIPE ROW(out_rec); -- first transformed output row

    out_rec.var_char1 := in_rec.email;
    out_rec.var_char2 := in_rec.phone_number;
    PIPE ROW(out_rec); -- second transformed output row
  END LOOP;
  CLOSE p;
  RETURN;
END f_trans;
END refcur_pkg;
/

SELECT * FROM TABLE (
  refcur_pkg.f_trans (
    CURSOR (SELECT * FROM employees WHERE department_id = 60)
  )
);

```

Result:

VAR_NUM	VAR_CHAR1	VAR_CHAR2

103	Alexander	Hunold
103	AHUNOLD	590.423.4567
104	Bruce	Ernst
104	BERNST	590.423.4568
105	David	Austin
105	DAUSTIN	590.423.4569
106	Valli	Pataballa
106	VPATABAL	590.423.4560
107	Diana	Lorentz
107	DLORENTZ	590.423.5567

10 rows selected.

12.5.4 Chaining Pipelined Table Functions

To **chain** pipelined table functions `tf1` and `tf2` is to make the output of `tf1` the input of `tf2`. For example:

```
SELECT * FROM TABLE(tf2(CURSOR(SELECT * FROM TABLE(tf1()))));
```

The rows that `tf1` pipes out must be compatible actual parameters for the formal input parameters of `tf2`.

If chained pipelined table functions are enabled for parallel execution, then each function runs in a different process (or set of processes).

**See Also:**["Passing CURSOR Expressions to Pipelined Table Functions"](#)

12.5.5 Fetching from Results of Pipelined Table Functions

You can associate a named cursor with a query that invokes a pipelined table function. Such a cursor has no special fetch semantics, and such a cursor variable has no special assignment semantics.

However, the SQL optimizer does not optimize across PL/SQL statements. Therefore, in [Example 12-31](#), the first PL/SQL statement is slower than the second—despite the overhead of running two SQL statements in the second PL/SQL statement, and even if function results are piped between the two SQL statements in the first PL/SQL statement.

In [Example 12-31](#), assume that f and g are pipelined table functions, and that each function accepts a cursor variable parameter. The first PL/SQL statement associates cursor variable r with a query that invokes f , and then passes r to g . The second PL/SQL statement passes CURSOR expressions to both f and g .

**See Also:**["Cursor Variables as Subprogram Parameters"](#)

Example 12-31 Fetching from Results of Pipelined Table Functions

```

DECLARE
  r SYS_REFCURSOR;
  ...
  -- First PL/SQL statement (slower):
BEGIN
  OPEN r FOR SELECT * FROM TABLE(f(CURSOR(SELECT * FROM tab)));
  SELECT * BULK COLLECT INTO rec_tab FROM TABLE(g(r));

  -- NOTE: When g completes, it closes r.
END;

-- Second PL/SQL statement (faster):

SELECT * FROM TABLE(g(CURSOR(SELECT * FROM
  TABLE(f(CURSOR(SELECT * FROM tab))))));
/

```

12.5.6 Passing CURSOR Expressions to Pipelined Table Functions

As [Example 12-31](#) shows, the actual parameter for the cursor variable parameter of a pipelined table function can be either a cursor variable or a CURSOR expression, and the latter is more efficient.

 **Note:**

When a SQL `SELECT` statement passes a `CURSOR` expression to a function, the referenced cursor opens when the function begins to run and closes when the function completes.

 **See Also:**

["CURSOR Expressions"](#) for general information about `CURSOR` expressions

[Example 12-32](#) creates a package that includes a pipelined table function with two cursor variable parameters and then invokes the function in a `SELECT` statement, using `CURSOR` expressions for actual parameters.

[Example 12-33](#) uses a pipelined table function as an aggregate function, which takes a set of input rows and returns a single result. The `SELECT` statement selects the function result. (For information about the pseudocolumn `COLUMN_VALUE`, see *Oracle Database SQL Language Reference*.)

Example 12-32 Pipelined Table Function with Two Cursor Variable Parameters

```
CREATE OR REPLACE PACKAGE refcur_pkg AUTHID DEFINER IS
  TYPE refcur_t1 IS REF CURSOR RETURN employees%ROWTYPE;
  TYPE refcur_t2 IS REF CURSOR RETURN departments%ROWTYPE;
  TYPE outrec_typ IS RECORD (
    var_num      NUMBER(6),
    var_char1    VARCHAR2(30),
    var_char2    VARCHAR2(30)
  );
  TYPE outrecset IS TABLE OF outrec_typ;
  FUNCTION g_trans (p1 refcur_t1, p2 refcur_t2) RETURN outrecset PIPELINED;
END refcur_pkg;
/

CREATE PACKAGE BODY refcur_pkg IS
  FUNCTION g_trans (
    p1 refcur_t1,
    p2 refcur_t2
  ) RETURN outrecset PIPELINED
  IS
    out_rec outrec_typ;
    in_rec1 p1%ROWTYPE;
    in_rec2 p2%ROWTYPE;
  BEGIN
    LOOP
      FETCH p2 INTO in_rec2;
      EXIT WHEN p2%NOTFOUND;
    END LOOP;
    CLOSE p2;
    LOOP
      FETCH p1 INTO in_rec1;
      EXIT WHEN p1%NOTFOUND;
      -- first row
```

```

        out_rec.var_num := in_rec1.employee_id;
        out_rec.var_char1 := in_rec1.first_name;
        out_rec.var_char2 := in_rec1.last_name;
        PIPE ROW(out_rec);
        -- second row
        out_rec.var_num := in_rec2.department_id;
        out_rec.var_char1 := in_rec2.department_name;
        out_rec.var_char2 := TO_CHAR(in_rec2.location_id);
        PIPE ROW(out_rec);
    END LOOP;
    CLOSE p1;
    RETURN;
END g_trans;
END refcur_pkg;
/

SELECT * FROM TABLE (
    refcur_pkg.g_trans (
        CURSOR (SELECT * FROM employees WHERE department_id = 60),
        CURSOR (SELECT * FROM departments WHERE department_id = 60)
    )
);

```

Result:

VAR_NUM	VAR_CHAR1	VAR_CHAR2
103	Alexander	Hunold
60	IT	1400
104	Bruce	Ernst
60	IT	1400
105	David	Austin
60	IT	1400
106	Valli	Pataballa
60	IT	1400
107	Diana	Lorentz
60	IT	1400

10 rows selected.

Example 12-33 Pipelined Table Function as Aggregate Function

```

DROP TABLE gradereport;
CREATE TABLE gradereport (
    student VARCHAR2(30),
    subject VARCHAR2(30),
    weight NUMBER,
    grade NUMBER
);

INSERT INTO gradereport (student, subject, weight, grade)
VALUES ('Mark', 'Physics', 4, 4);

INSERT INTO gradereport (student, subject, weight, grade)
VALUES ('Mark', 'Chemistry', 4, 3);

INSERT INTO gradereport (student, subject, weight, grade)
VALUES ('Mark', 'Maths', 3, 3);

INSERT INTO gradereport (student, subject, weight, grade)

```

```

VALUES ('Mark','Economics', 3, 4);

CREATE PACKAGE pkg_gpa AUTHID DEFINER IS
  TYPE gpa IS TABLE OF NUMBER;
  FUNCTION weighted_average(input_values SYS_REFCURSOR)
    RETURN gpa PIPELINED;
END pkg_gpa;

CREATE PACKAGE BODY pkg_gpa IS
  FUNCTION weighted_average (input_values SYS_REFCURSOR)
    RETURN gpa PIPELINED
  IS
    grade          NUMBER;
    total          NUMBER := 0;
    total_weight  NUMBER := 0;
    weight        NUMBER := 0;
  BEGIN
    LOOP
      FETCH input_values INTO weight, grade;
      EXIT WHEN input_values%NOTFOUND;
      total_weight := total_weight + weight; -- Accumulate weighted average
      total := total + grade*weight;
    END LOOP;
    PIPE ROW (total / total_weight);
    RETURN; -- returns single result
  END weighted_average;
END pkg_gpa;

```

This query shows how the table function can be invoked without the optional TABLE operator.

```

SELECT w.column_value "weighted result"
FROM pkg_gpa.weighted_average (
  CURSOR (SELECT weight, grade FROM gradereport)
) w;

```

Result:

```

weighted result
-----
                3.5

```

1 row selected.

12.5.7 DML Statements on Pipelined Table Function Results

The "table" that a pipelined table function returns cannot be the target table of a DELETE, INSERT, UPDATE, or MERGE statement. However, you can create a view of such a table and create INSTEAD OF triggers on the view. For information about INSTEAD OF triggers, see ["INSTEAD OF DML Triggers"](#).

 **See Also:**

Oracle Database SQL Language Reference for information about the `CREATE VIEW` statement

12.5.8 NO_DATA_NEEDED Exception

You must understand the predefined exception `NO_DATA_NEEDED` in two cases:

- You include an `OTHERS` exception handler in a block that includes a `PIPE ROW` statement
- Your code that feeds a `PIPE ROW` statement must be followed by a clean-up procedure

Typically, the clean-up procedure releases resources that the code no longer needs.

When the invoker of a pipelined table function needs no more rows from the function, the `PIPE ROW` statement raises `NO_DATA_NEEDED`. If the pipelined table function does not handle `NO_DATA_NEEDED`, as in [Example 12-34](#), then the function invocation terminates but the invoking statement does not terminate. If the pipelined table function handles `NO_DATA_NEEDED`, its exception handler can release the resources that it no longer needs, as in [Example 12-35](#).

In [Example 12-34](#), the pipelined table function `pipe_rows` does not handle the `NO_DATA_NEEDED` exception. The `SELECT` statement that invokes `pipe_rows` needs only four rows. Therefore, during the fifth invocation of `pipe_rows`, the `PIPE ROW` statement raises the exception `NO_DATA_NEEDED`. The fifth invocation of `pipe_rows` terminates, but the `SELECT` statement does not terminate.

If the exception-handling part of a block that includes a `PIPE ROW` statement includes an `OTHERS` exception handler to handle unexpected exceptions, then it must also include an exception handler for the expected `NO_DATA_NEEDED` exception. Otherwise, the `OTHERS` exception handler handles the `NO_DATA_NEEDED` exception, treating it as an unexpected error. The following exception handler reraises the `NO_DATA_NEEDED` exception, instead of treating it as a irrecoverable error:

```
EXCEPTION
  WHEN NO_DATA_NEEDED THEN
    RAISE;
  WHEN OTHERS THEN
    -- (Put error-logging code here)
    RAISE_APPLICATION_ERROR(-20000, 'Fatal error.');
```

END;

In [Example 12-35](#), assume that the package `External_Source` contains these public items:

- Procedure `Init`, which allocates and initializes the resources that `Next_Row` needs
- Function `Next_Row`, which returns some data from a specific external source and raises the user-defined exception `Done` (which is also a public item in the package) when the external source has no more data
- Procedure `Clean_Up`, which releases the resources that `Init` allocated

The pipelined table function `get_external_source_data` pipes rows from the external source by invoking `External_Source.Next_Row` until either:

- The external source has no more rows.
In this case, the `External_Source.Next_Row` function raises the user-defined exception `External_Source.Done`.
- `get_external_source_data` needs no more rows.
In this case, the `PIPE ROW` statement in `get_external_source_data` raises the `NO_DATA_NEEDED` exception.

In either case, an exception handler in block `b` in `get_external_source_data` invokes `External_Source.Clean_Up`, which releases the resources that `Next_Row` was using.

Example 12-34 Pipelined Table Function Does Not Handle `NO_DATA_NEEDED`

```
CREATE TYPE t IS TABLE OF NUMBER
/
CREATE OR REPLACE FUNCTION pipe_rows RETURN t PIPELINED AUTHID DEFINER IS
  n NUMBER := 0;
BEGIN
  LOOP
    n := n + 1;
    PIPE ROW (n);
  END LOOP;
END pipe_rows;
/
SELECT COLUMN_VALUE
  FROM TABLE(pipe_rows())
 WHERE ROWNUM < 5
/
```

Result:

```
COLUMN_VALUE
-----
          1
          2
          3
          4
```

4 rows selected.

Example 12-35 Pipelined Table Function Handles `NO_DATA_NEEDED`

```
CREATE OR REPLACE FUNCTION get_external_source_data
  RETURN t PIPELINED AUTHID DEFINER IS
BEGIN
  External_Source.Init();           -- Initialize.
  <<b>> BEGIN
    LOOP                             -- Pipe rows from external source.
      PIPE ROW (External_Source.Next_Row());
    END LOOP;
  EXCEPTION
    WHEN External_Source.Done THEN -- When no more rows are available,
      External_Source.Clean_Up();  -- clean up.
    WHEN NO_DATA_NEEDED THEN      -- When no more rows are needed,
      External_Source.Clean_Up();  -- clean up.
      RAISE NO_DATA_NEEDED;        -- Optional, equivalent to RETURN.
  END b;
END get_external_source_data;
/
```

12.6 Overview of Polymorphic Table Functions

Polymorphic table functions (PTF) are table functions whose operands can have more than one type. The return type is determined by the PTF invocation arguments list. The actual arguments to the table type usually determines the row output shape, but not always.

Introduction to Polymorphic Table Functions

Polymorphic Table Functions (PTF) are user-defined functions that can be invoked in the `FROM` clause of a SQL query block. They are capable of processing tables whose row type is not declared at definition time and producing a result table whose row type may or may not be declared at definition time. Polymorphic table functions leverage dynamic SQL capabilities to create powerful and complex custom functions. This is useful for applications demanding an interface with generic extensions which work for arbitrary input tables or queries.

A PTF author creates an interface to a procedural mechanism that defines a table. The PTF author defines, documents, and implements the PTF.

The query author can only describe the published interface and invoke the PTF function in queries.

The database is the PTF conductor. It manages the compilation and execution states of the PTF. The database and the PTF author can see a family of related SQL invoked procedures, called the PTF component procedures, and possibly additional private data (such as variables and cursors).

Types of Polymorphic Table Functions

The polymorphic table function type is specified based on their formal arguments list semantics:

- If an input `TABLE` argument has `Row Semantics`, the input is a single row.
- If an input `TABLE` argument has `Table Semantics`, the input is a set of rows. When a `Table Semantics` PTF is called from a query, the table argument can optionally be extended with either a `PARTITION BY` clause or an `ORDER BY` clause or both.

12.6.1 Polymorphic Table Function Definition

The PTF author defines, documents, and implements the Polymorphic Table Function (PTF).

A PTF has two parts:

1. The PL/SQL package which contains the client interface for the PTF implementation.
2. The standalone or package function naming the PTF and its associated implementation package.

12.6.2 Polymorphic Table Function Implementation

The Polymorphic Table Function (PTF) implementation client interface is a set of subprograms with fixed names that every PTF must provide.

Steps to Implement a Polymorphic Table Function

1. Create the implementation package containing the `DESCRIBE` function (required) and the `OPEN`, `FETCH_ROWS`, and `CLOSE` procedures (optional).
2. Create the function specification naming the PTF. The function can be created at the top-level after the package has been created, or as a package function in the implementation package (the package created in the first step). Polymorphic table functions do not have a function definition (a `FUNCTION BODY`), the definition is encapsulated in the associated implementation package.

The function definition specifies :

- The Polymorphic Table Function (PTF) name
- Exactly one formal argument of type `TABLE` and any number of non `TABLE` arguments
- The return type of the PTF as `TABLE`
- The type of PTF function (`row` or `table semantics`)
- The PTF implementation package name



See Also:

- *Oracle Database PL/SQL Packages and Types Reference* for information about a `DESCRIBE` Only polymorphic table function
- *Oracle Database PL/SQL Packages and Types Reference* for more information about how to specify the PTF implementation package and use the `DBMS_TF` utilities
- [PIPELINED Clause](#) for the standalone or package polymorphic table function creation syntax and semantic

12.6.3 Polymorphic Table Function Invocation

A polymorphic table function is invoked by specifying its name followed by the argument list in the `FROM` clause of a SQL query block.

The PTF arguments can be the standard scalar arguments that can be passed to a regular table function, but PTF's can additionally take a table argument. A table argument is either a `WITH` clause query or a schema-level object that is allowed in a `FROM` clause (such as tables, views, or table functions).

Syntax

```
table_argument ::= table [ PARTITION BY column_list ] [ORDER BY  
order_column_list]
```

column_list ::= *identifier* | (*identifier* [, *identifier*...])

order_column_list ::= *order_column_name* | (*order_column_name* [, *order_column_name*...])

order_column_name ::= *identifier* [ASC | DESC][NULLS FIRST | NULLS LAST]

Semantics

Each identifier is a column in the corresponding table.

The PTF has `Table Semantics`.

Query can optionally partition and order `Table Semantics` PTF input. This is disallowed for `Row Semantics` PTF input.

A polymorphic table function (PTF) cannot be the target of a DML statement. Any table argument of a PTF is passed in by name.

For example, the `noop` PTF can be used in a query such as :

```
SELECT *
FROM noop(emp);
```

or

```
WITH e AS
  (SELECT * FROM emp NATURAL JOIN dept)
SELECT t.* FROM noop(e) t;
```

The input table argument must be a basic table name.

The name resolution rules of the table identifier are (in priority order) as follows :

1. Identifier is resolved as a column name (such as a correlated column from an outer query block).
2. Identifier is resolved as a Common Table Expression (CTE) name in the current or some outer query-block. CTE is commonly known as the `WITH` clause.
3. Identifier is resolved as a schema-level table, view, or table-function (regular or polymorphic, and defined either at the schema-level or inside a package).

Many types of table expressions otherwise allowed in the `FROM` clause cannot be directly used as a table argument for a PTF (such as ANSI Joins, bind-variables, in-line views, `CURSOR` operators, `TABLE` operators). To use such table expressions as a PTF argument, these table expressions must be passed indirectly into a PTF by wrapping them in a CTE and then passing the CTE name into the PTF.

A PTF can be used as a table reference in the `FROM` clause and thus can be part of the ANSI Join and `LATERAL` syntax. Additionally, a PTF can be the source table for `PIVOT/UNPIVOT` and `MATCH_RECOGNIZE`. Some table modification clauses that are meant for tables and views (such as `SAMPLING`, `PARTITION`, `CONTAINERS`) are disallowed for PTF.

Direct function composition of PTF is allowed (such as nested PTF cursor expression invocation or `PTF(TF())` nesting). However, nested PTF is disallowed (such as `PTF(PTF())` nesting).

The scalar arguments of a PTF can be any SQL scalar expression. While the constant scalar values are passed as-is to the `DESCRIBE` function, all other values are passed as `NULLS`. This is usually not a problem for the PTF implementation if these values are not row shape determining, but otherwise the `DESCRIBE` function can raise an error; typically the

documentation accompanying the PTF will state which scalar parameters, if any, are shape defining and thus must have constant non-null values. Note, that during query execution (during `OPEN`, `FETCH_ROWS`, `CLOSE`) the expressions are evaluated and their actual values are passed to these PTF execution procedures. The return type is determined by the PTF invocation arguments list.

Query arguments are passed to PTF using a `WITH` clause.

The `TABLE` operator is optional when the table function arguments list or empty list `()` appears.

12.6.3.1 Variadic Pseudo-Operators

A variadic pseudo-operator operates with a variable number of operands.

Starting with Oracle Database Release 18c, we introduce the concept of variadic pseudo-operator into the SQL expression language to support Polymorphic Table Functions (PTF). A pseudo-operator can be used to pass list of identifiers (such as column name) to a PTF. A pseudo-operator can only appear as arguments to PTFs, and are parsed by the SQL compiler like other SQL operators or PL/SQL function invocation. A pseudo-operator has a variable number of arguments but must have at least one. The pseudo-operator does not have any execution function associated with it, and they are completely removed from the SQL cursor after the PTF compilation is finished. During SQL compilation, the pseudo-operators are converted to corresponding `DBMS_TF` types and then passed to the `DESCRIBE` method. There is no output type associated with these operators. It is not possible to embed a pseudo-operator inside a general SQL expression.

12.6.3.2 COLUMNS Pseudo-Operator

You can use the `COLUMNS` pseudo-operator to specify arguments to a Polymorphic Table Function (PTF) invocation in the `FROM` clause of a SQL query block.

The `COLUMNS` pseudo-operator arguments specify the list of column names, or the list of column names with associated types.

Syntax

```
column_operator ::= COLUMNS ( column_list )
```

```
column_list ::= column_name_list | column_type_list
```

```
column_name_list ::= identifier [, identifier ... ]
```

```
column_type_list::= identifier column_type [, identifier column_type...]
```

Semantics

The `COLUMNS` pseudo-operator can only appear as an argument to a PTF. It cannot appear in any other SQL expression than the PTF expression itself.

The *column_type* must be a scalar type.

12.6.4 Polymorphic Table Function Compilation and Execution

The database fulfills the Polymorphic Table Functions (PTF) conductor role. As such, it is responsible for the PTF compilation, execution and its related states.

The database manages :

- The compilation state : This is the immutable state that is generated by `DESCRIBE` which is needed before execution.
- The execution state: This is the state used by the execution procedures of a `Table semantics` PTF.

See Also:

- *Oracle Database PL/SQL Packages and Types Reference* for more information about how the database manages the compilation and execution states of the PTFs

12.6.5 Polymorphic Table Function Optimization

A polymorphic table function (PTF) provides an efficient and scalable mechanism to extend the analytical capabilities of the database.

The key benefits are:

- Minimal data-movement: Only columns of interest are passed to PTF
- Predicates/Projections/Partitioning are/is pushed into underlying table/query (where semantically possible)
- Bulk data transfer into and out of PTF
- Parallelism is based on type of PTF and query specified partitioning (if any)

12.6.6 Skip_col Polymorphic Table Function Example

This PTF example demonstrates Row Semantics, Describe Only, package table function, and overloading features.

See Also:

- *Oracle Database PL/SQL Packages and Types Reference* for more Polymorphic Table Function (PTF) examples

Example 12-36 Skip_col Polymorphic Table Function Example

The skip_col Polymorphic Table Function (PTF) returns all the columns in a table except the columns specified in the PTF input argument. The skip_col PTF skips columns based on column names (overload 1) or columns data type (overload 2).

 **Live SQL:**

You can view and run this example on Oracle Live SQL at [18c Skip_col Polymorphic Table Function](#)

Create the implementation package named skip_col_pkg containing the DESCRIBE function for the skip_col polymorphic table function (PTF). The DESCRIBE function is invoked to determine the row shape produced by the PTF. It returns a DBMS_TF.DESCRIBE_T table. It is overloaded. The FETCH_ROWS procedure is not required because it does not need to produce associated new column values for a given subset of rows.

```
CREATE PACKAGE skip_col_pkg AS

  -- OVERLOAD 1: Skip by name --
  FUNCTION skip_col(tab TABLE,
                   col COLUMNS)
    RETURN TABLE PIPELINED ROW POLYMORPHIC USING skip_col_pkg;

  FUNCTION describe(tab IN OUT DBMS_TF.TABLE_T,
                   col      DBMS_TF.COLUMNS_T)
    RETURN DBMS_TF.DESCRIBE_T;

  -- OVERLOAD 2: Skip by type --
  FUNCTION skip_col(tab      TABLE,
                   type_name VARCHAR2,
                   flip      VARCHAR2 DEFAULT 'False')
    RETURN TABLE PIPELINED ROW POLYMORPHIC USING skip_col_pkg;

  FUNCTION describe(tab      IN OUT DBMS_TF.TABLE_T,
                   type_name  VARCHAR2,
                   flip        VARCHAR2 DEFAULT 'False')
    RETURN DBMS_TF.DESCRIBE_T;

END skip_col_pkg;
```

Create the implementation package body which contains the polymorphic table function definition.

```
CREATE PACKAGE BODY skip_col_pkg AS

/* OVERLOAD 1: Skip by name
 * Package PTF name: skip_col_pkg.skip_col
 * Standalone PTF name: skip_col_by_name
 *
 * PARAMETERS:
```

```

* tab - The input table
* col - The name of the columns to drop from the output
*
* DESCRIPTION:
*   This PTF removes all the input columns listed in col from the output
*   of the PTF.
*/
FUNCTION describe(tab IN OUT DBMS_TF.TABLE_T,
                 col   DBMS_TF.COLUMNS_T)
  RETURN DBMS_TF.DESCRIBE_T
AS
  new_cols DBMS_TF.COLUMNS_NEW_T;
  col_id   PLS_INTEGER := 1;
BEGIN
  FOR i IN 1 .. tab.column.count() LOOP
    FOR j IN 1 .. col.count() LOOP
      tab.column(i).PASS_THROUGH := tab.column(i).DESCRIPTION.NAME !=
col(j);
      EXIT WHEN NOT tab.column(i).PASS_THROUGH;
    END LOOP;
  END LOOP;

  RETURN NULL;
END;

/* OVERLOAD 2: Skip by type
* Package PTF name: skip_col_pkg.skip_col
* Standalone PTF name: skip_col_by_type
*
* PARAMETERS:
*   tab          - Input table
*   type_name    - A string representing the type of columns to skip
*   flip         - 'False' [default] => Match columns with given type_name
*                 otherwise          => Ignore columns with given type_name
*
* DESCRIPTION:
*   This PTF removes the given type of columns from the given table.
*/
FUNCTION describe(tab          IN OUT DBMS_TF.TABLE_T,
                 type_name    VARCHAR2,
                 flip         VARCHAR2 DEFAULT 'False')
  RETURN DBMS_TF.DESCRIBE_T
AS
  typ CONSTANT VARCHAR2(1024) := UPPER(TRIM(type_name));
BEGIN
  FOR i IN 1 .. tab.column.count() LOOP
    tab.column(i).PASS_THROUGH :=
      CASE UPPER(SUBSTR(flip,1,1))
        WHEN 'F' THEN DBMS_TF.column_type_name(tab.column(i).DESCRIPTION) !
=typ
      ELSE
        DBMS_TF.column_type_name(tab.column(i).DESCRIPTION)
=typ
      END /* case */;
  END LOOP;

```



```

        RETURN NULL;
    END;

END skip_col_pkg;

```

Create a standalone polymorphic table function named `skip_col_by_name` for overload 1. Specify exactly one formal argument of type `TABLE`, specify the return type of the PTF as `TABLE`, specify a Row Semantics PTF type, and indicate the PTF implementation package to use is `skip_col_pkg`.

```

CREATE FUNCTION skip_col_by_name(tab TABLE,
                                col COLUMNS)
    RETURN TABLE PIPELINED ROW POLYMORPHIC USING
skip_col_pkg;

```

Create a standalone polymorphic table function named `skip_col_by_type` for overload 2. Specify exactly one formal argument of type `TABLE`, specify the return type of the PTF as `TABLE`, specify a Row Semantics PTF type, and indicate the PTF implementation package to use is `skip_col_pkg`.

```

CREATE FUNCTION skip_col_by_type(tab TABLE,
                                type_name VARCHAR2,
                                flip VARCHAR2 DEFAULT 'False')
    RETURN TABLE PIPELINED ROW POLYMORPHIC USING
skip_col_pkg;

```

Invoke the package `skip_col` PTF (overload 1) to report from the `SCOTT.DEPT` table only columns whose type is not `NUMBER`.

```
SELECT * FROM skip_col_pkg.skip_col(scott.dept, 'number');
```

DNAME	LOC
ACCOUNTING	NEW YORK
RESEARCH	DALLAS
SALES	CHICAGO
OPERATIONS	BOSTON

The same result can be achieved by invoking the standalone `skip_col_by_type` PTF to report from the `SCOTT.DEPT` table only columns whose type is not `NUMBER`.

```
SELECT * FROM skip_col_by_type(scott.dept, 'number');
```

DNAME	LOC
ACCOUNTING	NEW YORK
RESEARCH	DALLAS
SALES	CHICAGO
OPERATIONS	BOSTON

Invoke the package `skip_col` PTF (overload 2) to report from the `SCOTT.DEPT` table only columns whose type is `NUMBER`.

```
SELECT * FROM skip_col_pkg.skip_col(scott.dept, 'number', flip => 'True');
```

```

DEPTNO
-----
      10
      20
      30
      40

```

The same result can be achieved by invoking the standalone `skip_col_by_type` PTF to report from the `SCOTT.DEPT` table only columns whose type is `NUMBER`.

```
SELECT * FROM skip_col_by_type(scott.dept, 'number', flip => 'True');
```

```

DEPTNO
-----
      10
      20
      30
      40

```

Invoke the package `skip_col` PTF to report all employees in department 20 from the `SCOTT.EMP` table all columns except `COMM`, `HIREDATE` and `MGR`.

```

SELECT *
FROM skip_col_pkg.skip_col(scott.emp, COLUMNS(comm, hiredate, mgr))
WHERE deptno = 20;
```

```

EMPNO ENAME      JOB              SAL      DEPTNO
-----
 7369 SMITH       CLERK            800       20
 7566 JONES       MANAGER         2975      20
 7788 SCOTT       ANALYST         3000      20
 7876 ADAMS      CLERK           1100      20
 7902 FORD        ANALYST         3000      20

```

12.6.7 To_doc Polymorphic Table Function Example

The `to_doc` PTF example combines a list of specified columns into a single document column.

Example 12-37 To_doc Polymorphic Table Function Example

The `to_doc` PTF combines a list of columns into a document column constructed like a JSON object.



Live SQL:

You can view and run this example on Oracle Live SQL at [18c To_doc Polymorphic Table Function](#)

Create the implementation package `to_doc_p` containing the `DESCRIBE` function and `FETCH_ROWS` procedure for the `to_doc` polymorphic table function (PTF).

The PTF parameters are :

- `tab` : The input table (The `tab` parameter is of type `DBMS_TF.TABLE_T`, a table descriptor record type)
- `cols` (optional) : The list of columns to convert to document. (The `cols` parameter is type `DBMS_TF.COLUMNS_T`, a column descriptor record type)

```
CREATE PACKAGE to_doc_p AS
    FUNCTION describe(tab      IN OUT DBMS_TF.TABLE_T,
                     cols     IN      DBMS_TF.COLUMNS_T DEFAULT NULL)
        RETURN DBMS_TF.DESCRIBE_T;

    PROCEDURE fetch_rows;
END to_doc_p;
```

Create the package containing the `DESCRIBE` function and `FETCH_ROWS` procedure. The `FETCH_ROWS` procedure is required to produce a new column named `DOCUMENT` in the output rowset. The `DESCRIBE` function indicates the read columns by annotating them in the input table descriptor, `TABLE_T`. Only the indicated read columns will be fetched and thus available for processing during `FETCH_ROWS`. The PTF invocation in a query can use the `COLUMNS` pseudo-operator to indicate which columns the query wants the PTF to read, and this information is passed to the `DESCRIBE` function which then in turn sets the `COLUMN_T.FOR_READ` boolean flag. Only scalar SQL data types are allowed for the read columns. The `COLUMN_T.PASS_THROUGH` boolean flag indicates columns that are passed from the input table of the PTF to the output, without any modifications.

```
CREATE PACKAGE BODY to_doc_p AS

    FUNCTION describe(tab      IN OUT DBMS_TF.TABLE_T,
                     cols     IN      DBMS_TF.COLUMNS_T DEFAULT NULL)
        RETURN DBMS_TF.DESCRIBE_T AS

    BEGIN
        FOR i IN 1 .. tab.column.count LOOP
            CONTINUE WHEN NOT
                DBMS_TF.SUPPORTED_TYPE(tab.column(i).DESCRIPTION.TYPE);

            IF cols IS NULL THEN
                tab.column(i).FOR_READ      := TRUE;
                tab.column(i).PASS_THROUGH := FALSE;
                CONTINUE;
            END IF;

            FOR j IN 1 .. cols.count LOOP
                IF (tab.column(i).DESCRIPTION.NAME = cols(j)) THEN
                    tab.column(i).FOR_READ      := TRUE;
                    tab.column(i).PASS_THROUGH := FALSE;
                END IF;
            END LOOP;

        END LOOP;

    END LOOP;
```

```

        RETURN DBMS_TF.describe_t(new_columns => DBMS_TF.COLUMNS_NEW_T(1 =>
                                                DBMS_TF.COLUMN_METADATA_T(name
=>'DOCUMENT')));
END;

PROCEDURE fetch_rows AS
    rst DBMS_TF.ROW_SET_T;
    col DBMS_TF.TAB_VARCHAR2_T;
    rct PLS_INTEGER;
BEGIN
    DBMS_TF.GET_ROW_SET(rst, row_count => rct);
    FOR rid IN 1 .. rct LOOP
        col(rid) := DBMS_TF.ROW_TO_CHAR(rst, rid);
    END LOOP;
    DBMS_TF.PUT_COL(1, col);
END;

END to_doc_p;

```

Create the standalone `to_doc` PTF. Specify exactly one formal argument of type `TABLE`, specify the return type of the PTF as `TABLE`, specify a Row Semantics PTF type, and indicate the PTF implementation package to use is `to_doc_p`.

```

CREATE FUNCTION to_doc(
    tab TABLE,
    cols COLUMNS DEFAULT NULL)
RETURN TABLE
PIPELINED ROW POLYMORPHIC USING to_doc_p;

```

Invoke the `to_doc` PTF to display all columns of table `SCOTT.DEPT` as one combined `DOCUMENT` column.

```

SELECT * FROM to_doc(scott.dept);

DOCUMENT
-----
{"DEPTNO":10, "DNAME":"ACCOUNTING", "LOC":"NEW YORK"}
{"DEPTNO":20, "DNAME":"RESEARCH", "LOC":"DALLAS"}
{"DEPTNO":30, "DNAME":"SALES", "LOC":"CHICAGO"}
{"DEPTNO":40, "DNAME":"OPERATIONS", "LOC":"BOSTON"}

```

For all employees in departments 10 and 30, display the `DEPTNO`, `ENAME` and `DOCUMENT` columns ordered by `DEPTNO` and `ENAME`. Invoke the `to_doc` PTF with the `COLUMNS` pseudo-operator to select columns `EMPNO`, `JOB`, `MGR`, `HIREDATE`, `SAL` and `COMM` of table `SCOTT.EMP`. The PTF combines these columns into the `DOCUMENT` column.

```

SELECT deptno, ename, document
FROM   to_doc(scott.emp, COLUMNS(empno,job,mgr,hiredate,sal,comm))
WHERE  deptno IN (10, 30)
ORDER BY 1, 2;

```

```

DEPTNO ENAME      DOCUMENT
-----
10 CLARK      {"EMPNO":7782, "JOB":"MANAGER", "MGR":7839, "HIREDATE":"09-
JUN-81", "SAL":2450}
10 KING      {"EMPNO":7839, "JOB":"PRESIDENT", "HIREDATE":"17-NOV-81",
"SAL":5000}
10 MILLER     {"EMPNO":7934, "JOB":"CLERK", "MGR":7782, "HIREDATE":"23-
JAN-82", "SAL":1300}
30 ALLEN      {"EMPNO":7499, "JOB":"SALESMAN", "MGR":7698, "HIREDATE":"20-
FEB-81", "SAL":1600, "COMM":300}
30 BLAKE      {"EMPNO":7698, "JOB":"MANAGER", "MGR":7839, "HIREDATE":"01-
MAY-81", "SAL":2850}
30 JAMES      {"EMPNO":7900, "JOB":"CLERK", "MGR":7698, "HIREDATE":"03-
DEC-81", "SAL":950}
30 MARTIN     {"EMPNO":7654, "JOB":"SALESMAN", "MGR":7698, "HIREDATE":"28-
SEP-81", "SAL":1250, "COMM":1400}
30 TURNER     {"EMPNO":7844, "JOB":"SALESMAN", "MGR":7698, "HIREDATE":"08-
SEP-81", "SAL":1500, "COMM":0}
30 WARD       {"EMPNO":7521, "JOB":"SALESMAN", "MGR":7698, "HIREDATE":"22-
FEB-81", "SAL":1250, "COMM":500}

```

With the subquery named `e`, display the `DOC_ID` and `DOCUMENT` columns. Report all clerk employees, their salary, department and department location. Use the `to_doc` PTF to combine the `NAME`, `SAL`, `DEPTNO` and `LOC` columns into the `DOCUMENT` column.

```

WITH e AS (
  SELECT ename name, sal, deptno, loc
  FROM scott.emp NATURAL JOIN scott.dept
  WHERE job = 'CLERK')
SELECT ROWNUM doc_id, t.*
FROM to_doc(e) t;

```

```

DOC_ID DOCUMENT
-----
1 {"NAME":"MILLER", "SAL":1300, "DEPTNO":10, "LOC":"NEW YORK"}
2 {"NAME":"SMITH", "SAL":800, "DEPTNO":20, "LOC":"DALLAS"}
3 {"NAME":"ADAMS", "SAL":1100, "DEPTNO":20, "LOC":"DALLAS"}
4 {"NAME":"JAMES", "SAL":950, "DEPTNO":30, "LOC":"CHICAGO"}

```

Use a subquery block to display `c1`, `c2`, `c3` column values converted into the `DOCUMENT` column.

```

WITH t(c1,c2,c3) AS (
  SELECT NULL, NULL, NULL FROM dual
  UNION ALL
  SELECT 1, NULL, NULL FROM dual
  UNION ALL
  SELECT NULL, 2, NULL FROM dual
  UNION ALL
  SELECT 0, NULL, 3 FROM dual)
SELECT *
FROM to_doc(t);

```

```

DOCUMENT
-----
{}

```

```

{"C1":1}
{"C2":2}
{"C1":0, "C3":3}

```

For all employees in department 30, display the values of the member with property names ENAME and COMM. The PTF invocation reporting from the SCOTT.EMP table produces the DOCUMENT column which can be used as input to the JSON_VALUE function. This function selects a scalar value from some JSON data.

```

SELECT JSON_VALUE(document, '$.ENAME') ename,
       JSON_VALUE(document, '$.COMM')  comm
FROM   to_doc(scott.emp)
WHERE  JSON_VALUE(document, '$.DEPTNO') = 30;

```

ENAME	COMM
-----	----
ALLEN	300
WARD	500
MARTIN	1400
BLAKE	
TURNER	0
JAMES	

12.6.8 Implicit_echo Polymorphic Table Function Example

The implicit_echo PTF example demonstrates that the USING clause is optional when the Polymorphic Table Function and the DESCRIBE function are defined in the same package.

Example 12-38 Implicit_echo Polymorphic Table Function Example

The implicit_echo PTF, takes in a table and a column and produces a new column with the same value.

This PTF returns the column in the input table tab, and adds to it the column listed in cols but with the column names prefixed with "ECHO_".

Create the implementation package implicit_echo_package containing the DESCRIBE function, implicit_echo polymorphic table function (PTF) and FETCH_ROWS procedure.

```

CREATE PACKAGE implicit_echo_package AS
  prefix  DBMS_ID := '"ECHO_';

  FUNCTION DESCRIBE(tab    IN OUT DBMS_TF.TABLE_T,
                   cols   IN     DBMS_TF.COLUMNS_T)
    RETURN DBMS_TF.DESCRIBE_T;

  PROCEDURE FETCH_ROWS;

  -- PTF FUNCTION: WITHOUT USING CLAUSE --
  FUNCTION implicit_echo(tab TABLE, cols COLUMNS)
    RETURN TABLE PIPELINED ROW POLYMORPHIC;

END implicit_echo_package;

```

Create the package containing the `DESCRIBE` function containing the input table parameter and the column parameter to be read. This function is invoked to determine the type of rows produced by the Polymorphic Table Function. The function returns a table `DBMS_TF.DESCRIBE_T`. The `FETCH_ROWS` procedure is required to produce the indicated read column along with a new column prefixed with "ECHO_" in the output rowset. The `implicit_echo` is the PTF function and contains two arguments, `tab` and `cols`, whose values are obtained from the query and this information is passed to the `DESCRIBE` function. The Row semantics specifies a PTF type but without the `USING` clause. This function is invoked from the SQL query.

Create the implementation package body `implicit_echo_package` which contains the PTF definition.

```
CREATE PACKAGE BODY implicit_echo_package AS

FUNCTION DESCRIBE(tab IN OUT DBMS_TF.TABLE_T,
                 cols IN      DBMS_TF.COLUMNS_T)
RETURN DBMS_TF.DESCRIBE_T
AS
    new_cols DBMS_TF.COLUMNS_NEW_T;
    col_id   PLS_INTEGER := 1;

BEGIN
    FOR i in 1 .. tab.column.COUNT LOOP

        FOR j in 1 .. cols.COUNT LOOP

            IF (tab.column(i).description.name = cols(j)) THEN

                IF (NOT DBMS_TF.SUPPORTED_TYPE(tab.column(i).description.type))
THEN
                    RAISE_APPLICATION_ERROR(-20102, 'Unsupported column
type['||
tab.column(i).description.type||']');
                    END IF;

                    tab.column(i).for_read := TRUE;
                    new_cols(col_id)      := tab.column(i).description;
                    new_cols(col_id).name := prefix||

REGEXP_REPLACE(tab.column(i).description.name,
'^"|"$');
                    col_id                := col_id + 1;
                    EXIT;

                END IF;

            END LOOP;

        END LOOP;

    END LOOP;

/* VERIFY ALL COLUMNS WERE FOUND */
IF (col_id - 1 != cols.COUNT) then
```

```

        RAISE_APPLICATION_ERROR(-20101, 'Column mismatch['||col_id-1||'],
                                          ['||cols.COUNT||']');
    END IF;

    RETURN DBMS_TF.DESCRIBE_T(new_columns => new_cols);

END;

PROCEDURE FETCH_ROWS AS
    rowset DBMS_TF.ROW_SET_T;
BEGIN
    DBMS_TF.GET_ROW_SET(rowset);
    DBMS_TF.PUT_ROW_SET(rowset);
END;

END implicit_echo_package;

```

Invoke the PTF to display ENAME column of table SCOTT.EMP and display it along with another column ECHO_ENAME having the same value.

```

SELECT ENAME, ECHO_ENAME
FROM implicit_echo_package.implicit_echo(SCOTT.EMP, COLUMNS(SCOTT.ENAME));

```

ENAME	ECHO_ENAME
SMITH	SMITH
ALLEN	ALLEN
WARD	WARD
JONES	JONES
MARTIN	MARTIN
BLAKE	BLAKE
CLARK	CLARK
SCOTT	SCOTT
KING	KING
TURNER	TURNER
ADAMS	ADAMS
JAMES	JAMES
FORD	FORD
MILLER	MILLER

12.7 Updating Large Tables in Parallel

The `DBMS_PARALLEL_EXECUTE` package lets you incrementally update the data in a large table in parallel, in two high-level steps:

1. Group sets of rows in the table into smaller chunks.
2. Apply the desired `UPDATE` statement to the chunks in parallel, committing each time you have finished processing a chunk.

This technique is recommended whenever you are updating a lot of data. Its advantages are:

- You lock only one set of rows at a time, for a relatively short time, instead of locking the entire table.
- You do not lose work that has been done if something fails before the entire operation finishes.

- You reduce rollback space consumption.
- You improve performance.



See Also:

Oracle Database PL/SQL Packages and Types Reference for more information about the `DBMS_PARALLEL_EXECUTE` package

12.8 Collecting Data About User-Defined Identifiers

PL/Scope extracts, organizes, and stores data about PL/SQL and SQL identifiers and SQL statements from PL/SQL source text. You can retrieve the identifiers and statements data with the static data dictionary views `*_IDENTIFIERS` and `*_STATEMENTS`.



See Also:

- [PL/SQL Units and Compilation Parameters](#) for more information about `PLSQL_SETTINGS` parameter
- *Oracle Database Development Guide* for more information about using PL/Scope

12.9 Profiling and Tracing PL/SQL Programs

To help you isolate performance problems in large PL/SQL programs, PL/SQL provides these tools, implemented as PL/SQL packages.

Table 12-1 Profiling and Tracing Tools Summary

Tool	Package	Description
Profiler interface	<code>DBMS_PROFILER</code>	<p>Computes the time that your PL/SQL program spends at each line and in each subprogram. You must have <code>CREATE</code> privileges on the units to be profiled.</p> <p>Saves runtime statistics in database tables, which you can query.</p>
Trace interface	<code>DBMS_TRACE</code>	<p>Traces the order in which subprograms run. You can specify the subprograms to trace and the tracing level.</p> <p>Saves runtime statistics in database tables, which you can query.</p>

Table 12-1 (Cont.) Profiling and Tracing Tools Summary

Tool	Package	Description
PL/SQL hierarchical profiler	DBMS_HPROF	<p>Reports the dynamic execution program profile of your PL/SQL program, organized by subprogram invocations. Accounts for SQL and PL/SQL execution times separately.</p> <p>Requires no special source or compile-time preparation.</p> <p>Generates reports in HTML. Provides the option of storing profiler data and results in relational format in database tables for custom report generation (such as third-party tools offer).</p>
SQL trace	DBMS_APPLICATION_INFO	<p>Uses the DBMS_APPLICATION_INFO package with Oracle Trace and the SQL trace facility to record names of executing modules or transactions in the database for later use when tracking the performance of various modules and debugging.</p>
PL/SQL Basic Block Coverage	DBMS_PLSQL_CODE_COVERAGE	<p>Collects and analyzes basic block coverage data.</p>
Call Stack Utilities	UTL_CALL_STACK	<p>Provides information about currently executing subprograms (such as subprogram names, unit names, owner names, edition names, and error stack information) that you can use to create more revealing error logs and application execution traces.</p>

Related Topics

- *Oracle Database PL/SQL Packages and Types Reference* for more information about the DBMS_APPLICATION_INFO package
- *Oracle Database PL/SQL Packages and Types Reference* for more information about the DBMS_HPROF package
- *Oracle Database PL/SQL Packages and Types Reference* for more information about the DBMS_PLSQL_CODE_COVERAGE package
- *Oracle Database PL/SQL Packages and Types Reference* for more information about the DBMS_PROFILER package
- *Oracle Database PL/SQL Packages and Types Reference* for more information about the DBMS_TRACE package
- *Oracle Database PL/SQL Packages and Types Reference* for more information about the UTL_CALL_STACK package
- [COVERAGE Pragma](#) for the syntax and semantics of COVERAGE PRAGMA
- *Oracle Database Development Guide* for more information about using PL/SQL basic block coverage
- *Oracle Database Development Guide* for a detailed description of PL/SQL hierarchical profiler

- *Oracle Database Development Guide* for more information about analyzing and debugging stored subprograms

12.10 Compiling PL/SQL Units for Native Execution

You can usually speed up PL/SQL units by compiling them into native code (processor-dependent system code), which is stored in the SYSTEM tablespace.

You can natively compile any PL/SQL unit of any type, including those that Oracle Database supplies.

Natively compiled program units work in all server environments, including shared server configuration (formerly called "multithreaded server") and Oracle Real Application Clusters (Oracle RAC).

On most platforms, PL/SQL native compilation requires no special set-up or maintenance. On some platforms, the DBA might want to do some optional configuration.

See Also:

- *Oracle Database Administrator's Guide* for information about configuring a database
- Platform-specific configuration documentation for your platform

You can test to see how much performance gain you can get by enabling PL/SQL native compilation.

If you have determined that PL/SQL native compilation will provide significant performance gains in database operations, Oracle recommends compiling the entire database for native mode, which requires DBA privileges. This speeds up both your own code and calls to the PL/SQL packages that Oracle Database supplies.

Topics

- [Determining Whether to Use PL/SQL Native Compilation](#)
- [How PL/SQL Native Compilation Works](#)
- [Dependencies, Invalidation, and Revalidation](#)
- [Setting Up a New Database for PL/SQL Native Compilation*](#)
- [Compiling the Entire Database for PL/SQL Native or Interpreted Compilation*](#)

* Requires DBA privileges.

12.10.1 Determining Whether to Use PL/SQL Native Compilation

Whether to compile a PL/SQL unit for native or interpreted mode depends on where you are in the development cycle and on what the program unit does.

While you are debugging program units and recompiling them frequently, interpreted mode has these advantages:

- You can use PL/SQL debugging tools on program units compiled for interpreted mode (but not for those compiled for native mode).
- Compiling for interpreted mode is faster than compiling for native mode.

After the debugging phase of development, in determining whether to compile a PL/SQL unit for native mode, consider:

- PL/SQL native compilation provides the greatest performance gains for computation-intensive procedural operations. Examples are data warehouse applications and applications with extensive server-side transformations of data for display.
- PL/SQL native compilation provides the least performance gains for PL/SQL subprograms that spend most of their time running SQL.
- When many program units (typically over 15,000) are compiled for native execution, and are simultaneously active, the large amount of shared memory required might affect system performance.

12.10.2 How PL/SQL Native Compilation Works

Without native compilation, the PL/SQL statements in a PL/SQL unit are compiled into an intermediate form, system code, which is stored in the catalog and interpreted at run time.

With PL/SQL native compilation, the PL/SQL statements in a PL/SQL unit are compiled into native code and stored in the catalog. The native code need not be interpreted at run time, so it runs faster.

Because native compilation applies only to PL/SQL statements, a PL/SQL unit that uses only SQL statements might not run faster when natively compiled, but it does run at least as fast as the corresponding interpreted code. The compiled code and the interpreted code make the same library calls, so their action is the same.

The first time a natively compiled PL/SQL unit runs, it is fetched from the SYSTEM tablespace into shared memory. Regardless of how many sessions invoke the program unit, shared memory has only one copy it. If a program unit is not being used, the shared memory it is using might be freed, to reduce memory load.

Natively compiled subprograms and interpreted subprograms can invoke each other.

PL/SQL native compilation works transparently in an Oracle Real Application Clusters (Oracle RAC) environment.

The `PLSQL_CODE_TYPE` compilation parameter determines whether PL/SQL code is natively compiled or interpreted. For information about this compilation parameters, see "[PL/SQL Units and Compilation Parameters](#)".

12.10.3 Dependencies, Invalidation, and Revalidation

Recompilation is automatic with invalidated PL/SQL modules. For example, if an object on which a natively compiled PL/SQL subprogram depends changes, the subprogram is invalidated. The next time the same subprogram is called, the database recompiles the subprogram automatically. Because the `PLSQL_CODE_TYPE` setting is stored inside the library unit for each subprogram, the automatic recompilation uses this stored setting for code type.

Explicit recompilation does not necessarily use the stored `PLSQL_CODE_TYPE` setting. For the conditions under which explicit recompilation uses stored settings, see "[PL/SQL Units and Compilation Parameters](#)".

12.10.4 Setting Up a New Database for PL/SQL Native Compilation

If you have DBA privileges, you can set up a new database for PL/SQL native compilation by setting the compilation parameter `PLSQL_CODE_TYPE` to `NATIVE`. The performance benefits apply to the PL/SQL packages that Oracle Database supplies, which are used for many database operations.

 **Note:**

If you compile the whole database as `NATIVE`, Oracle recommends that you set `PLSQL_CODE_TYPE` at the system level.

12.10.5 Compiling the Entire Database for PL/SQL Native or Interpreted Compilation

If you have DBA privileges, you can recompile all PL/SQL modules in an existing database to `NATIVE` or `INTERPRETED`, using the `dbmsupgnav.sql` and `dbmsupgin.sql` scripts respectively during the process explained in this section. Before making the conversion, review "[Determining Whether to Use PL/SQL Native Compilation](#)".

 **Note:**

- If you compile the whole database as `NATIVE`, Oracle recommends that you set `PLSQL_CODE_TYPE` at the system level.
- If Database Vault is enabled, then you can run `dbmsupgnav.sql` only if the Database Vault administrator has granted you the `DV_PATCH_ADMIN` role.

During the conversion to native compilation, `TYPE` specifications are not recompiled by `dbmsupgnav.sql` to `NATIVE` because these specifications do not contain executable code.

Package specifications seldom contain executable code so the runtime benefits of compiling to `NATIVE` are not measurable. You can use the `TRUE` command-line parameter with the `dbmsupgnav.sql` script to exclude package specs from recompilation to `NATIVE`, saving time in the conversion process.

When converting to interpreted compilation, the `dbmsupgin.sql` script does not accept any parameters and does not exclude any PL/SQL units.

 **Note:**

The following procedure describes the conversion to native compilation. If you must recompile all PL/SQL modules to interpreted compilation, make these changes in the steps.

- Skip the first step.
- Set the `PLSQL_CODE_TYPE` compilation parameter to `INTERPRETED` rather than `NATIVE`.
- Substitute `dbmsupgin.sql` for the `dbmsupgnv.sql` script.

1. Ensure that a test PL/SQL unit can be compiled. For example:

```
ALTER PROCEDURE my_proc COMPILE PLSQL_CODE_TYPE=NATIVE REUSE SETTINGS;
```

2. Shut down application services, the listener, and the database.

- Shut down all of the Application services including the Forms Processes, Web Servers, Reports Servers, and Concurrent Manager Servers. After shutting down all of the Application services, ensure that all of the connections to the database were terminated.
- Shut down the TNS listener of the database to ensure that no new connections are made.
- Shut down the database in normal or immediate mode as the user `SYS`. See *Oracle Database Administrator's Guide*.

3. Set `PLSQL_CODE_TYPE` to `NATIVE` in the compilation parameter file. If the database is using a server parameter file, then set this after the database has started.

The value of `PLSQL_CODE_TYPE` does not affect the conversion of the PL/SQL units in these steps. However, it does affect all subsequently compiled units, so explicitly set it to the desired compilation type.

4. Start up the database in upgrade mode, using the `UPGRADE` option. For information about `SQL*Plus STARTUP`, see *SQL*Plus User's Guide and Reference*.

5. Run this code to list the invalid PL/SQL units. You can save the output of the query for future reference with the `SQL SPOOL` statement:

```
-- To save the output of the query to a file:
  SPOOL pre_update_invalid.log
SELECT o.OWNER, o.OBJECT_NAME, o.OBJECT_TYPE
FROM DBA_OBJECTS o, DBA_PLSQL_OBJECT_SETTINGS s
WHERE o.OBJECT_NAME = s.NAME AND o.STATUS='INVALID';
-- To stop spooling the output: SPOOL OFF
```

If any Oracle supplied units are invalid, try to validate them by recompiling them. For example:

```
ALTER PACKAGE SYS.DBMS_OUTPUT COMPILE BODY REUSE SETTINGS;
```

If the units cannot be validated, save the spooled log for future resolution and continue.

6. Run this query to determine how many objects are compiled `NATIVE` and `INTERPRETED` (to save the output, use the `SQL SPOOL` statement):

```
SELECT TYPE, PLSQL_CODE_TYPE, COUNT(*)
FROM DBA_PLSQL_OBJECT_SETTINGS
WHERE PLSQL_CODE_TYPE IS NOT NULL
GROUP BY TYPE, PLSQL_CODE_TYPE
ORDER BY TYPE, PLSQL_CODE_TYPE;
```

Any objects with a `NULL` `plsql_code_type` are special internal objects and can be ignored.

7. Run the `$ORACLE_HOME/rdbms/admin/dbmsupgnav.sql` script as the user `SYS` to update the `plsql_code_type` setting to `NATIVE` in the dictionary tables for all PL/SQL units. This process also invalidates the units. Use `TRUE` with the script to exclude package specifications; `FALSE` to include the package specifications.

This update must be done when the database is in `UPGRADE` mode. The script is guaranteed to complete successfully or rollback all the changes.

8. Shut down the database and restart in `NORMAL` mode.
9. Before you run the `utlrp.sql` script, Oracle recommends that no other sessions are connected to avoid possible problems. You can ensure this with this statement:

```
ALTER SYSTEM ENABLE RESTRICTED SESSION;
```

10. Run the `$ORACLE_HOME/rdbms/admin/utlrp.sql` script as the user `SYS`. This script recompiles all the PL/SQL modules using a default degree of parallelism. See the comments in the script for information about setting the degree explicitly.

If for any reason the script is abnormally terminated, rerun the `utlrp.sql` script to recompile any remaining invalid PL/SQL modules.

11. After the compilation completes successfully, verify that there are no invalid PL/SQL units using the query in step 5. You can spool the output of the query to the `post_upgrade_invalid.log` file and compare the contents with the `pre_upgrade_invalid.log` file, if it was created previously.
12. Re-execute the query in step 6. If recompiling with `dbmsupgnav.sql`, confirm that all PL/SQL units, except `TYPE` specifications and package specifications if excluded, are `NATIVE`. If recompiling with `dbmsupgin.sql`, confirm that all PL/SQL units are `INTERPRETED`.
13. Disable the restricted session mode for the database, then start the services that you previously shut down. To disable restricted session mode, use this statement:

```
ALTER SYSTEM DISABLE RESTRICTED SESSION;
```

13

PL/SQL Language Elements

Summarizes the syntax and semantics of PL/SQL language elements and provides links to examples and related topics.

For instructions for reading the syntax diagrams, see *Oracle Database SQL Language Reference*.

Topics

- [ACCESSIBLE BY Clause](#)
- [AGGREGATE Clause](#)
- [Assignment Statement](#)
- [AUTONOMOUS_TRANSACTION Pragma](#)
- [Basic LOOP Statement](#)
- [Block](#)
- [Call Specification](#)
- [CASE Statement](#)
- [CLOSE Statement](#)
- [Collection Method Invocation](#)
- [Collection Variable Declaration](#)
- [Comment](#)
- [COMPILE Clause](#)
- [Constant Declaration](#)
- [CONTINUE Statement](#)
- [COVERAGE Pragma](#)
- [Cursor FOR LOOP Statement](#)
- [Cursor Variable Declaration](#)
- [Datatype Attribute](#)
- [DEFAULT COLLATION Clause](#)
- [DELETE Statement Extension](#)
- [DEPRECATE Pragma](#)
- [DETERMINISTIC Clause](#)
- [Element Specification](#)
- [EXCEPTION_INIT Pragma](#)
- [Exception Declaration](#)
- [Exception Handler](#)

- EXECUTE IMMEDIATE Statement
- EXIT Statement
- Explicit Cursor Declaration and Definition
- Expression
- FETCH Statement
- FOR LOOP Statement
- FORALL Statement
- Formal Parameter Declaration
- Function Declaration and Definition
- GOTO Statement
- IF Statement
- Implicit Cursor Attribute
- INLINE Pragma
- Invoker's Rights and Definer's Rights Clause
- INSERT Statement Extension
- Named Cursor Attribute
- NULL Statement
- OPEN Statement
- OPEN FOR Statement
- PARALLEL_ENABLE Clause
- PIPE ROW Statement
- PIPELINED Clause
- Procedure Declaration and Definition
- RAISE Statement
- Record Variable Declaration
- RESTRICT_REFERENCES Pragma (deprecated)
- RETURN Statement
- RETURNING INTO Clause
- RESULT_CACHE Clause
- %ROWTYPE Attribute
- Scalar Variable Declaration
- SELECT INTO Statement
- SERIALLY_REUSABLE Pragma
- SHARING Clause
- SQL_MACRO Clause
- SQLCODE Function
- SQLERRM Function

- [%TYPE Attribute](#)
- [UDF Pragma](#)
- [UPDATE Statement Extensions](#)
- [WHILE LOOP Statement](#)

**See Also:**

- [PL/SQL Language Fundamentals](#)

13.1 ACCESSIBLE BY Clause

The `ACCESSIBLE BY` clause restricts access to a unit or subprogram by other units.

The **accessor list** explicitly lists those units which may have access. The accessor list can be defined on individual subprograms in a package. This list is checked in addition to the accessor list defined on the package itself (if any). This list may only restrict access to the subprogram – it cannot expand access. This code management feature is useful to prevent inadvertent use of internal subprograms. For example, it may not be convenient or feasible to reorganize a package into two packages: one for a small number of procedures requiring restricted access, and another one for the remaining units requiring public access.

The `ACCESSIBLE BY` clause may appear in the declarations of object types, object type bodies, packages, and subprograms.

The `ACCESSIBLE BY` clause can appear in the following SQL statements:

- [ALTER TYPE Statement](#)
- [CREATE FUNCTION Statement](#)
- [CREATE PROCEDURE Statement](#)
- [CREATE PACKAGE Statement](#)
- [CREATE TYPE Statement](#)
- [CREATE TYPE BODY Statement](#)

Topics

- [Syntax](#)
- [Semantics](#)
- [Usage Notes](#)
- [Examples](#)
- [Related Topics](#)

Syntax

accessible_by_clause ::=

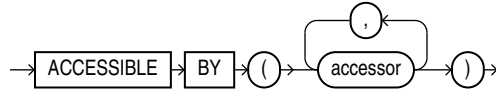

accessor ::=

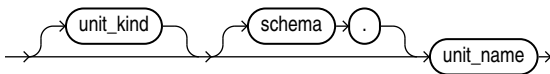

unit_kind ::=

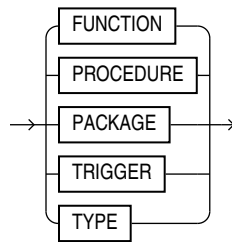

Semantics

accessible_by_clause

accessor

[schema.]unit_name

Specifies a stored PL/SQL unit that can invoke the entity.

Each `accessor` specifies another PL/SQL entity that may access the entity which includes the `ACCESSIBLE BY` clause.

When an `ACCESSIBLE BY` clause appears, only entities named in the clause may access the entity in which the clause appears.

An `accessor` may appear more than once in the `ACCESSIBLE BY` clause.

The `ACCESSIBLE BY` clause can appear only once in the unit declaration.

An entity named in an `accessor` is not required to exist.

When an entity with an `ACCESSIBLE BY` clause is invoked, it imposes an additional access check after all other checks have been performed. These checks are:

- The invoked unit must include an `accessor` with the same `unit_name` and `unit_kind` as the invoking unit.

- If the `accessor` includes a *schema*, the invoking unit must be in that *schema*.
- If the `accessor` does not include a *schema*, the invoker must be from the same schema as the invoked entity.

unit_kind

Specifies if the unit is a `FUNCTION`, `PACKAGE`, `PROCEDURE`, `TRIGGER`, or `TYPE`.

Usage Notes

The *unit_kind* is optional, but it is recommended to specify it to avoid ambiguity when units have the same name. For example, it is possible to define a trigger with the same name as a function.

The `ACCESSIBLE BY` clause allows access only when the call is direct. The check will fail if the access is through static SQL, `DBMS_SQL`, or dynamic SQL.

Any call to the initialization procedure of a package specification or package body will be checked against the *accessor* list of the package specification.

A unit can always access itself. An item in a unit can reference another item in the same unit.

RPC calls to a protected subprogram will always fail, since there is no context available to check the validity of the call, at either compile-time or run-time.

Calls to a protected subprogram from a conditional compilation directive will fail.

Examples

Example 13-1 Restricting Access to Top-Level Procedures in the Same Schema

This example shows that the top-level procedure `top_protected_proc` can only be called by procedure `top_trusted_proc` in the current schema. The user cannot call `top_protected_proc` directly.

Live SQL:

You can view and run this example on Oracle Live SQL at [Restricting Access to Top-Level Procedures in the Same Schema](#)

```
PROCEDURE top_protected_proc
  ACCESSIBLE BY (PROCEDURE top_trusted_proc)
AS
BEGIN
  DBMS_OUTPUT.PUT_LINE('Executed top_protected_proc.');
```

```
PROCEDURE top_trusted_proc AS
BEGIN
  DBMS_OUTPUT.PUT_LINE('top_trusted_proc calls top_protected_proc');
  top_protected_proc;
END;
```

```
EXEC top_trusted_proc;
top_trusted_proc calls top_protected_proc
Executed top_protected_proc.
```

```
EXEC top_protected_proc;
BEGIN top_protected_proc; END;
```

```
PLS-00904: insufficient privilege to access object TOP_PROTECTED_PROC
```

Example 13-2 Restricting Access to a Unit Name of Any Kind

This example shows that if the PL/SQL *unit_kind* is not specified in the `ACCESSIBLE BY` clause, then a call from any unit kind is allowed if the unit name matches. There is no compilation error if the *unit_kind* specified in the `ACCESSIBLE BY` clause does not match any existing objects. It is possible to define a trigger with the same name as a function. It is recommended to specify the *unit_kind*.

Live SQL:

You can view and run this example on Oracle Live SQL at [Restricting Access to a Unit Name of Any Kind](#)

```
PROCEDURE protected_proc2
  ACCESSIBLE BY (top_trusted_f)
AS
BEGIN
  DBMS_OUTPUT.PUT_LINE('Executed protected_proc2.');
```

```
END;
```

```
FUNCTION top_protected_f RETURN NUMBER
  ACCESSIBLE BY (TRIGGER top_trusted_f ) AS
BEGIN
  RETURN 0.5;
END top_protected_f;
```

```
FUNCTION top_trusted_f RETURN NUMBER AUTHID DEFINER IS
  FUNCTION g RETURN NUMBER DETERMINISTIC IS
  BEGIN
    RETURN 0.5;
  END g;
BEGIN
  protected_proc2;
  RETURN g() - DBMS_RANDOM.VALUE();
END top_trusted_f;
```

```
SELECT top_trusted_f FROM DUAL;
       .381773176

1 row selected.
```

Executed protected_proc2.

Example 13-3 Restricting Access to a Stored Procedure

This example shows a package procedure that can only be called by top_trusted_proc procedure. The `ACCESSIBLE BY` clause of a subprogram specification and body must match. A compilation error is raised if a call is made to an existing procedure with an `ACCESSIBLE BY` clause that does not include this procedure in its accessor list.

Live SQL:

You can view and run this example on Oracle Live SQL at [Restricting Access to a Stored Procedure](#)

```
CREATE OR REPLACE PACKAGE protected_pkg
AS
  PROCEDURE public_proc;
  PROCEDURE private_proc ACCESSIBLE BY (PROCEDURE top_trusted_proc);
END;

CREATE OR REPLACE PACKAGE BODY protected_pkg
AS
  PROCEDURE public_proc AS
  BEGIN
    DBMS_OUTPUT.PUT_LINE('Executed protected_pkg.public_proc');
  END;
  PROCEDURE private_proc ACCESSIBLE BY (PROCEDURE top_trusted_proc) AS
  BEGIN
    DBMS_OUTPUT.PUT_LINE('Executed protected_pkg.private_proc');
  END;
END;

CREATE OR REPLACE PROCEDURE top_trusted_proc
AS
  BEGIN
    DBMS_OUTPUT.PUT_LINE('top_trusted_proc calls protected_pkg.private_proc
');
    protected_pkg.private_proc;
  END;
```

Procedure created.

```
EXEC top_trusted_proc;
top_trusted_proc calls protected_pkg.private_proc
Executed protected_pkg.private_proc
```

```
EXEC protected_pkg.private_proc
PLS-00904: insufficient privilege to access object PRIVATE_PROC
```

Related Topics

In this chapter:

- [Function Declaration and Definition](#)
- [Procedure Declaration and Definition](#)

In other chapters:

- [Nested, Package, and Standalone Subprograms](#)
- [Subprogram Properties](#)
- [Package Writing Guidelines](#)

13.2 AGGREGATE Clause

Identifies the function as an **aggregate function**, or one that evaluates a group of rows and returns a single row.

You can specify aggregate functions in the select list, `HAVING` clause, and `ORDER BY` clause.

When you specify a user-defined aggregate function in a query, you can treat it as an **analytic function** (one that operates on a query result set). To do so, use the `OVER analytic_clause` syntax available for SQL analytic functions.

The `AGGREGATE` clause can appear in the [CREATE FUNCTION Statement](#).

Topics

- [Syntax](#)
- [Semantics](#)
- [Examples](#)
- [Related Topics](#)

Syntax

aggregate_clause ::=

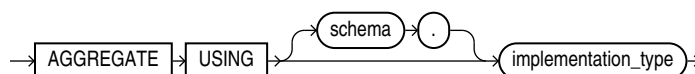

Semantics

aggregate_clause

AGGREGATE USING

Specify the name of the implementation type of the function.

[schema.] implementation_type

The implementation type must be an ADT containing the implementation of the `ODCIAggregate` subprograms. If you do not specify `schema`, then the database assumes that the implementation type is in your schema.

Restriction on AGGREGATE USING

You cannot specify the `aggregate_clause` for a nested function.

If you specify this clause, then you can specify only one input argument for the function.

Examples

- [Example 12-33](#), "Pipelined Table Function as Aggregate Function"

Related Topics

In this chapter:

- [Function Declaration and Definition](#)

In other books:

- *Oracle Database SQL Language Reference* for syntax and semantics of analytic functions
- *Oracle Database Data Cartridge Developer's Guide* for more information about user-defined aggregate functions
- *Oracle Database Data Cartridge Developer's Guide* for information about ODCI subprograms

13.3 Assignment Statement

The assignment statement sets the value of a data item to a valid value.

Topics

- [Syntax](#)
- [Semantics](#)
- [Examples](#)
- [Related Topics](#)

Syntax

`assignment_statement ::=`

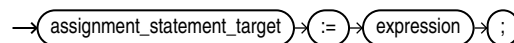

(`expression ::=`)

assignment_statement_target ::=

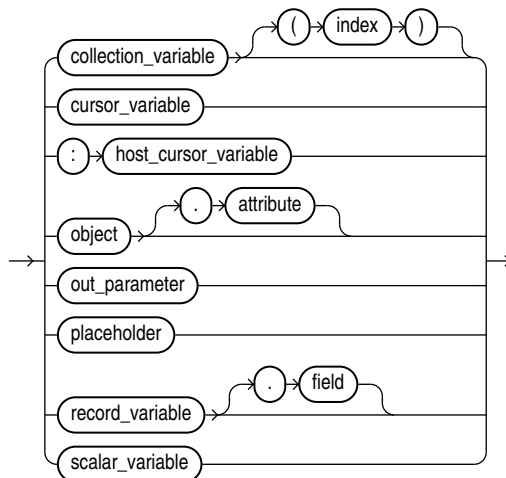

placeholder ::=

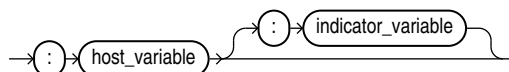

Semantics

assignment_statement

expression

Expression whose value is to be assigned to *assignment_statement_target*.

expression and *assignment_statement_target* must have compatible data types.

 **Note:**
Collections with elements of the same type might not have the same data type. For the syntax of collection type definitions, see "[Collection Variable Declaration](#)".

assignment_statement_target

Data item to which the value of *expression* is to be assigned.

collection_variable

Name of a collection variable.

index

Index of an element of *collection_variable*. Without *index*, the entire collection variable is the assignment statement target.

index must be a numeric expression whose data type either is `PLS_INTEGER` or can be implicitly converted to `PLS_INTEGER` (for information about the latter, see "[Predefined PLS_INTEGER Subtypes](#)").

cursor_variable

Name of a cursor variable.

:host_cursor_variable

Name of a cursor variable declared in a PL/SQL host environment and passed to PL/SQL as a bind variable. Do not put space between the colon (:) and *host_cursor_variable*.

The data type of a host cursor variable is compatible with the return type of any PL/SQL cursor variable.

object

Name of an instance of an abstract data type (ADT).

attribute

Name of an attribute of *object*. Without *attribute*, the entire ADT is the assignment statement target.

out_parameter

Name of a formal `OUT` or `IN OUT` parameter of the subprogram in which the assignment statement appears.

record_variable

Name of a record variable.

field

Name of a field of *record_variable*. Without *field*, the entire record variable is the assignment statement target.

scalar_variable

Name of a PL/SQL scalar variable.

placeholder***:host_variable***

Name of a variable declared in a PL/SQL host environment and passed to PL/SQL as a bind variable. Do not put space between the colon (:) and *host_variable*.

:indicator_variable

Name of an indicator variable declared in a PL/SQL host environment and passed to PL/SQL as a bind variable. (An indicator variable indicates the value or condition of its associated host variable. For example, in the Oracle Precompiler environment, an indicator variable can detect null or truncated value in an output host variable.) Do not put space between *host_variable* and the colon (:) or between the colon and *indicator_variable*. This is correct:

```
:host_variable:indicator_variable
```

Examples

- [Example 2-24](#), "Assigning Values to Variables with Assignment Statement"
- [Example 2-27](#), "Assigning Value to BOOLEAN Variable"
- [Example 5-10](#), "Data Type Compatibility for Collection Assignment"

Related Topics

In this chapter:

- ["Expression"](#)
- ["FETCH Statement"](#)
- ["SELECT INTO Statement"](#)

In other chapters:

- ["Assigning Values to Variables"](#)
- ["Assigning Values to Collection Variables"](#)
- ["Assigning Values to Record Variables"](#)

13.4 AUTONOMOUS_TRANSACTION Pragma

The `AUTONOMOUS_TRANSACTION` pragma marks a routine as **autonomous**; that is, independent of the main transaction.

In this context, a **routine** is one of these:

- Schema-level (not nested) anonymous PL/SQL block
- Standalone, package, or nested subprogram
- Method of an ADT
- Noncompound trigger

Topics

- [Syntax](#)
- [Examples](#)
- [Related Topics](#)

Syntax

```
autonomous_trans_pragma ::=
```

```
→ PRAGMA → AUTONOMOUS_TRANSACTION → ;
```

Examples

- [Example 6-43](#), "Declaring Autonomous Function in Package"

- [Example 6-44](#), "Declaring Autonomous Standalone Procedure"
- [Example 6-45](#), "Declaring Autonomous PL/SQL Block"
- [Example 6-46](#), "Autonomous Trigger Logs INSERT Statements"
- [Example 6-47](#), "Autonomous Trigger Uses Native Dynamic SQL for DDL"
- [Example 6-48](#), "Invoking Autonomous Function"

Related Topics

- [Pragmas](#)
- [Autonomous Transactions](#)

13.5 Basic LOOP Statement

With each iteration of the basic `LOOP` statement, its statements run and control returns to the top of the loop. The `LOOP` statement ends when a statement inside the loop transfers control outside the loop or raises an exception.

Topics

- [Syntax](#)
- [Semantics](#)
- [Examples](#)
- [Related Topics](#)

Syntax

basic_loop_statement ::=

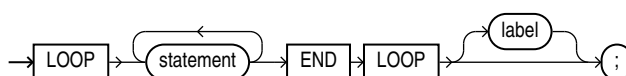

(statement ::=)

Semantics

basic_loop_statement

statement

To prevent an infinite loop, at least one statement must transfer control outside the loop. The statements that can transfer control outside the loop are:

- ["CONTINUE Statement"](#) (when it transfers control to the next iteration of an enclosing labeled loop)
- ["EXIT Statement"](#)
- ["GOTO Statement"](#)
- ["RAISE Statement"](#)

label

A label that identifies *basic_loop_statement* (see "statement ::= " and "label").
CONTINUE, EXIT, and GOTO statements can reference this label.

Labels improve readability, especially when LOOP statements are nested, but only if you ensure that the label in the END LOOP statement matches a label at the beginning of the same LOOP statement (the compiler does not check).

Examples

- [Example 1-2](#), "Processing Query Result Rows One at a Time"
- [Example 4-9](#), "Basic LOOP Statement with EXIT Statement"
- [Example 4-10](#), "Basic LOOP Statement with EXIT WHEN Statement"
- [Example 4-11](#), "Nested, Labeled Basic LOOP Statements with EXIT WHEN Statements"
- [Example 4-13](#), "CONTINUE Statement in Basic LOOP Statement"
- [Example 4-14](#), "CONTINUE WHEN Statement in Basic LOOP Statement"

Related Topics

In this chapter:

- ["Cursor FOR LOOP Statement"](#)
- ["FOR LOOP Statement"](#)
- ["WHILE LOOP Statement"](#)

In other chapters:

- ["Basic LOOP Statement"](#)

13.6 Block

The **block**, which groups related declarations and statements, is the basic unit of a PL/SQL source program.

It has an optional declarative part, a required executable part, and an optional exception-handling part. Declarations are local to the block and cease to exist when the block completes execution. Blocks can be nested.

An anonymous block is an executable statement.

Topics

- [Syntax](#)
- [Semantics](#)
- [Examples](#)
- [Related Topics](#)

Syntax

plsql_block ::=

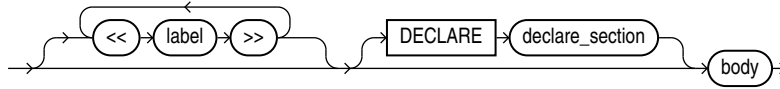

(body ::=)

declare_section ::=

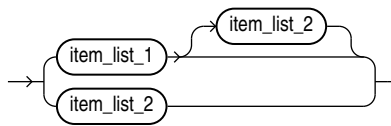

(item_list_2 ::=)

item_list_1 ::=

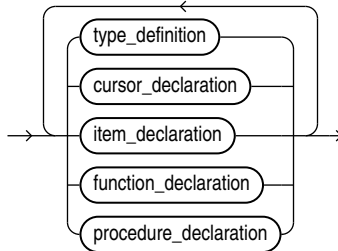

(cursor_declaration ::=, function_declaration ::=, item_declaration ::=, procedure_declaration ::=, type_definition ::=)

item_list_2 ::=

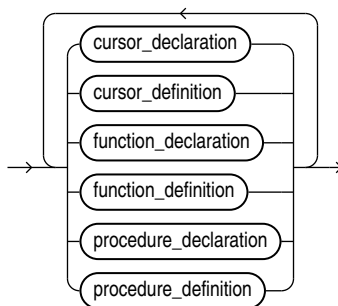

(*cursor_declaration ::=*, *cursor_definition ::=*, *function_declaration ::=*,
function_definition ::=, *procedure_declaration ::=*, *procedure_definition ::=*)

type_definition ::=

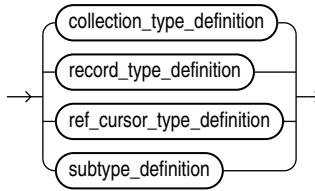

(*collection_type_definition ::=*, *record_type_definition ::=*,
ref_cursor_type_definition ::=, *subtype_definition ::=*)

subtype_definition ::=

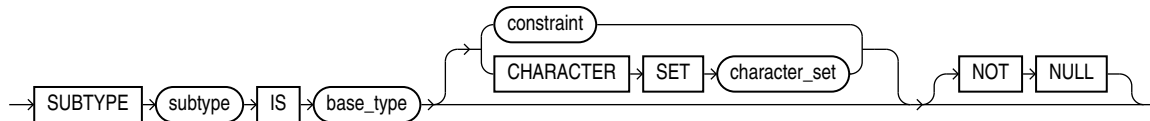

constraint ::=

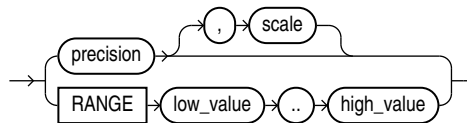

item_declaration ::=

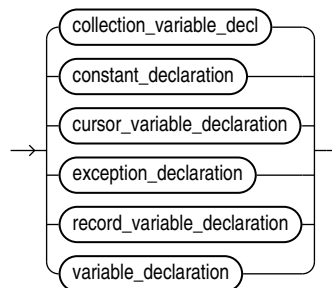

(*collection_variable_decl ::=*, *constant_declaration ::=*, *cursor_declaration ::=*,
cursor_variable_declaration ::=, *exception_declaration ::=*,
record_variable_declaration ::=, *variable_declaration ::=*)

body ::=

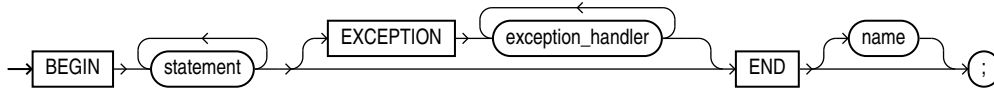

(exception_handler ::=)

statement ::=

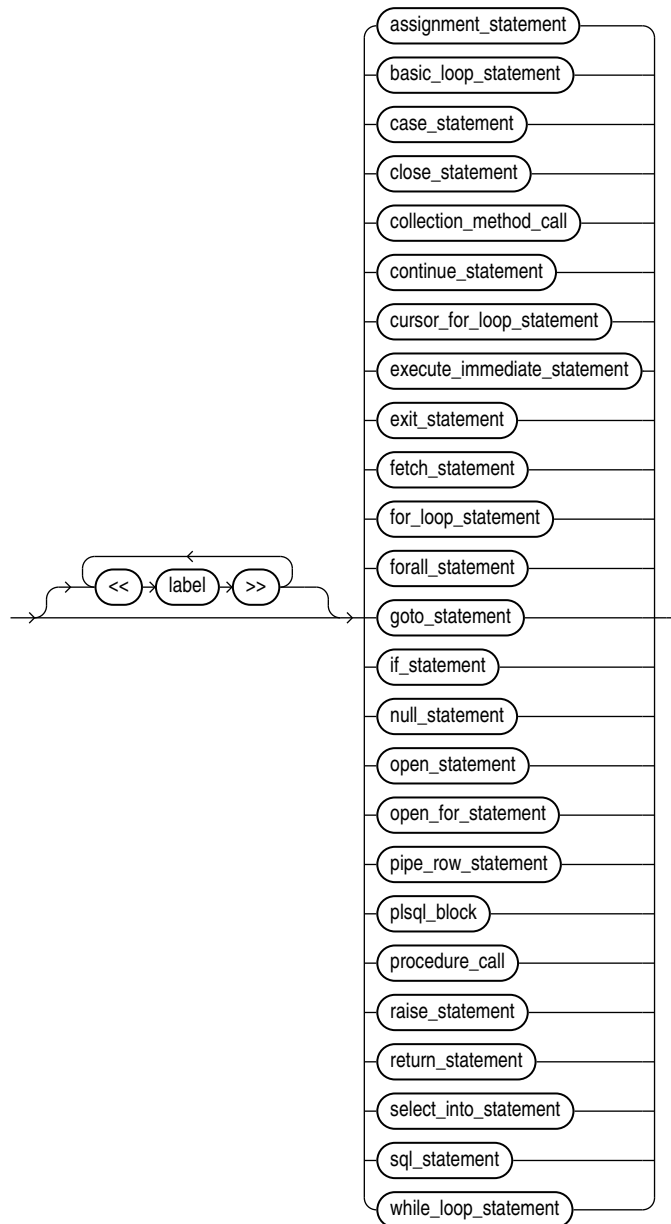

(plsql_block ::=, procedure_call ::=, sql_statement ::=)

procedure_call ::=

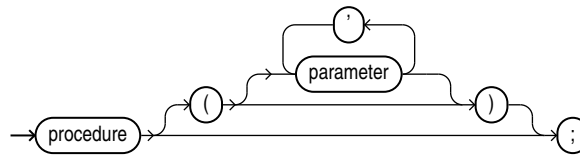

sql_statement ::=

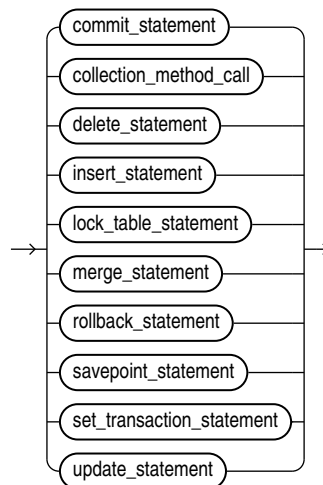

Semantics

plsql_block

label

Undeclared identifier, unique for the block.

DECLARE

Starts the declarative part of the block.

declare_section

Contains local declarations, which exist only in the block and its sub-blocks and are not visible to enclosing blocks.

Restrictions on *declare_section*

- A *declare_section* in *create_package*, *create_package_body*, or *compound_trigger_block* cannot include PRAGMA AUTONOMOUS_TRANSACTION.
- A *declare_section* in *trigger_body* or *tps_body* cannot declare variables of the data type LONG or LONG RAW.

 **See Also:**

- "[CREATE PACKAGE Statement](#)" for more information about `create_package`
- "[CREATE PACKAGE BODY Statement](#)" for more information about `create_package_body`
- "[CREATE TRIGGER Statement](#)" for more information about `compound_trigger_block`, `trigger_body`, and `tps_body`

subtype_definition

Static expressions can be used in subtype declarations. See [Static Expressions](#) for more information.

subtype

Name of the user-defined subtype that you are defining.

base_type

Base type of the subtype that you are defining. *base_type* can be any scalar or user-defined PL/SQL datatype specifier such as CHAR, DATE, or RECORD.

CHARACTER SET *character_set*

Specifies the character set for a subtype of a character data type.

Restriction on CHARACTER SET *character_set*

Do not specify this clause if *base_type* is not a character data type.

NOT NULL

Imposes the NOT NULL constraint on data items declared with this subtype. For information about this constraint, see "[NOT NULL Constraint](#)".

constraint

Specifies a constraint for a subtype of a numeric data type.

Restriction on *constraint*

Do not specify *constraint* if *base_type* is not a numeric data type.

precision

Specifies the precision for a constrained subtype of a numeric data type.

Restriction on *precision*

Do not specify *precision* if *base_type* cannot specify precision.

scale

Specifies the scale for a constrained subtype of a numeric data type.

Restriction on *scale*

Do not specify *scale* if *base_type* cannot specify scale.

RANGE *low_value* .. *high_value*

Specifies the range for a constrained subtype of a numeric data type. The *low_value* and *high_value* must be numeric literals.

Restriction on RANGE *high_value* .. *low_value*

Specify this clause only if *base_type* is PLS_INTEGER or a subtype of PLS_INTEGER (either predefined or user-defined). (For a summary of the predefined subtypes of PLS_INTEGER, see [Table 3-3](#). For information about user-defined subtypes with ranges, see "[Constrained Subtypes](#)".)

body**BEGIN**

Starts the executable part of the block, which contains executable statements.

EXCEPTION

Starts the exception-handling part of the block. When PL/SQL raises an exception, normal execution of the block stops and control transfers to the appropriate *exception_handler*. After the exception handler completes, execution resumes with the statement following the block. For more information about exception-handling, see [PL/SQL Error Handling](#).

exception_handler

See "[Exception Handler](#)".

END

Ends the block.

name

The name of the block to which END applies—a label, function name, procedure name, or package name.

statement***label***

Undeclared identifier, unique for the statement.

assignment_statement

See "[Assignment Statement](#)".

basic_loop_statement

See "[Basic LOOP Statement](#)".

case_statement

See "[CASE Statement](#)".

close_statement

See "[CLOSE Statement](#)".

collection_method_call

Invocation of one of these collection methods, which are procedures:

- DELETE
- EXTEND
- TRIM

For syntax, see ["Collection Method Invocation"](#).

continue_statement

See ["CONTINUE Statement"](#).

cursor_for_loop_statement

See ["Cursor FOR LOOP Statement"](#).

execute_immediate_statement

See ["EXECUTE IMMEDIATE Statement"](#).

exit_statement

See ["EXIT Statement"](#).

fetch_statement

See ["FETCH Statement"](#).

for_loop_statement

See ["FOR LOOP Statement"](#).

forall_statement

See ["FORALL Statement"](#).

goto_statement

See ["GOTO Statement"](#).

if_statement

See ["IF Statement"](#).

null_statement

See ["NULL Statement"](#).

open_statement

See ["OPEN Statement"](#).

open_for_statement

See ["OPEN FOR Statement"](#).

pipe_row_statement

See ["PIPE ROW Statement"](#).

Restriction on *pipe_row_statement*

This statement can appear only in the body of a pipelined table function; otherwise, PL/SQL raises an exception.

raise_statement

See ["RAISE Statement"](#).

return_statement

See ["RETURN Statement"](#).

select_into_statement

See ["SELECT INTO Statement"](#).

while_loop_statement

See ["WHILE LOOP Statement"](#).

procedure_call***procedure***

Name of the procedure that you are invoking.

parameter [, parameter]...

List of actual parameters for the procedure that you are invoking. The data type of each actual parameter must be compatible with the data type of the corresponding formal parameter. The mode of the formal parameter determines what the actual parameter can be:

Formal Parameter Mode	Actual Parameter
IN	Constant, initialized variable, literal, or expression
OUT	Variable whose data type is not defined as NOT NULL
IN OUT	Variable (typically, it is a string buffer or numeric accumulator)

If the procedure specifies a default value for a parameter, you can omit that parameter from the parameter list. If the procedure has no parameters, or specifies a default value for every parameter, you can either omit the parameter list or specify an empty parameter list.

**See Also:**

["Positional, Named, and Mixed Notation for Actual Parameters"](#)

sql_statement***commit_statement***

SQL COMMIT statement. For syntax, see *Oracle Database SQL Language Reference*.

delete_statement

SQL DELETE statement. For syntax, see *Oracle Database SQL Language Reference*. See also ["DELETE Statement Extension"](#).

insert_statement

SQL `INSERT` statement. For syntax, see *Oracle Database SQL Language Reference*. See also "[INSERT Statement Extension](#)".

lock_table_statement

SQL `LOCK TABLE` statement. For syntax, see *Oracle Database SQL Language Reference*.

merge_statement

SQL `MERGE` statement. For syntax, see *Oracle Database SQL Language Reference*.

rollback_statement

SQL `ROLLBACK` statement. For syntax, see *Oracle Database SQL Language Reference*.

savepoint_statement

SQL `SAVEPOINT` statement. For syntax, see *Oracle Database SQL Language Reference*.

set_transaction_statement

SQL `SET TRANSACTION` statement. For syntax, see *Oracle Database SQL Language Reference*.

update_statement

SQL `UPDATE` statement. For syntax, see *Oracle Database SQL Language Reference*. See also "[UPDATE Statement Extensions](#)".

Examples

- [Example 1-1](#), "PL/SQL Block Structure"
- [Example 2-23](#), "Block with Multiple and Duplicate Labels"
- [Example 4-30](#), "Incorrect Label Placement"

Related Topics

In this chapter:

- ["Comment"](#)

In other chapters:

- ["Blocks"](#)
- ["Identifiers"](#)
- ["Pragmas"](#)
- ["PL/SQL Data Types"](#)
- ["User-Defined PL/SQL Subtypes"](#)

13.7 Call Specification

A **call specification** declares a Java method or a C language subprogram so that it can be invoked from PL/SQL. You can also use the SQL `CALL` statement to invoke such a method or subprogram. The call specification tells the database which Java method, or which named

subprogram in which shared library, to invoke when an invocation is made. It also tells the database what type conversions to make for the arguments and return value.

A **call specification** can appear in the following SQL statements:

- ALTER TYPE Statement
- CREATE FUNCTION Statement
- CREATE PROCEDURE Statement
- CREATE TYPE Statement
- CREATE TYPE BODY Statement

Topics

- Syntax
- Semantics
- Examples
- Related Topics

Prerequisites

To invoke a call specification, you may need additional privileges, for example, EXECUTE privileges on a C library for a C call specification.

Syntax

call_spec ::=

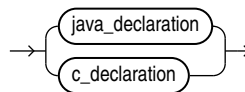

java_declaration ::=



c_declaration ::=

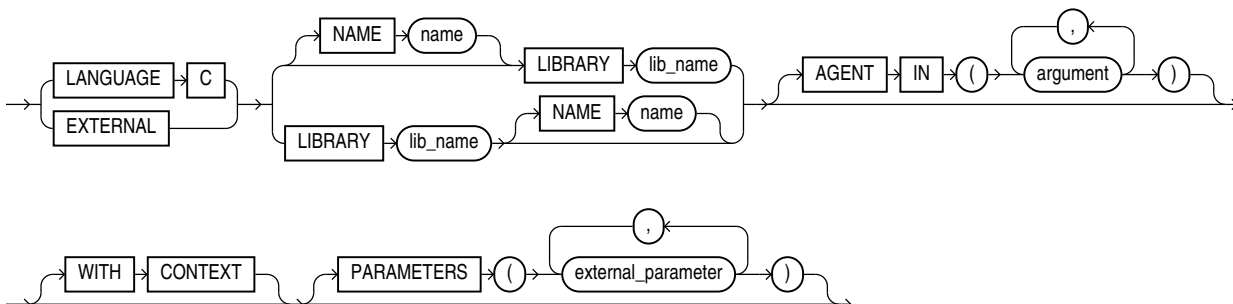

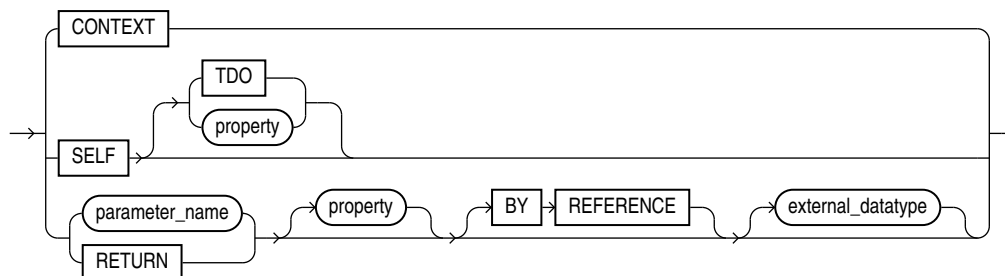
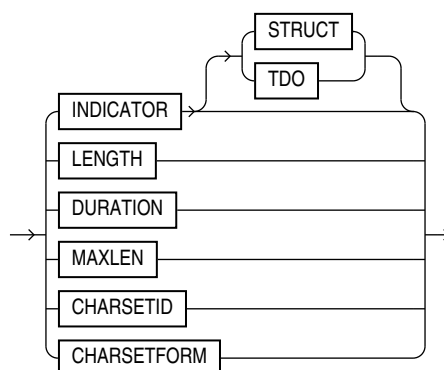
external_parameter ::=**property ::=****Semantics****call_spec**

Maps a C procedure or Java method name, parameter types, and return type to their SQL counterparts.

Call specifications can appear in PL/SQL standalone subprograms, package specifications and bodies, and type specifications and bodies. They cannot appear inside PL/SQL blocks.

java_declaration**string**

Identifies the Java implementation of the method.

c_declaration**LIBRARY lib_name**

Identifies a library created by the "CREATE LIBRARY Statement".

EXTERNAL

Deprecated way of declaring a C subprogram, supported only for backward compatibility. Use `EXTERNAL` in a C call specification if it contains defaulted arguments or constrained PL/SQL types, otherwise use the `LANGUAGE C` syntax.

Examples

Example 13-4 External Function Example

The hypothetical following statement creates a PL/SQL standalone function `get_val` that registers the C subprogram `c_get_val` as an external function. (The parameters have been omitted from this example.)

```
CREATE FUNCTION get_val
  ( x_val IN NUMBER,
    y_val IN NUMBER,
    image IN LONG RAW )
  RETURN BINARY_INTEGER AS LANGUAGE C
  NAME "c_get_val"
  LIBRARY c_utils
  PARAMETERS (...);
```

Related Topics

In this chapter:

- [Function Declaration and Definition](#)
- [Procedure Declaration and Definition](#)

In other chapters:

- [CREATE LIBRARY Statement](#)
- [External Subprograms](#)

In other books:

- *Oracle Database SQL Language Reference* for information about the `CALL` statement
- *Oracle Database Development Guide* for information about restrictions on user-defined functions that are called from SQL statements
- *Oracle Database Java Developer's Guide* to learn how to write Java call specifications
- *Oracle Database Development Guide* to learn how to write C call specifications

13.8 CASE Statement

The `CASE` statement chooses from a sequence of conditions and runs a corresponding statement.

The simple `CASE` statement evaluates a single expression and compares it to several potential values.

The searched `CASE` statement evaluates multiple Boolean expressions and chooses the first one whose value is `TRUE`.

Topics

- [Syntax](#)
- [Semantics](#)
- [Examples](#)
- [Related Topics](#)

Syntax

simple_case_statement ::=

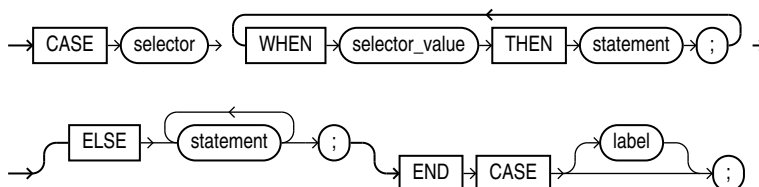

searched_case_statement ::=

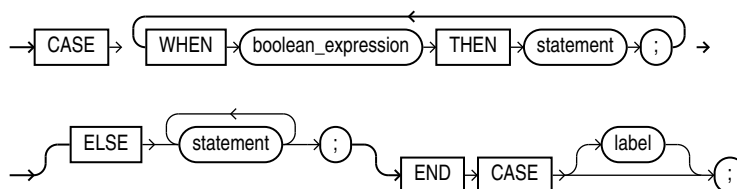

(*boolean_expression ::=*, *statement ::=*)

Semantics

simple_case_statement

selector

Expression whose value is evaluated once and used to select one of several alternatives. *selector* can have any PL/SQL data type except BLOB, BFILE, or a user-defined type.

WHEN *selector_value* THEN *statement*

selector_value can be an expression of any PL/SQL type except BLOB, BFILE, or a user-defined type.

The *selector_values* are evaluated sequentially. If the value of a *selector_value* equals the value of *selector*, then the *statement* associated with that *selector_value* runs, and the CASE statement ends. Subsequent *selector_values* are not evaluated.

▲ Caution:

A *statement* can modify the database and invoke nondeterministic functions. There is no fall-through mechanism, as there is in the C `switch` statement.

ELSE statement [statement]...

The *statements* run if and only if no *selector_value* has the same value as *selector*.

Without the `ELSE` clause, if no *selector_value* has the same value as *selector*, the system raises the predefined exception `CASE_NOT_FOUND`.

label

A label that identifies the statement (see "[statement ::=](#)" and "[label](#)").

searched_case_statement**WHEN boolean_expression THEN statement**

The *boolean_expression*s are evaluated sequentially. If the value of a *boolean_expression* is `TRUE`, the *statement* associated with that *boolean_expression* runs, and the `CASE` statement ends. Subsequent *boolean_expression*s are not evaluated.

▲ Caution:

A *statement* can modify the database and invoke nondeterministic functions. There is no fall-through mechanism, as there is in the C `switch` statement.

ELSE statement [statement]...

The *statements* run if and only if no *boolean_expression* has the value `TRUE`.

Without the `ELSE` clause, if no *boolean_expression* has the value `TRUE`, the system raises the predefined exception `CASE_NOT_FOUND`.

label

A label that identifies the statement (see "[statement ::=](#)" and "[label](#)").

Examples

- [Example 3-2](#), "Printing BOOLEAN Values"
- [Example 4-6](#), "Simple CASE Statement"
- [Example 4-7](#), "Searched CASE Statement"

Related Topics

In this chapter:

- ["IF Statement"](#)

In other chapters:

- ["CASE Expressions"](#)
- ["Conditional Selection Statements"](#)
- ["Simple CASE Statement"](#)
- ["Searched CASE Statement"](#)

See Also:

- *Oracle Database SQL Language Reference* for information about the `NULLIF` function
- *Oracle Database SQL Language Reference* for information about the `COALESCE` function

13.9 CLOSE Statement

The `CLOSE` statement closes a named cursor, freeing its resources for reuse.

After closing an explicit cursor, you can reopen it with the `OPEN` statement. You must close an explicit cursor before reopening it.

After closing a cursor variable, you can reopen it with the `OPEN FOR` statement. You need not close a cursor variable before reopening it.

Topics

- [Syntax](#)
- [Semantics](#)
- [Examples](#)
- [Related Topics](#)

Syntax

close_statement ::=

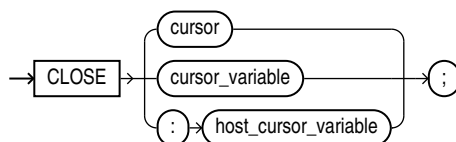

Semantics

close_statement

cursor

Name of an open explicit cursor.

cursor_variable

Name of an open cursor variable.

:host_cursor_variable

Name of a cursor variable declared in a PL/SQL host environment and passed to PL/SQL as a bind variable. Do not put space between the colon (:) and *host_cursor_variable*.

Examples

- [Example 6-6](#), "FETCH Statements Inside LOOP Statements"

Related Topics

In this chapter:

- ["FETCH Statement"](#)
- ["OPEN Statement"](#)
- ["OPEN FOR Statement"](#)

In other chapters:

- ["Opening and Closing Explicit Cursors"](#)
- ["Opening and Closing Cursor Variables"](#)

13.10 Collection Method Invocation

A collection method is a PL/SQL subprogram that either returns information about a collection or operates on a collection.

Topics

- [Syntax](#)
- [Semantics](#)
- [Examples](#)
- [Related Topics](#)

Syntax

collection_method_call ::=

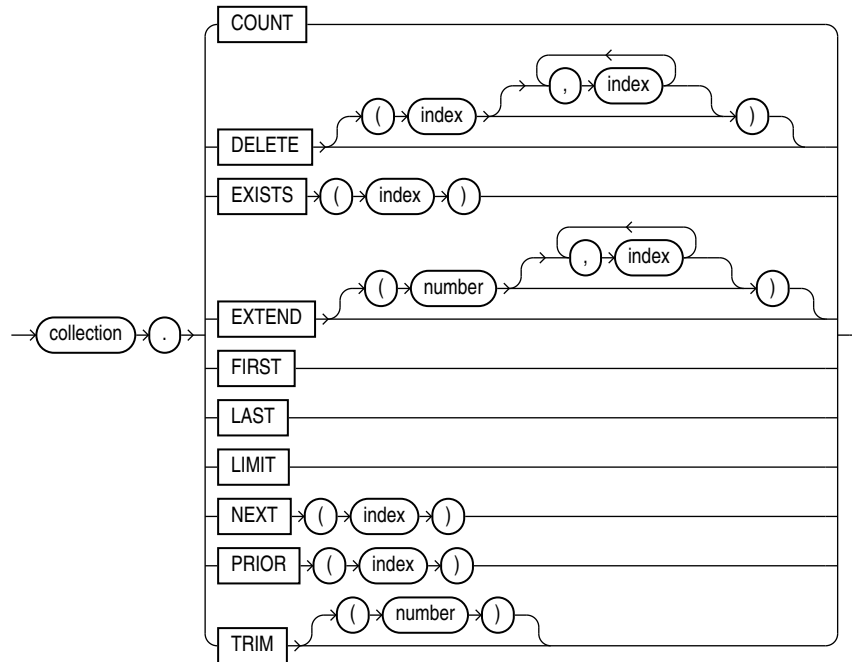

Semantics

collection_method_call

collection

Name of the collection whose method you are invoking.

COUNT

Function that returns the number of elements in the collection, explained in "[COUNT Collection Method](#)".

DELETE

Procedure that deletes elements from the collection, explained in "[DELETE Collection Method](#)".

Restriction on DELETE

If *collection* is a varray, you cannot specify indexes with DELETE.

index

Numeric expression whose data type either is `PLS_INTEGER` or can be implicitly converted to `PLS_INTEGER` (for information about the latter, see "s").

EXISTS

Function that returns `TRUE` if the *index*th element of the collection exists and `FALSE` otherwise, explained in "[EXISTS Collection Method](#)".

EXTEND

Procedure that adds elements to the end of the collection, explained in "[EXTEND Collection Method](#)".

Restriction on EXTEND

You cannot use `EXTEND` if *collection* is an associative array.

FIRST

Function that returns the first index in the collection, explained in "[FIRST and LAST Collection Methods](#)".

LAST

Function that returns the last index in the collection, explained in "[FIRST and LAST Collection Methods](#)".

LIMIT

Function that returns the maximum number of elements that the collection can have. If the collection has no maximum size, then `LIMIT` returns `NULL`. For an example, see "[LIMIT Collection Method](#)".

NEXT

Function that returns the index of the succeeding existing element of the collection, if one exists. Otherwise, `NEXT` returns `NULL`. For more information, see "[PRIOR and NEXT Collection Methods](#)".

PRIOR

Function that returns the index of the preceding existing element of the collection, if one exists. Otherwise, `NEXT` returns `NULL`. For more information, see "[PRIOR and NEXT Collection Methods](#)".

TRIM

Procedure that deletes elements from the end of a collection, explained in "[TRIM Collection Method](#)".

Restriction on TRIM

You cannot use `TRIM` if *collection* is an associative array.

number

Number of elements to delete from the end of a collection. **Default:** one.

Examples

- [Example 5-19](#), "DELETE Method with Nested Table"
- [Example 5-20](#), "DELETE Method with Associative Array Indexed by String"
- [Example 5-21](#), "TRIM Method with Nested Table"
- [Example 5-22](#), "EXTEND Method with Nested Table"
- [Example 5-23](#), "EXISTS Method with Nested Table"
- [Example 5-24](#), "FIRST and LAST Values for Associative Array Indexed by `PLS_INTEGER`"

- [Example 5-25](#), "FIRST and LAST Values for Associative Array Indexed by String"
- [Example 5-26](#), "Printing Varray with FIRST and LAST in FOR LOOP"
- [Example 5-27](#), "Printing Nested Table with FIRST and LAST in FOR LOOP"
- [Example 5-28](#), "COUNT and LAST Values for Varray"
- [Example 5-29](#), "COUNT and LAST Values for Nested Table"
- [Example 5-30](#), "LIMIT and COUNT Values for Different Collection Types"
- [Example 5-31](#), "PRIOR and NEXT Methods"
- [Example 5-32](#), "Printing Elements of Sparse Nested Table"

Related Topics

In this chapter:

- ["Collection Variable Declaration"](#)

In other chapters:

- ["Collection Methods"](#)

13.11 Collection Variable Declaration

A **collection variable** is a composite variable whose internal components, called elements, have the same data type.

The value of a collection variable and the values of its elements can change.

You reference an entire collection by its name. You reference a collection element with the syntax `collection(index)`.

PL/SQL has three kinds of collection types:

- Associative array (formerly called *PL/SQL table* or *index-by table*)
- Variable-size array (varray)
- Nested table

An associative array can be indexed by either a string type or `PLS_INTEGER`. Varrays and nested tables are indexed by integers.

You can create a collection variable in either of these ways:

- Define a collection type and then declare a variable of that type.
- Use `%TYPE` to declare a collection variable of the same type as a previously declared collection variable.

Note:

This topic applies to collection types that you define inside a PL/SQL block or package, which differ from standalone collection types that you create with the "CREATE TYPE Statement".

In a PL/SQL block or package, you can define all three collection types. With the CREATE TYPE statement, you can create nested table types and VARRAY types, but not associative array types.

Topics

- [Syntax](#)
- [Semantics](#)
- [Examples](#)
- [Related Topics](#)

Syntax

collection_type_definition ::=

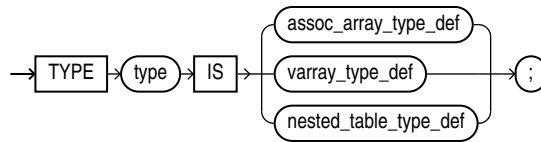

assoc_array_type_def ::=

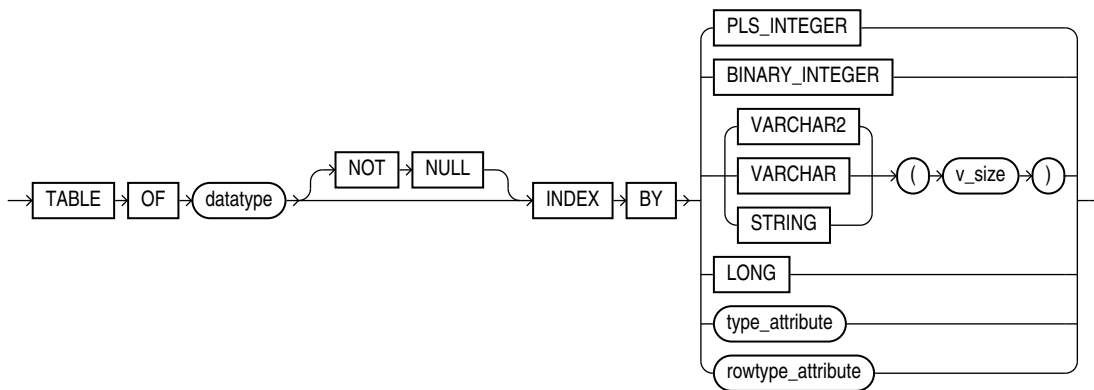

(datatype ::=, rowtype_attribute ::=, type_attribute ::=)

varray_type_def ::=

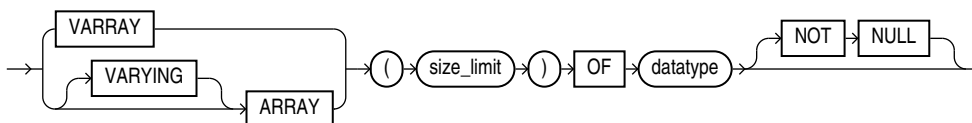

(*datatype* ::=)

nested_table_type_def ::=

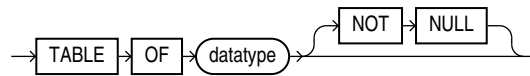

(*datatype* ::=)

collection_variable_decl ::=

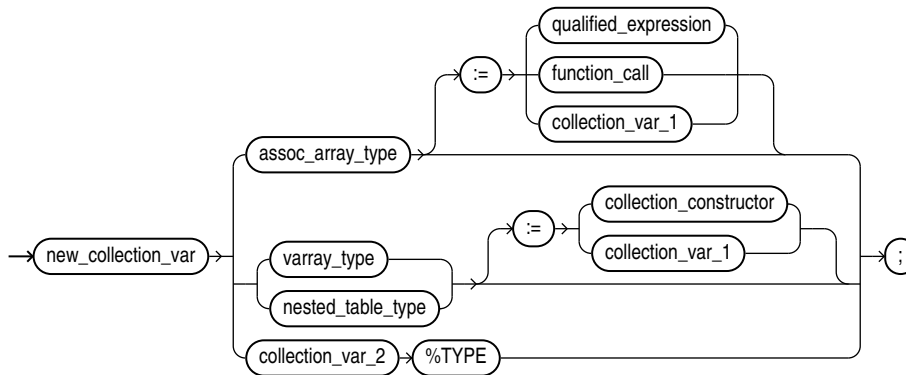

(*collection_constructor* ::=, *function_call* ::=, *qualified_expression* ::=)

Semantics

collection_type_definition

type

Name of the collection type that you are defining.

assoc_array_type_def

Type definition for an associative array.

Restriction on assoc_array_type_def

Can appear only in the declarative part of a block, subprogram, package specification, or package body.

datatype

Data type of the elements of the associative array. *datatype* can be any PL/SQL data type except REF CURSOR.

NOT NULL

Imposes the NOT NULL constraint on every element of the associative array. For information about this constraint, see "NOT NULL Constraint".

{ PLS_INTEGER | BINARY_INTEGER }

Specifies that the data type of the indexes of the associative array is `PLS_INTEGER`.

{ VARCHAR2 | VARCHAR | STRING } (v_size)

Specifies that the data type of the indexes of the associative array is `VARCHAR2` (or its subtype `VARCHAR` or `STRING`) with length `v_size`.

You can populate an element of the associative array with a value of any type that can be converted to `VARCHAR2` with the `TO_CHAR` function (described in *Oracle Database SQL Language Reference*).

 **Caution:**

Associative arrays indexed by strings can be affected by National Language Support (NLS) parameters. For more information, see "[NLS Parameter Values Affect Associative Arrays Indexed by String](#)".

LONG

Specifies that the data type of the indexes of the associative array is `LONG`, which is equivalent to `VARCHAR2 (32760)`.

 **Note:**

Oracle supports `LONG` only for backward compatibility with existing applications. For new applications, use `VARCHAR2 (32760)`.

type_attribute, rowtype_attribute

Specifies that the data type of the indexes of the associative array is a data type specified with either `%ROWTYPE` or `%TYPE`. This data type must represent either `PLS_INTEGER`, `BINARY_INTEGER`, or `VARCHAR2 (v_size)`.

varray_type_def

Type definition for a variable-size array.

size_limit

Maximum number of elements that the varray can have. `size_limit` must be an integer literal in the range from 1 through 2147483647.

datatype

Data type of the varray element. `datatype` can be any PL/SQL data type except `REF CURSOR`.

NOT NULL

Imposes the `NOT NULL` constraint on every element of the varray. For information about this constraint, see "[NOT NULL Constraint](#)".

nested_table_type_def

Type definition for a nested table.

datatype

Data type of the elements of the nested table. *datatype* can be any PL/SQL data type except REF CURSOR or NCLOB.

If *datatype* is a scalar type, then the nested table has a single column of that type, called COLUMN_VALUE.

If *datatype* is an ADT, then the columns of the nested table match the name and attributes of the ADT.

NOT NULL

Imposes the NOT NULL constraint on every element of the nested table. For information about this constraint, see "[NOT NULL Constraint](#)".

collection_variable_decl***new_collection_var***

Name of the collection variable that you are declaring.

assoc_array_type

Name of a previously defined associative array type; the data type of *new_collection_var*.

varray_type

Name of a previously defined VARRAY type; the data type of *new_collection_var*.

nested_table_type

Name of a previously defined nested table type; the data type of *new_collection_var*.

collection_constructor

Collection constructor for the data type of *new_collection_var*, which provides the initial value of *new_collection_var*.

collection_var_1

Name of a previously declared collection variable of the same data type as *new_collection_var*, which provides the initial value of *new_collection_var*.

 **Note:**

collection_var_1 and *new_collection_var* must have the same data type, not only elements of the same type.

collection_var_2

Name of a previously declared collection variable.

%TYPE

See "[%TYPE Attribute](#)".

Examples

- [Example 5-1](#), "Associative Array Indexed by String"
- [Example 5-2](#), "Function Returns Associative Array Indexed by PLS_INTEGER"
- [Example 5-4](#), "Varray (Variable-Size Array)"
- [Example 5-5](#), "Nested Table of Local Type"
- [Example 5-13](#), "Two-Dimensional Varray (Varray of Varrays)"
- [Example 5-14](#), "Nested Tables of Nested Tables and Varrays of Integers"

Related Topics

In this chapter:

- ["Collection Method Invocation"](#)
- ["FORALL Statement"](#)
- ["Record Variable Declaration"](#)
- ["%ROWTYPE Attribute"](#)
- ["%TYPE Attribute"](#)

In other chapters:

- ["Collection Topics"](#)
- ["BULK COLLECT Clause"](#)
- ["CREATE TYPE Statement"](#)

13.12 Comment

A comment is source program text that the PL/SQL compiler ignores. Its primary purpose is to document code, but you can also use it to disable obsolete or unfinished pieces of code (that is, you can turn the code into comments). PL/SQL has both single-line and multiline comments.

Topics

- [Syntax](#)
- [Semantics](#)
- [Examples](#)
- [Related Topics](#)

Syntax

comment ::=

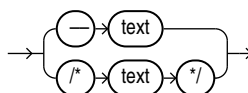

Semantics

comment

--

Turns the rest of the line into a single-line comment. Any text that wraps to the next line is not part of the comment.

Caution:

Do not put a single-line comment in a PL/SQL block to be processed dynamically by an Oracle Precompiler program. The Oracle Precompiler program ignores end-of-line characters, which means that a single-line comment ends when the block ends.

/*

Begins a comment, which can span multiple lines.

*/

Ends a comment.

text

Any text.

Restriction on *text*

In a multiline comment, *text* cannot include the multiline comment delimiter `/*` or `*/`. Therefore, one multiline comment cannot contain another multiline comment. However, a multiline comment can contain a single-line comment.

Examples

- [Example 2-6](#), "Single-Line Comments"
- [Example 2-7](#), "Multiline Comments"

Related Topics

- ["Comments"](#)

13.13 COMPILE Clause

The compile clause explicitly recompiles a stored unit that has become invalid, thus eliminating the need for implicit runtime recompilation and preventing associated runtime compilation errors and performance overhead.

The `COMPILE` clause can appear in the following SQL statements:

- [ALTER FUNCTION Statement](#)
- [ALTER PACKAGE Statement](#)
- [ALTER PROCEDURE Statement](#)

- ALTER LIBRARY Statement
- ALTER TYPE Statement
- ALTER TRIGGER Statement

Topics

- Syntax
- Semantics
- Related Topics

Syntax

compile_clause ::=

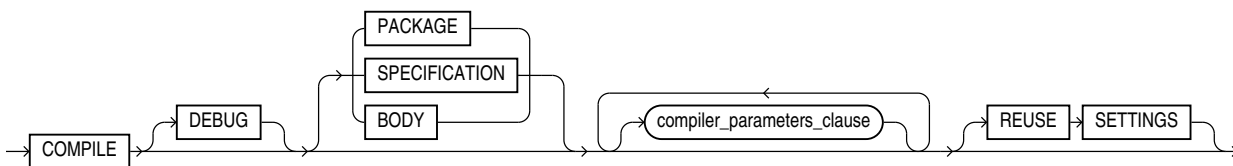

compiler_parameters_clause ::=

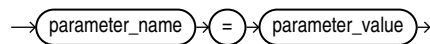

Semantics

compile_clause

COMPILE

Recompiles the PL/SQL unit, whether it is valid or invalid. The PL/SQL unit can be a library, package, package specification, package body, trigger, procedure, function, type, type specification, or type body.

First, if any of the objects upon which the unit depends are invalid, the database recompiles them.

The database also invalidates any local objects that depend upon the unit.

If the database recompiles the unit successfully, then the unit becomes valid. Otherwise, the database returns an error and the unit remains invalid. You can see the associated compiler error messages with the SQL*Plus command `SHOW ERRORS`.

During recompilation, the database drops all persistent compiler switch settings, retrieves them again from the session, and stores them after compilation. To avoid this process, specify the `REUSE SETTINGS` clause.

DEBUG

Has the same effect as `PLSQL_OPTIMIZE_LEVEL=1`—instructs the PL/SQL compiler to generate and store the code for use by the PL/SQL debugger. Oracle recommends using `PLSQL_OPTIMIZE_LEVEL=1` instead of `DEBUG`.

PACKAGE

(Default) Recompiles both the package specification and (if it exists) the package body, whether they are valid or invalid. The recompilation of the package specification and body lead to the invalidation and recompilation of dependent objects as described for `SPECIFICATION` and `BODY`.

Restriction on `PACKAGE`

`PACKAGE` may only appear if compiling a package.

SPECIFICATION

Recompiles only the package or type specification, whether it is valid or invalid. You might want to recompile a package or type specification to check for compilation errors after modifying the specification.

When you recompile a specification, the database invalidates any local objects that depend on the specification, such as procedures that invoke procedures or functions in the package. The body of a package also depends on its specification. If you subsequently reference one of these dependent objects without first explicitly recompiling it, then the database recompiles it implicitly at run time.

Restriction on `SPECIFICATION`

`SPECIFICATION` may only appear if compiling a package or type specification.

BODY

Recompiles only the package or type body, whether it is valid or invalid. You might want to recompile a package or type body after modifying it. Recompiling a body does not invalidate objects that depend upon its specification.

When you recompile a package or type body, the database first recompiles the objects on which the body depends, if any of those objects are invalid. If the database recompiles the body successfully, then the body becomes valid.

Restriction on `BODY`

`BODY` may only appear if compiling a package or type body.

REUSE SETTINGS

Prevents Oracle Database from dropping and reacquiring compiler switch settings. With this clause, Oracle preserves the existing settings and uses them for the recompilation of any parameters for which values are not specified elsewhere in this statement.

See also [DEFAULT COLLATION Clause](#) compilation semantics.

compiler_parameters_clause

Specifies a value for a PL/SQL compilation parameter in [Table 1-2](#). The compile-time value of each of these parameters is stored with the metadata of the PL/SQL unit being compiled.

You can specify each parameter only once in each statement. Each setting is valid only for the PL/SQL unit being compiled and does not affect other compilations in this session or system. To affect the entire session or system, you must set a value for the parameter using the `ALTER SESSION` or `ALTER SYSTEM` statement.

If you omit any parameter from this clause and you specify `REUSE SETTINGS`, then if a value was specified for the parameter in an earlier compilation of this PL/SQL unit, the database uses that earlier value. If you omit any parameter and either you do not specify `REUSE SETTINGS` or no value was specified for the parameter in an earlier compilation, then the database obtains the value for that parameter from the session environment.

Related Topics

In other books:

- *Oracle Database Development Guide* for information about debugging procedures
- *Oracle Database Development Guide* for information about debugging a trigger using the same facilities available for stored subprograms

13.14 Constant Declaration

A constant holds a value that does not change. A constant declaration specifies the name, data type, and value of the constant and allocates storage for it. The declaration can also impose the `NOT NULL` constraint.

Topics

- [Syntax](#)
- [Semantics](#)
- [Examples](#)
- [Related Topics](#)

Syntax

constant_declaration ::=

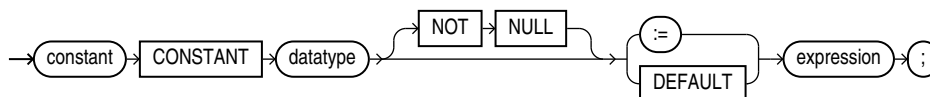

(datatype ::=, expression ::=)

Semantics

constant_declaration

constant

Name of the constant that you are declaring.

datatype

Data type for which a variable can be declared with an initial value.

NOT NULL

Imposes the `NOT NULL` constraint on the constant.

For information about this constraint, see "[NOT NULL Constraint](#)".

expression

Initial value for the constant. *expression* must have a data type that is compatible with *datatype*. When *constant_declaration* is elaborated, the value of *expression* is assigned to *constant*.

Examples

- [Example 2-12](#), "Constant Declarations"
- [Example 2-13](#), "Variable and Constant Declarations with Initial Values"

Related Topics

In this chapter:

- ["Collection Variable Declaration"](#)
- ["Record Variable Declaration"](#)
- ["%ROWTYPE Attribute"](#)
- ["Scalar Variable Declaration"](#)
- ["%TYPE Attribute"](#)

In other chapters:

- ["Declaring Constants"](#)
- ["Declaring Associative Array Constants"](#)
- ["Declaring Record Constants"](#)

13.15 CONTINUE Statement

The `CONTINUE` statement exits the current iteration of a loop, either conditionally or unconditionally, and transfers control to the next iteration of either the current loop or an enclosing labeled loop.

If a `CONTINUE` statement exits a cursor `FOR` loop prematurely (for example, to exit an inner loop and transfer control to the next iteration of an outer loop), the cursor closes (in this context, `CONTINUE` works like `GOTO`).



Note:

As of Oracle Database 11g Release 1, `CONTINUE` is a PL/SQL keyword. If your program invokes a subprogram named `CONTINUE`, you get a warning.

Restrictions on CONTINUE Statement

- A CONTINUE statement must be inside a LOOP statement.
- A CONTINUE statement cannot cross a subprogram or method boundary.

Topics

- [Syntax](#)
- [Semantics](#)
- [Examples](#)
- [Related Topics](#)

Syntax

continue_statement ::=

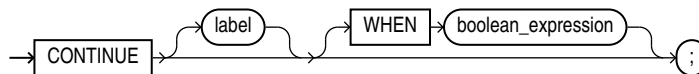

(boolean_expression ::=)

Semantics

continue_statement

label

Name that identifies either the current loop or an enclosing loop (see "[Basic LOOP Statement](#)").

Without *label*, the CONTINUE statement transfers control to the next iteration of the current loop. With *label*, the CONTINUE statement transfers control to the next iteration of the loop that *label* identifies.

WHEN boolean_expression

Without this clause, the CONTINUE statement exits the current iteration of the loop unconditionally. With this clause, the CONTINUE statement exits the current iteration of the loop if and only if the value of *boolean_expression* is TRUE.

Examples

- [Example 4-13](#), "CONTINUE Statement in Basic LOOP Statement"
- [Example 4-14](#), "CONTINUE WHEN Statement in Basic LOOP Statement"
- [Example 4-27](#), "CONTINUE WHEN Statement in Inner FOR LOOP Statement"

Related Topics

In this chapter:

- "[Basic LOOP Statement](#)"

- ["Cursor FOR LOOP Statement"](#)
- ["EXIT Statement"](#)
- ["Expression"](#)
- ["FOR LOOP Statement"](#)
- ["WHILE LOOP Statement"](#)

In other chapters:

- ["LOOP Statements"](#)
- ["CONTINUE Statement"](#)
- ["CONTINUE WHEN Statement"](#)

13.16 COVERAGE Pragma

The `COVERAGE` pragma marks PL/SQL code which is infeasible to test for coverage. These marks improve coverage metric accuracy.

The `COVERAGE` pragma marks PL/SQL source code to indicate that the code may not be feasibly tested for coverage. The pragma marks a specific code section. Marking infeasible code improves the quality of coverage metrics used to assess how much testing has been achieved.

Topics

- [Syntax](#)
- [Semantics](#)
- [Examples](#)
- [Related Topics](#)

Syntax

coverage_pragma ::=

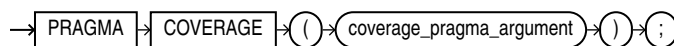

coverage_pragma_argument ::=

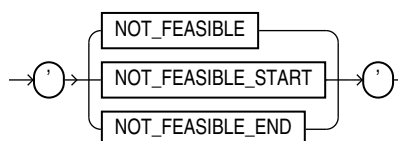

Semantics

coverage_pragma

The `COVERAGE` pragma may appear before any declaration or statement.

coverage_pragma_argument

The `COVERAGE` pragma argument must have one of these values:

- 'NOT_FEASIBLE'
- 'NOT_FEASIBLE_START'
- 'NOT_FEASIBLE_END'

When the `COVERAGE` pragma appear with the argument 'NOT_FEASIBLE', it marks the entire basic block that includes the beginning of the first declaration or statement that follows the pragma.

A `COVERAGE` pragma with an argument of 'NOT_FEASIBLE_START' may appear before any declaration or any statement. It must be followed by the `COVERAGE` pragma with an argument of 'NOT_FEASIBLE_END'. The second pragma may appear before any declaration or any statement. It must appear in the same PL/SQL block as the first pragma and not in any nested subprogram definition.

An associated pair of `COVERAGE` pragmas marks basic blocks infeasible from the beginning of the basic block that includes the beginning of the first statement or declaration that follows the first pragma to the end of the basic block that includes the first statement or declaration that follows the second pragma.

A `COVERAGE` pragma whose range includes the definition or declaration of an inner subprogram does not mark the blocks of that subprogram as infeasible.

Examples**Example 13-5 Marking a Single Basic Block as Infeasible to Test for Coverage**

This example shows the placement of the pragma `COVERAGE` preceding the assignments to `z` and `z1` basic blocks. These two basic blocks will be ignored for coverage calculation. The first `COVERAGE` pragma (marked 1) marks the first assignment to `z` infeasible; the second (marked 2) marks the third assignment to `z`. In each case, the affected basic block runs from the identifier `z` to the following `END IF`.

```
IF (x>0) THEN
  y :=2;
ELSE
  PRAGMA COVERAGE ('NOT_FEASIBLE'); -- 1
  z:=3;
END IF;
IF (y>0) THEN
  z :=2;
ELSE
  PRAGMA COVERAGE ('NOT_FEASIBLE'); -- 2
  z :=3;
END IF;
```

Example 13-6 Marking a Line Range as Infeasible to Test for Coverage

This examples shows marking the entire line range as not feasible. A line range may contain more than one basic block. A line range is marked as not feasible for coverage using a pragma `COVERAGE` with a 'NOT_FEASIBLE_START' argument at the beginning

of the range, and a pragma `COVERAGE` with a `'NOT_FEASIBLE_END'` at the end of the range. The range paired `COVERAGE` pragmas mark all the blocks as infeasible.

```
PRAGMA COVERAGE ('NOT_FEASIBLE_START');
IF (x>0) THEN
  y :=2;
ELSE
  z:=3;
END IF;
IF (y>0) THEN
  z :=2;
ELSE
  z :=3;
END IF;
PRAGMA COVERAGE ('NOT_FEASIBLE_END');
```

Example 13-7 Marking Entire Units or Individual Subprograms as Infeasible to Test for Coverage

This example shows marking the entire procedure `foo` as not feasible for coverage. A subprogram is marked as completely infeasible by marking all of its body infeasible.

```
CREATE PROCEDURE foo IS
PRAGMA COVERAGE ('NOT_FEASIBLE_START');
.....

BEGIN
....
PRAGMA COVERAGE ('NOT_FEASIBLE_END');
END;
/
```

Example 13-8 Marking Internal Subprogram as Infeasible to Test for Coverage

This example shows that the outer `COVERAGE` pragma pair has no effect on coverage inside procedure `inner`. The `COVERAGE` pragma (marked 1) inside the body of `inner` does mark the second assignment to `x` as infeasible. Notice that the entire body of procedure `outer` is marked infeasible even though the pragma with argument `'NOT_FEASIBLE_END'` is not the last line. The pragma does mark the basic block that includes the statement that follows the pragma and that block does extend to the end of the procedure.

```
CREATE OR REPLACE PROCEDURE outer IS
  PRAGMA COVERAGE ('NOT_FEASIBLE_START');
  x NUMBER := 7;
  PROCEDURE inner IS
  BEGIN
    IF x < 6 THEN
      x := 19;
    ELSE
      PRAGMA COVERAGE ('NOT_FEASIBLE'); -- 1
      x := 203;
    END IF;
  END;
BEGIN
```

```

DBMS_OUTPUT.PUT_LINE ('X= ');
PRAGMA COVERAGE ('NOT_FEASIBLE_END');
DBMS_OUTPUT.PUT_LINE (x);
END;
/

```

Related Topics

In this book:

- [Pragmas](#)
- [PL/SQL Units and Compilation Parameters](#) for more information about the PLSQL_OPTIMIZE_LEVEL compilation parameter

In other books:

- *Oracle Database Development Guide* for more information about using PL/SQL basic block coverage to maintain quality
- *Oracle Database PL/SQL Packages and Types Reference* for more information about using the DBMS_PLSQL_CODE_COVERAGE package

13.17 Cursor FOR LOOP Statement

The cursor `FOR LOOP` statement implicitly declares its loop index as a record variable of the row type that a specified cursor returns, and then opens a cursor.

With each iteration, the cursor `FOR LOOP` statement fetches a row from the result set into the record. When there are no more rows to fetch, the cursor `FOR LOOP` statement closes the cursor. The cursor also closes if a statement inside the loop transfers control outside the loop or raises an exception.

Topics

- [Syntax](#)
- [Semantics](#)
- [Examples](#)
- [Related Topics](#)

Syntax

cursor_for_loop_statement ::=

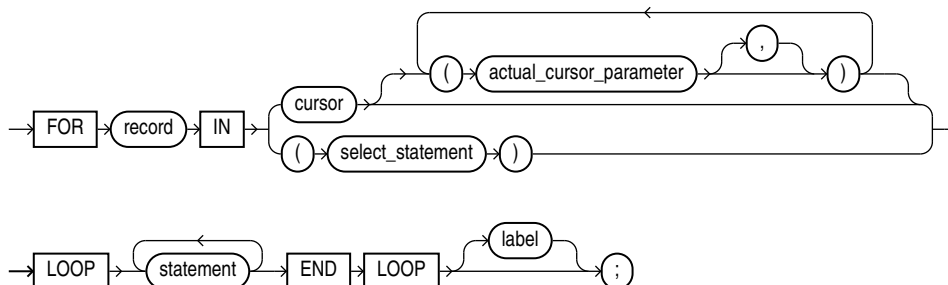

(*statement ::=*)

Semantics

cursor_for_loop_statement

record

Name for the loop index that the cursor FOR LOOP statement implicitly declares as a %ROWTYPE record variable of the type that *cursor* or *select_statement* returns.

record is local to the cursor FOR LOOP statement. Statements inside the loop can reference *record* and its fields. They can reference virtual columns only by aliases. Statements outside the loop cannot reference *record*. After the cursor FOR LOOP statement runs, *record* is undefined.

cursor

Name of an explicit cursor (not a cursor variable) that is not open when the cursor FOR LOOP is entered.

actual_cursor_parameter

Actual parameter that corresponds to a formal parameter of *cursor*.

select_statement

SQL SELECT statement (not PL/SQL SELECT INTO statement). For *select_statement*, PL/SQL declares, opens, fetches from, and closes an implicit cursor. However, because *select_statement* is not an independent statement, the implicit cursor is internal—you cannot reference it with the name SQL.



See Also:

Oracle Database SQL Language Reference for SELECT statement syntax

label

Label that identifies *cursor_for_loop_statement* (see "*statement ::=*" and "*label*"). CONTINUE, EXIT, and GOTO statements can reference this label.

Labels improve readability, especially when LOOP statements are nested, but only if you ensure that the label in the END LOOP statement matches a label at the beginning of the same LOOP statement (the compiler does not check).

Examples

- [Example 6-18](#), "Implicit Cursor FOR LOOP Statement"
- [Example 6-19](#), "Explicit Cursor FOR LOOP Statement"
- [Example 6-20](#), "Passing Parameters to Explicit Cursor FOR LOOP Statement"
- [Example 6-21](#), "Cursor FOR Loop References Virtual Columns"

Related Topics

In this chapter:

- ["Basic LOOP Statement"](#)
- ["CONTINUE Statement"](#)
- ["EXIT Statement"](#)
- ["Explicit Cursor Declaration and Definition"](#)
- ["FETCH Statement"](#)
- ["FOR LOOP Statement"](#)
- ["FORALL Statement"](#)
- ["OPEN Statement"](#)
- ["WHILE LOOP Statement"](#)

In other chapters:

- ["Processing Query Result Sets With Cursor FOR LOOP Statements"](#)

13.18 Cursor Variable Declaration

A cursor variable is like an explicit cursor that is not limited to one query.

To create a cursor variable, either declare a variable of the predefined type `SYS_REFCURSOR` or define a `REF CURSOR` type and then declare a variable of that type.

Restrictions on Cursor Variables

- You cannot use a cursor variable in a cursor `FOR LOOP` statement.
- You cannot declare a cursor variable in a package specification.
That is, a package cannot have a public cursor variable (a cursor variable that can be referenced from outside the package).
- You cannot store the value of a cursor variable in a collection or database column.
- You cannot use comparison operators to test cursor variables for equality, inequality, or nullity.
- Using a cursor variable in a server-to-server remote procedure call (RPC) causes an error. However, you can use a cursor variable in a server-to-server RPC if the remote database is a non-Oracle database accessed through a Procedural Gateway.

Topics

- [Syntax](#)
- [Semantics](#)
- [Examples](#)
- [Related Topics](#)

Syntax

ref_cursor_type_definition ::=

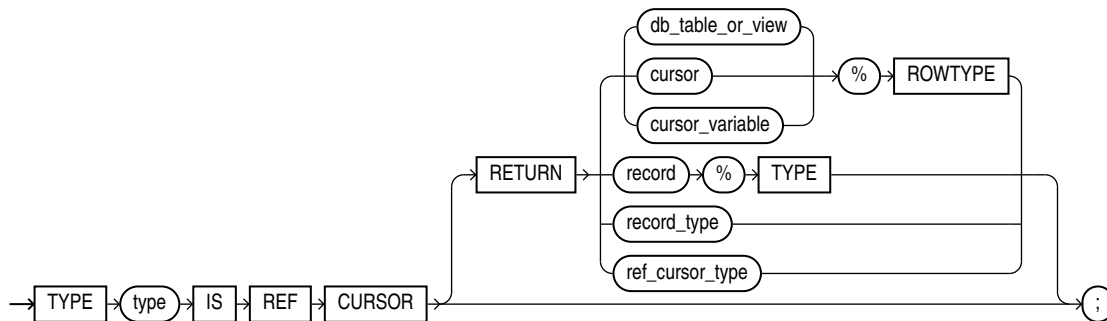

cursor_variable_declaration ::=

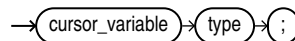

Semantics

ref_cursor_type_definition

type

Name of the `REF CURSOR` type that you are defining.

RETURN

Specifies the data type of the value that the cursor variable returns.

Specify `RETURN` to define a strong `REF CURSOR` type. Omit `RETURN` to define a weak `REF CURSOR` type. For information about strong and weak `REF CURSOR` types, see "[Creating Cursor Variables](#)".

db_table_or_view

Name of a database table or view, which must be accessible when the declaration is elaborated.

cursor

Name of a previously declared explicit cursor.

cursor_variable

Name of a previously declared cursor variable.

record

Name of a user-defined record.

record_type

Name of a user-defined type that was defined with the data type specifier `RECORD`.

ref_cursor_type

Name of a user-defined type that was defined with the data type specifier `REF CURSOR`.

cursor_variable_declaration

cursor_variable

Name of the cursor variable that you are declaring.

type

Type of the cursor variable that you are declaring—either `SYS_REFCURSOR` or the name of the `REF CURSOR` type that you defined previously.

`SYS_REFCURSOR` is a weak type. For information about strong and weak `REF CURSOR` types, see "[Creating Cursor Variables](#)".

Examples

- [Example 6-24](#), "Cursor Variable Declarations"
- [Example 6-25](#), "Cursor Variable with User-Defined Return Type"
- [Example 6-28](#), "Variable in Cursor Variable Query—No Result Set Change"
- [Example 6-29](#), "Variable in Cursor Variable Query—Result Set Change"
- [Example 6-30](#), "Querying a Collection with Static SQL"
- [Example 6-31](#), "Procedure to Open Cursor Variable for One Query"
- [Example 6-32](#), "Opening Cursor Variable for Chosen Query (Same Return Type)"
- [Example 6-33](#), "Opening Cursor Variable for Chosen Query (Different Return Types)"
- [Example 6-34](#), "Cursor Variable as Host Variable in Pro*C Client Program"

Related Topics

In this chapter:

- ["CLOSE Statement"](#)
- ["Named Cursor Attribute"](#)
- ["Explicit Cursor Declaration and Definition"](#)
- ["FETCH Statement"](#)
- ["OPEN FOR Statement"](#)
- ["%ROWTYPE Attribute"](#)
- ["%TYPE Attribute"](#)

In other chapters:

- ["Cursor Variables"](#)
- ["Passing CURSOR Expressions to Pipelined Table Functions"](#)

13.19 Datatype Attribute

The data type attribute of an ADT element.

A `datatype` allows you to declare the data type of record variables fields, constants, functions return value, collection variables and collection types elements.

- [Record Variable Declaration](#)
- [Constant Declaration](#)
- [Function Declaration and Definition](#)
- [Collection Variable Declaration](#)
- [CREATE FUNCTION Statement](#)
- [CREATE TYPE Statement](#)

Topics

- [Syntax](#)
- [Semantics](#)
- [Related Topics](#)

Syntax

datatype ::=

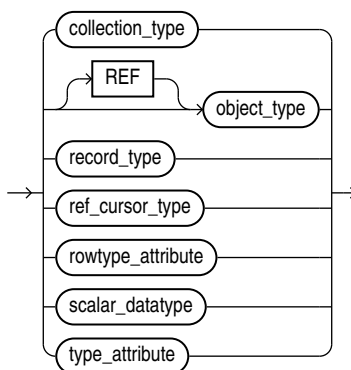

(*rowtype_attribute ::=*, *type_attribute ::=*)

Semantics

datatype

collection_type

Name of a user-defined varray or nested table type (not the name of an associative array type).

object_type

Instance of a user-defined type.

record_type

Name of a user-defined type that was defined with the data type specifier `RECORD`.

ref_cursor_type

Name of a user-defined type that was defined with the data type specifier `REF CURSOR`.

scalar_datatype

Name of a scalar data type, including any qualifiers for size, precision, and character or byte semantics.

Related Topics

In other chapters:

- [PL/SQL Data Types](#)

13.20 DEFAULT COLLATION Clause

Collation (also called sort ordering) determines if a character string equals, precedes, or follows another string when the two strings are compared and sorted. Oracle Database collations order strings following rules for sorted text used in different languages.

The `DEFAULT COLLATION` clause can appear in the following SQL statements:

- [CREATE FUNCTION Statement](#)
- [CREATE PROCEDURE Statement](#)
- [CREATE PACKAGE Statement](#)
- [CREATE TRIGGER Statement](#)
- [CREATE TYPE Statement](#)

Topics

- [Prerequisites](#)
- [Syntax](#)
- [Semantics](#)
- [Compilation Semantics](#)
- [Related Topics](#)

Prerequisites

The `COMPATIBLE` initialization parameter must be set to at least 12.2.0, and `MAX_STRING_SIZE` must be set to `EXTENDED` for collation declarations to be allowed in these SQL statements.

Syntax

***default_collation_clause* ::=**

→ `DEFAULT` → `COLLATION` → `collation_option` →

collation_option ::=

→ USING_NLS_COMP →

Semantics

default_collation_clause

The *default_collation_clause* can appear in a package specification, a standalone type specification, and in standalone subprograms.

collation_option

The default collation of a procedure, function, package, type, or trigger must be USING_NLS_COMP. The *default_collation_clause* explicitly declares the default collation of a PL/SQL unit to be USING_NLS_COMP. Without this clause, the unit inherits its default collation from the effective schema default collation. If the effective schema default collation is not USING_NLS_COMP, the unit is invalid.

The effective schema default collation is determined as follows:

- If the session parameter DEFAULT_COLLATION is set, the effective schema default collation is the value of this parameter. The value of the parameter can be checked by querying SYS_CONTEXT('USERENV', 'SESSION_DEFAULT_COLLATION'). The function returns NULL if DEFAULT_COLLATION is not set. The value of the parameter DEFAULT_COLLATION can be set with the statement: ALTER SESSION SET DEFAULT_COLLATION = *collation_option*;
- If the session parameter DEFAULT_COLLATION is not set, the effective schema default collation is the declared default collation of the schema in which you create the PL/SQL unit. The default collation of a schema can be found in the static data dictionary *_USERS views. It can be set with the DDL statements CREATE USER and ALTER USER.

The session parameter DEFAULT_COLLATION can be unset with the statement: ALTER SESSION SET DEFAULT_COLLATION = NONE;

Package body and type body use the default collation of the corresponding specification. All character data containers and attributes in procedures, functions and methods, including parameters and return values, behave as if their data-bound collation were the pseudo-collation USING_NLS_COMP.

Restrictions on DEFAULT COLLATION

It cannot be specified for nested or packaged subprograms or for type methods.

Compilation Semantics

If the resulting default object collation is different from USING_NLS_COMP, the database object is created as invalid with a compilation error.

If the ALTER COMPILE statement is issued for a PL/SQL unit with the REUSE SETTINGS clause, the stored default collation of the database object being compiled is not changed.

If an ALTER COMPILE statement is issued without the REUSE SETTINGS clause, the stored default collation of the database object being compiled is discarded and the effective schema default collation for the object owner at the time of execution of the statement is stored as the

default collation of the object, unless the PL/SQL unit contains the `DEFAULT COLLATION` clause. If the resulting default collation is not `USING_NLS_COMP`, a compilation error is raised.

An `ALTER COMPILE` statement for a package or type body references the stored collation of the corresponding specification.

Related Topics

In other chapters:

- [ALTER FUNCTION Statement](#)
- [ALTER PACKAGE Statement](#)
- [ALTER PROCEDURE Statement](#)
- [ALTER TRIGGER Statement](#)
- [ALTER TYPE Statement](#)

In other books :

- *Oracle Database Globalization Support Guide* for more information about specifying data-bound collation for PL/SQL units
- *Oracle Database Globalization Support Guide* for more information about effective schema default collation

13.21 DELETE Statement Extension

The PL/SQL extension to the *where_clause* of the SQL `DELETE` statement lets you specify a `CURRENT OF` clause, which restricts the `DELETE` statement to the current row of the specified cursor.

For information about the `CURRENT OF` clause, see "[UPDATE Statement Extensions](#)".



See Also:

Oracle Database SQL Language Reference for the syntax of the SQL `DELETE` statement

13.22 DEPRECATE Pragma

The `DEPRECATE` pragma marks a PL/SQL element as deprecated. The compiler issues warnings for uses of pragma `DEPRECATE` or of deprecated elements.

The associated warnings tell users of a deprecated element that other code may need to be changed to account for the deprecation.

Topics

- [Syntax](#)
- [Semantics](#)
- [DEPRECATE Pragma Compilation Warnings](#)

- [Examples](#)
- [Related Topics](#)

Syntax

deprecate_pragma ::=

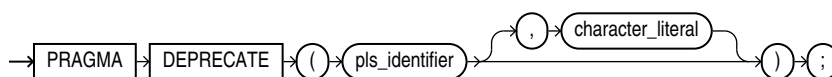

Semantics

deprecate_pragma

The `DEPRECATE` pragma may only appear in the declaration sections of a package specification, an object specification, a top level procedure, or a top level function.

PL/SQL elements of these kinds may be deprecated:

- Subprograms
- Packages
- Variables
- Constants
- Types
- Subtypes
- Exceptions
- Cursors

The `DEPRECATE` pragma may only appear in the declaration section of a PL/SQL unit. It must appear immediately after the declaration of an item to be deprecated.

The `DEPRECATE` pragma applies to the PL/SQL element named in the declaration which precedes the pragma.

When the `DEPRECATE` pragma applies to a package specification, object specification, or subprogram, the pragma must appear immediately after the keyword `IS` or `AS` that terminates the declaration portion of the definition.

When the `DEPRECATE` pragma applies to a package or object specification, references to all the elements (of the kinds that can be deprecated) that are declared in the specification are also deprecated.

If the `DEPRECATE` pragma applies to a subprogram declaration, only that subprogram is affected; other overloads with the same name are not deprecated.

If the optional custom message appears in a use of the `DEPRECATE` pragma, the custom message will be added to the warning issued for any reference to the deprecated element.

The identifier in a `DEPRECATE` pragma must name the element in the declaration to which it applies.

Deprecation is inherited during type derivation. A child object type whose parent is deprecated is not deprecated. Only the attributes and methods that are inherited are deprecated.

When the base type is not deprecated but individual methods or attributes are deprecated, and when a type is derived from this type and the deprecated type or method is inherited, then references to these through the derived type will cause the compiler to issue a warning.

A reference to a deprecated element appearing anywhere except in the unit with the deprecation pragma or its body, will cause the PL/SQL compiler to issue a warning for the referenced elements. A reference to a deprecated element in an anonymous block will not cause the compiler to issue a warning; only references in named entities will draw a warning.

When a deprecated entity is referenced in the definition of another deprecated entity then no warning will be issued.

When an older client code refers to a deprecated entity, it is invalidated and recompiled. No warning is issued.

There is no effect when SQL code directly references a deprecated element.

A reference to a deprecated element in a PL/SQL static SQL statement may cause the PL/SQL compiler to issue a warning. However, such references may not be detectable.

pls_identifier

Identifier of the PL/SQL element being deprecated.

character_literal

An optional compile-time warning message.

DEPRECATE Pragma Compilation Warnings

The PL/SQL compiler issues warnings when the `DEPRECATE` pragma is used and when deprecated items are referenced.

- 6019 — The entity was deprecated and could be removed in a future release. Do not use the deprecated entity.
- 6020 — The referenced entity was deprecated and could be removed in a future release. Do not use the deprecated entity. Follow the specific instructions in the warning if any are given.
- 6021 — Misplaced pragma. The pragma `DEPRECATE` should follow immediately after the declaration of the entity that is being deprecated. Place the pragma immediately after the declaration of the entity that is being deprecated.
- 6022 — This entity cannot be deprecated. Deprecation only applies to entities that may be declared in a package or type specification as well as to top-level procedure and function definitions. Remove the pragma.

The `DEPRECATE` pragma warnings may be managed with the `PLSQL_WARNINGS` parameter or with the `DBMS_WARNING` package.

Examples

Example 13-9 Enabling the Deprecation Warnings

This example shows how to set the PLSQL_WARNINGS parameter to enable these warnings in a session.

Live SQL:

You can view and run this example on Oracle Live SQL at [Restricting Access to Top-Level Procedures in the Same Schema](#)

```
ALTER SESSION SET PLSQL_WARNINGS='ENABLE:(6019,6020,6021,6022)';
```

Example 13-10 Deprecation of a PL/SQL Package

This example shows the deprecation of a PL/SQL package as a whole. Warnings will be issued for any reference to package pack1, and to the procedures foo and bar when used outside of the package and its body.

Live SQL:

You can view and run this example on Oracle Live SQL at [Deprecation of a PL/SQL Package](#)

```
PACKAGE pack1 AS
PRAGMA DEPRECATE(pack1);
  PROCEDURE foo;
  PROCEDURE bar;
END pack1;
```

Example 13-11 Deprecation of a PL/SQL Package with a Custom Warning

This example shows the deprecation of a PL/SQL package. The compiler issues a custom warning message when a reference in another unit for the deprecated procedure foo is compiled.

Live SQL:

You can view and run this example on Oracle Live SQL at [Deprecation of a PL/SQL Package with a Custom Warning](#)

```
PACKAGE pack5 AUTHID DEFINER AS
PRAGMA DEPRECATE(pack5 , 'Package pack5 has been deprecated, use new_pack5
instead.');
```

```
PROCEDURE foo;
PROCEDURE bar;
END pack5;
```

A reference to procedure `pack5.foo` in another unit would draw a warning like this.

```
SP2-0810: Package Body created with compilation warnings
```

```
Errors for PACKAGE BODY PACK6:
```

```
4/10      PLW-06020: reference to a deprecated entity: PACK5 declared in unit
PACK5[1,9].
```

```
Package pack5 has been deprecated, use new_pack5 instead
```

Example 13-12 Deprecation of a PL/SQL Procedure

This example shows the deprecation of a single PL/SQL procedure `foo` in package `pack7`.

Live SQL:

You can view and run this example on Oracle Live SQL at [Deprecation of a PL/SQL Procedure](#)

```
PACKAGE pack7 AUTHID DEFINER AS
  PROCEDURE foo;
  PRAGMA DEPRECATE (foo, 'pack7.foo is deprecated, use pack7.bar
instead.');
```

```
  PROCEDURE bar;
END pack7;
```

Example 13-13 Deprecation of an Overloaded Procedure

This example shows the `DEPRECATE` pragma applies only to a specific overload of a procedure name. Only the second declaration of `proc1` is deprecated.

Live SQL:

You can view and run this example on Oracle Live SQL at [Deprecation of an Overloaded Procedure](#)

```
PACKAGE pack2 AS
  PROCEDURE proc1(n1 NUMBER, n2 NUMBER, n3 NUMBER);
  -- Only the overloaded procedure with 2 arguments is deprecated
  PROCEDURE proc1(n1 NUMBER, n2 NUMBER);
  PRAGMA DEPRECATE(proc1);
END pack2;
```

Example 13-14 Deprecation of a Constant and of an Exception **Live SQL:**

You can view and run this example on Oracle Live SQL at [Deprecation of a Constant and of an Exception](#)

This example shows the deprecation of a constant and of an exception.

```
PACKAGE trans_data AUTHID DEFINER AS
  TYPE Transrec IS RECORD (
    accounttype VARCHAR2(30) ,
    ownername VARCHAR2(30) ,
    balance REAL
  );
  min_balance constant real := 10.0;
  PRAGMA DEPRECATE(min_balance , 'Minimum balance requirement has been
removed.');
```

```
  insufficient_funds EXCEPTION;
  PRAGMA DEPRECATE (insufficient_funds , 'Exception no longer raised.');
```

```
END trans_data;
```

Example 13-15 Using Conditional Compilation to Deprecate Entities in Some Database Releases

This example shows the deprecation of procedure proc1 if the database release version is greater than 11.

 **Live SQL:**

You can view and run this example on Oracle Live SQL at [Using Conditional Compilation to Deprecate Entities in Some Database Releases](#)

```
CREATE PACKAGE pack11 AUTHID DEFINER AS
  $IF DBMS_DB_VERSION.VER_LE_11
  $THEN
    PROCEDURE proc1;
  $ELSE
    PROCEDURE proc1;
    PRAGMA DEPRECATE(proc1);
  $END
  PROCEDURE proc2;
  PROCEDURE proc3;
END pack11;
```

Example 13-16 Deprecation of an Object Type

This example shows the deprecation of an entire object type.

 **Live SQL:**

You can view and run this example on Oracle Live SQL at [Deprecation of an Object Type](#)

```
TYPE type01 AS OBJECT(
  PRAGMA DEPRECATE (type01),
  y NUMBER,
  MEMBER PROCEDURE proc(x NUMBER),
  MEMBER PROCEDURE proc2(x NUMBER)
);
```

Example 13-17 Deprecation of a Member Function in an Object Type Specification

This example shows the deprecation of member function add2 in an object type specification.

 **Live SQL:**

You can view and run this example on Oracle Live SQL at [Deprecation of a Member Function in an Object Type Specification](#)

```
TYPE objdata AS OBJECT(
  n1 NUMBER ,
  n2 NUMBER ,
  n3 NUMBER ,
  MEMBER FUNCTION add2 RETURN NUMBER ,
  PRAGMA DEPRECATE (add2),
  MEMBER FUNCTION add_all RETURN NUMBER
);
```

Example 13-18 Deprecation of Inherited Object Types

This example shows that a reference to a deprecated entity x declared in unit type15_basetype type body will cause the compiler to issue a warning.

 **Live SQL:**

You can view and run this example on Oracle Live SQL at [Deprecation of Inherited Object Types](#)

```
TYPE type15_basetype AS OBJECT
(
  x1 NUMBER,
```

```
x NUMBER,
PRAGMA DEPRECATE (x),
MEMBER PROCEDURE f0 ,
PRAGMA DEPRECATE (f0),
MEMBER PROCEDURE f1 ,
PRAGMA DEPRECATE (f1),
MEMBER PROCEDURE f2 ,
PRAGMA DEPRECATE (f2),
MEMBER PROCEDURE f3) NOT FINAL;

TYPE BODY type15_basetype AS
  MEMBER PROCEDURE f0
  IS
  BEGIN
    x := 1;
  END;
  MEMBER PROCEDURE f1
  IS
  BEGIN
    x := 1;
  END;

  MEMBER PROCEDURE f2
  IS
  BEGIN
    x := 1;
  END;

  MEMBER PROCEDURE f3
  IS
  BEGIN
    x := 1;
  END;
END;
```

References to the deprecated entities x, f0, and f2 in type15_basetype type body will cause the compiler to issue a warning.

```
TYPE type15_subtype UNDER type15_basetype (
  y NUMBER ,
  MEMBER PROCEDURE f1(z NUMBER),
  MEMBER PROCEDURE f1(z NUMBER , m1 NUMBER),
  PRAGMA DEPRECATE (f1),
  OVERRIDING MEMBER PROCEDURE f2
);

TYPE BODY type15_subtype AS
  MEMBER PROCEDURE f1(z NUMBER)
  IS
  BEGIN
    -- deprecation attribute inherited in derived type.
    x := 1;
```

```

x1:= 2;
SELF.f0;
END;

MEMBER PROCEDURE f1(z NUMBER ,
                   m1 NUMBER)
IS
BEGIN
  NULL;
END;
OVERRIDING MEMBER PROCEDURE f2
IS
BEGIN
  /* refer to deprecated f2 in supertype */
  (SELF AS type15_basetype).f2;
  /* No warning for a reference to a not deprecated data member in
the supertype */
  x1 := 1;
END;
END;

```

References to deprecated entities x, f1, and f0 in unit type15_basetype will cause the compiler to issue a warning.

```

PROCEDURE test_types3
AS
  e type15_subtype ;
  d type15_basetype ;
BEGIN
  e := type15_subtype (1 ,1 ,1);
  d := type15_basetype (1, 1);
  d.x := 2; -- warning issued
  d.f1;    -- warning issued
  e.f1 (4); -- overloaded in derived type. no warning. not deprecated
in the derived type.
  e.f1 (1); -- no warning
  e.f0;    -- f0 is deprecated in base type. deprecation is
inherited. warning issued
          -- warning issued for deprecated x in d.x and e.x

  DBMS_OUTPUT.PUT_LINE(to_char(e.x) || to_char(' ') || to_char(d.x));
END;

```

Example 13-19 Deprecation Only Applies to Top Level Subprogram

This examples shows that the `DEPRECATE` pragma may not be used to deprecate a nested procedure. The compiler issues a warning about the misuse of the pragma on the entity. The pragma has no effect.

 **Live SQL:**

You can view and run this example on Oracle Live SQL at [Deprecation Only Applies to Top Level Subprogram](#)

```
PROCEDURE foo
IS
  PROCEDURE inner_foo
  IS
    PRAGMA DEPRECATE (inner_foo, 'procedure inner_foo is deprecated');
  BEGIN
    DBMS_OUTPUT.PUT_LINE('Executing inner_foo');
  END;
BEGIN
  DBMS_OUTPUT.PUT_LINE('Executing foo');
END;
```

Example 13-20 Misplaced DEPRECATE Pragma

The `DEPRECATE` pragma must appear immediately after the declaration of the deprecated item. A warning about the misplaced pragma will be issued and the pragma will have no effect.

 **Live SQL:**

You can view and run this example on Oracle Live SQL at [Misplaced DEPRECATE Pragma](#)

```
PROCEDURE bar
IS
BEGIN
  PRAGMA DEPRECATE(bar);
  DBMS_OUTPUT.PUT_LINE('Executing bar.');
```

```
END;
```

Example 13-21 Mismatch of the Element Name and the DEPRECATE Pragma Argument

This example shows that if the argument for the pragma does not match the name in the declaration, the pragma is ignored and the compiler does not issue a warning.

 **Live SQL:**

You can view and run this example on Oracle Live SQL at [Mismatch of the Element Name and the DEPRECATE Pragma Argument](#)

```
PACKAGE pkg13
AS
  PRAGMA DEPRECATE ('pkg13', 'Package pkg13 is deprecated, use pkg03');
  Y NUMBER;
END pkg13;
```

If an identifier is applied with a mismatched name, then the compiler issues a warning about the pragma being misplaced. The pragma has no effect.

```
CREATE PACKAGE pkg17
IS
  PRAGMA DEPRECATE ("pkg17");
END pkg17;
```

Related Topics

In this book:

- [Pragmas](#)
- [PL/SQL Units and Compilation Parameters](#) for more information about setting the `PLSQL_WARNINGS` compilation parameter

In other books:

- *Oracle Development Guide* for more information about deprecating packages, subprograms, and types
- *Oracle Database PL/SQL Packages and Types Reference* for more information about enabling the deprecation warnings using the `DBMS_WARNING.ADD_WARNING_SETTING_NUM` procedure
- [Compile-Time Warnings](#) for more information compilation warnings.

13.23 DETERMINISTIC Clause

The deterministic option marks a function that returns predictable results and has no side effects.

Function-based indexes, virtual column definitions that use PL/SQL functions, and materialized views that have query-rewrite enabled require special function properties. The `DETERMINISTIC` clause asserts that a function has those properties.

The `DETERMINISTIC` option can appear in the following statements:

- [Function Declaration and Definition](#)
- [CREATE FUNCTION Statement](#)
- [CREATE PACKAGE Statement](#)

- [CREATE TYPE BODY Statement](#)

Topics

- [Syntax](#)
- [Semantics](#)
- [Usage Notes](#)
- [Related Topics](#)

Syntax

deterministic_clause ::=

→ DETERMINISTIC →

Semantics

deterministic_clause

DETERMINISTIC

A function is deterministic if the `DETERMINISTIC` clause appears in either a declaration or the definition of the function.

The `DETERMINISTIC` clause may appear at most once in a function declaration and at most once in a function definition.

A deterministic function must return the same value on two distinct invocations if the arguments provided to the two invocations are the same.

A `DETERMINISTIC` function may not have side effects.

A `DETERMINISTIC` function may not raise an unhandled exception.

If a function with a `DETERMINISTIC` clause violates any of these semantic rules, the results of its invocation, its value, and the effect on its invoker are all undefined.

Usage Notes

The `DETERMINISTIC` clause is an assertion that the function obeys the semantic rules. If the function does not, neither the compiler, SQL execution, or PL/SQL execution may diagnose the problem and wrong results may be silently produced.

You must specify this keyword if you intend to invoke the function in the expression of a function-based index, in a virtual column definition, or from the query of a materialized view that is marked `REFRESH FAST` or `ENABLE QUERY REWRITE`. When the database encounters a deterministic function, it tries to use previously calculated results when possible rather than reexecuting the function. If you change the function, then you must manually rebuild all dependent function-based indexes and materialized views.

Do not specify `DETERMINISTIC` for a function whose result depends on the state of session variables or schema objects, because results might vary across invocations.

Do not specify this clause to define a function that uses package variables or that accesses the database in any way that might affect the return result of the function.

Specifying this clause for polymorphic table function is not allowed.

When the `DETERMINISTIC` option appears, the compiler may use the mark to improve the performance of the execution of the function.

It is good programming practice to make functions that fall into these categories `DETERMINISTIC`:

- Functions used in a `WHERE`, `ORDER BY`, or `GROUP BY` clause
- Functions that `MAP` or `ORDER` methods of a SQL type
- Functions that help determine whether or where a row appears in a result set

Related Topics

In other chapters:

- ["Subprogram Side Effects"](#)

In other books:

- `CREATE INDEX` statement in *Oracle Database SQL Language Reference*
- Oracle Database Data Warehousing Guide for information about materialized views
- *Oracle Database SQL Language Reference* for information about function-based indexes

13.24 Element Specification

An element specification specifies each attribute of the ADT.

An element specification can appear in the following SQL statements :

- [ALTER TYPE Statement](#)
- [CREATE TYPE Statement](#)

Topics

- [Syntax](#)
- [Semantics](#)

Syntax

`element_spec ::=`

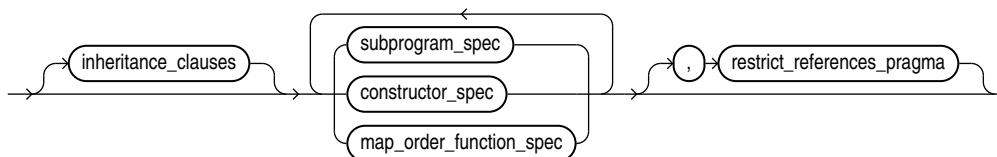

([subprogram_spec ::=](#) , [constructor_spec ::=](#) , [map_order_function_spec ::=](#) , [restrict_references_pragma ::=](#))

inheritance_clauses ::=

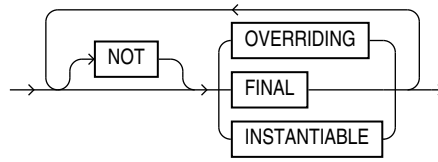

subprogram_spec ::=

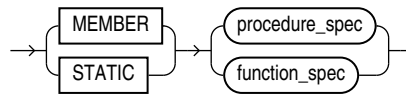

(*procedure_spec ::=, function_spec ::=*)

procedure_spec ::=

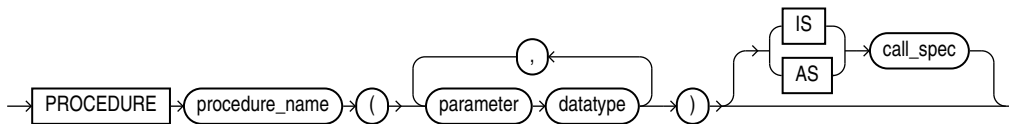

(*call_spec ::=*)

function_spec ::=

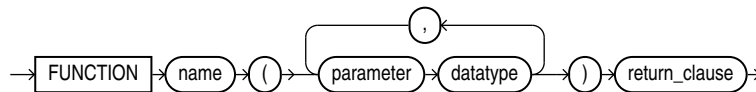

return_clause ::=

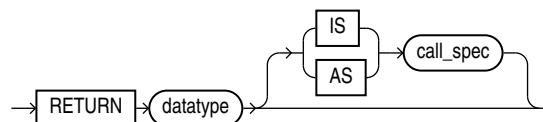

(*call_spec ::=*)

constructor_spec ::=

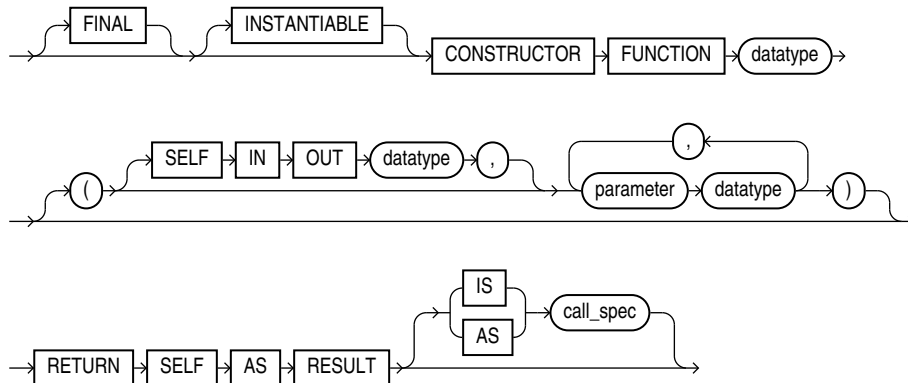

(call_spec ::=)

map_order_function_spec ::=

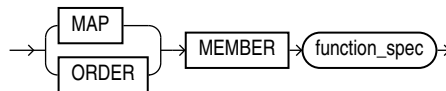

(function_spec ::=)

Semantics

element_spec

inheritance_clauses

Specifies the relationship between supertypes and subtypes.

[NOT] OVERRIDING

Specifies that this method overrides a `MEMBER` method defined in the supertype. This keyword is required if the method redefines a supertype method. **Default:** NOT OVERRIDING.

[NOT] FINAL

Specifies that this method cannot be overridden by any subtype of this type. **Default:** NOT FINAL.

[NOT] INSTANTIABLE

Specifies that the type does not provide an implementation for this method. **Default:** all methods are INSTANTIABLE.

Restriction on NOT INSTANTIABLE

If you specify NOT INSTANTIABLE, then you cannot specify FINAL or STATIC.

 **See Also:**
[constructor_spec](#)

subprogram_spec

Specifies a subprogram to be referenced as an ADT attribute. For each such subprogram, you must specify a corresponding method body in the ADT body.

Restriction on *subprogram_spec*

You cannot define a `STATIC` method on a subtype that redefines a `MEMBER` method in its supertype, or vice versa.

MEMBER

A subprogram associated with the ADT that is referenced as an attribute. Typically, you invoke `MEMBER` methods in a selfish style, such as `object_expression.method()`. This class of method has an implicit first argument referenced as `SELF` in the method body, which represents the object on which the method was invoked.

 **See Also:**
["Example 14-30"](#)

STATIC

A subprogram associated with the ADT. Unlike `MEMBER` methods, `STATIC` methods do not have any implicit parameters. You cannot reference `SELF` in their body. They are typically invoked as `type_name.method()`.

Restrictions on `STATIC`

- You cannot map a `MEMBER` method in a Java class to a `STATIC` method in a SQLJ object type.
- For both `MEMBER` and `STATIC` methods, you must specify a corresponding method body in the type body for each procedure or function specification.

 **See Also:**
["Example 14-31"](#)

procedure_spec* or *function_spec

Specifies the parameters and data types of the procedure or function. If this subprogram does not include the declaration of the procedure or function, then you must issue a corresponding `CREATE TYPE BODY` statement.

Restriction on *procedure_spec* or *function_spec*

If you are creating a subtype, then the name of the procedure or function cannot be the same as the name of any attribute, whether inherited or not, declared in the supertype chain.

return_clause

The first form of the *return_clause* is valid only for a function. The syntax shown is an abbreviated form.



See Also:

"[Collection Method Invocation](#)" for information about method invocation and methods

constructor_spec

Creates a user-defined constructor, which is a function that returns an initialized instance of an ADT. You can declare multiple constructors for a single ADT, if the parameters of each constructor differ in number, order, or data type.

- User-defined constructor functions are always `FINAL` and `INSTANTIABLE`, so these keywords are optional.
- The parameter-passing mode of user-defined constructors is always `SELF IN OUT`. Therefore you need not specify this clause unless you want to do so for clarity.
- `RETURN SELF AS RESULT` specifies that the runtime type of the value returned by the constructor is runtime type of the `SELF` argument.



See Also:

Oracle Database Object-Relational Developer's Guide for more information about and examples of user-defined constructors and "[Example 14-29](#)"

map_order_function_spec

You can declare either one `MAP` method or one `ORDER` method in a type specification, regardless of how many `MEMBER` or `STATIC` methods you declare. If you declare either method, then you can compare object instances in SQL.

If you do not declare either method, then you can compare object instances only for equality or inequality. Instances of the same type definition are equal only if each pair of their corresponding attributes is equal. You must not specify a comparison method to determine the equality of two ADTs.

You cannot declare either `MAP` or `ORDER` methods for subtypes. However, a subtype can override a `MAP` method if the supertype defines a `NOT FINAL MAP` method. A subtype cannot override an `ORDER` method at all.

You can specify either `MAP` or `ORDER` when mapping a Java class to a SQL type. However, the `MAP` or `ORDER` methods must map to `MEMBER` functions in the Java class.

If neither a `MAP` nor an `ORDER` method is specified, then only comparisons for equality or inequality can be performed. Therefore object instances cannot be ordered. Instances of the same type definition are equal only if each pair of their corresponding attributes is equal. No comparison method must be specified to determine the equality of two ADTs.

Use `MAP` if you are performing extensive sorting or hash join operations on object instances. `MAP` is applied once to map the objects to scalar values, and then the database uses the scalars during sorting and merging. A `MAP` method is more efficient than an `ORDER` method, which must invoke the method for each object comparison. You must use a `MAP` method for hash joins. You cannot use an `ORDER` method because the hash mechanism hashes on the object value.

 **See Also:**

Oracle Database Object-Relational Developer's Guide for more information about object value comparisons

MAP MEMBER

Specifies a `MAP` member function (`MAP` method) that returns the relative position of a given instance in the ordering of all instances of the object. A `MAP` method is called implicitly and induces an ordering of object instances by mapping them to values of a predefined scalar type. PL/SQL uses the ordering to evaluate Boolean expressions and to perform comparisons.

If the argument to the `MAP` method is `NULL`, then the `MAP` method returns `NULL` and the method is not invoked.

An object specification can contain only one `MAP` method, which must be a function. The result type must be a predefined SQL scalar type, and the `MAP` method can have no arguments other than the implicit `SELF` argument.

 **Note:**

If `type_name` is to be referenced in queries containing sorts (through an `ORDER BY`, `GROUP BY`, `DISTINCT`, or `UNION` clause) or containing joins, and you want those queries to be parallelized, then you must specify a `MAP` member function.

A subtype cannot define a new `MAP` method, but it can override an inherited `MAP` method.

ORDER MEMBER

Specifies an `ORDER` member function (`ORDER` method) that takes an instance of an object as an explicit argument and the implicit `SELF` argument and returns either a negative, zero, or positive integer. The negative, positive, or zero indicates that the implicit `SELF` argument is less than, equal to, or greater than the explicit argument.

If either argument to the `ORDER` method is `NULL`, then the `ORDER` method returns `NULL` and the method is not invoked.

When instances of the same ADT definition are compared in an `ORDER BY` clause, the `ORDER` method function is invoked.

An object specification can contain only one `ORDER` method, which must be a function having the return type `NUMBER`.

A subtype can neither define nor override an `ORDER` method.

Restriction on *map_order_function_spec*

You cannot add an `ORDER` method to a subtype.

restrict_references_pragma

Deprecated clause, described in "[RESTRICT_REFERENCES Pragma](#)".

Restriction on *restrict_references_pragma*

This clause is not valid when dropping a method.

13.25 EXCEPTION_INIT Pragma

The `EXCEPTION_INIT` pragma associates a user-defined exception name with an error code.

The `EXCEPTION_INIT` pragma can appear only in the same declarative part as its associated exception, anywhere after the exception declaration.

Topics

- [Syntax](#)
- [Semantics](#)
- [Examples](#)
- [Related Topics](#)

Syntax

exception_init_pragma ::=

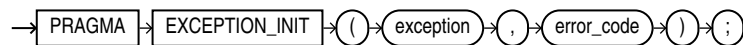

Semantics

exception_init_pragma

exception

Name of a previously declared user-defined exception.

error_code

Error code to be associated with *exception*. *error_code* can be either 100 (the numeric code for "no data found" that "[SQLCODE Function](#)" returns) or any negative integer greater than -10000000 except -1403 (another numeric code for "no data found").

**Note:**

`NO_DATA_FOUND` is a predefined exception.

If two `EXCEPTION_INIT` pragmas assign different error codes to the same user-defined exception, then the later pragma overrides the earlier pragma.

Examples

- [Example 11-5](#), "Naming Internally Defined Exception"
- [Example 11-13](#), "Raising User-Defined Exception with `RAISE_APPLICATION_ERROR`"
- [Example 12-13](#), "Handling FORALL Exceptions After FORALL Statement Completes"

Related Topics

In this chapter:

- ["Exception Declaration"](#)
- ["Exception Handler"](#)
- ["SQLCODE Function"](#)
- ["SQLERRM Function"](#)

In other chapters:

- ["Internally Defined Exceptions"](#)
- ["RAISE_APPLICATION_ERROR Procedure"](#)

13.26 Exception Declaration

An exception declaration declares the name of a user-defined exception.

You can use the `EXCEPTION_INIT` pragma to assign this name to an internally defined exception.

Topics

- [Syntax](#)
- [Semantics](#)
- [Examples](#)
- [Related Topics](#)

Syntax

exception_declaration ::=

→ (exception) → EXCEPTION → ;

Semantics

exception_declaration

exception

Name of the exception that you are declaring.

Restriction on *exception*

You can use *exception* only in an `EXCEPTION_INIT` pragma, `RAISE` statement, `RAISE_APPLICATION_ERROR` invocation, or exception handler.

Caution:

Oracle recommends against using a predefined exception name for *exception*. For details, see "[Redeclared Predefined Exceptions](#)". For a list of predefined exception names, see [Table 11-3](#).

Examples

- [Example 11-5](#), "Naming Internally Defined Exception"
- [Example 11-9](#), "Redeclared Predefined Identifier"
- [Example 11-10](#), "Declaring, Raising, and Handling User-Defined Exception"

Related Topics

In this chapter:

- ["EXCEPTION_INIT Pragma"](#)
- ["Exception Handler"](#)
- ["RAISE Statement"](#)

In other chapters:

- ["Internally Defined Exceptions"](#)
- ["User-Defined Exceptions"](#)

13.27 Exception Handler

An exception handler processes a raised exception.

Exception handlers appear in the exception-handling parts of anonymous blocks, subprograms, triggers, and packages.

Topics

- [Syntax](#)
- [Semantics](#)
- [Examples](#)

- [Related Topics](#)

Syntax

exception_handler ::=

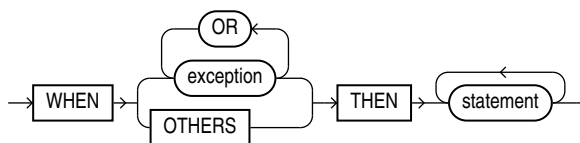

(*statement ::=*)

Semantics

exception_handler

exception

Name of either a predefined exception (see [Table 11-3](#)) or a user-defined exception (see ["Exception Declaration"](#)).

If PL/SQL raises a specified exception, then the associated statements run.

OTHERS

Specifies all exceptions not explicitly specified in the exception-handling part of the block. If PL/SQL raises such an exception, then the associated statements run.

Note:

Oracle recommends that the last statement in the `OTHERS` exception handler be either `RAISE` or an invocation of the `RAISE_APPLICATION_ERROR` procedure.

If you do not follow this practice, and PL/SQL warnings are enabled, you get PLW-06009.

In the exception-handling part of a block, the `WHEN OTHERS` exception handler is optional. It can appear only once, as the last exception handler in the exception-handling part of the block.

Examples

- [Example 11-3](#), "Single Exception Handler for Multiple Exceptions"
- [Example 11-4](#), "Locator Variables for Statements that Share Exception Handler"
- [Example 11-6](#), "Anonymous Block Handles `ZERO_DIVIDE`"
- [Example 11-7](#), "Anonymous Block Avoids `ZERO_DIVIDE`"
- [Example 11-10](#), "Declaring, Raising, and Handling User-Defined Exception"
- [Example 11-14](#), "Exception that Propagates Beyond Scope is Handled"
- [Example 11-24](#), "Exception Handler Runs and Execution Ends"

- [Example 11-25](#), "Exception Handler Runs and Execution Continues"
- [Example 12-12](#), "Handling FORALL Exceptions Immediately"
- [Example 12-13](#), "Handling FORALL Exceptions After FORALL Statement Completes"

Related Topics

In this chapter:

- ["Block"](#)
- ["EXCEPTION_INIT Pragma"](#)
- ["Exception Declaration"](#)
- ["RAISE Statement"](#)
- ["SQLCODE Function"](#)
- ["SQLERRM Function"](#)

In other chapters:

- ["Overview of Exception Handling"](#)
- ["Continuing Execution After Handling Exceptions"](#)
- ["Retrying Transactions After Handling Exceptions"](#)
- ["CREATE PACKAGE BODY Statement"](#)
- ["CREATE TRIGGER Statement"](#)

13.28 EXECUTE IMMEDIATE Statement

The `EXECUTE IMMEDIATE` statement builds and runs a dynamic SQL statement in a single operation.

Native dynamic SQL uses the `EXECUTE IMMEDIATE` statement to process most dynamic SQL statements.

Caution:

When using dynamic SQL, beware of SQL injection, a security risk. For more information about SQL injection, see ["SQL Injection"](#).

Topics

- [Syntax](#)
- [Semantics](#)
- [Examples](#)
- [Related Topics](#)

Syntax

execute_immediate_statement ::=

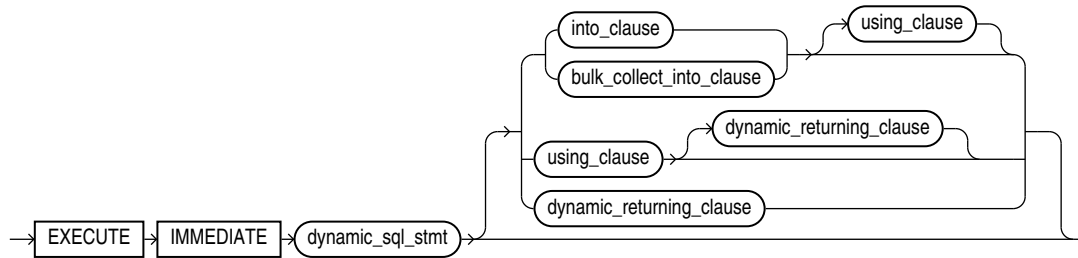

(bulk_collect_into_clause ::=, dynamic_returning_clause ::=, into_clause ::=)

using_clause ::=

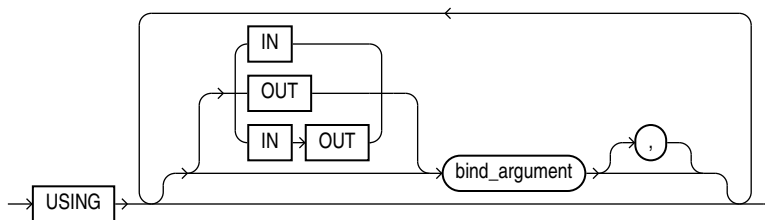

Semantics

execute_immediate_statement

dynamic_sql_stmt

String literal, string variable, or string expression that represents a SQL statement. Its type must be either CHAR, VARCHAR2, or CLOB.



Note:

If *dynamic_sql_statement* is a SELECT statement, and you omit both *into_clause* and *bulk_collect_into_clause*, then *execute_immediate_statement* never executes.

For example, this statement never increments the sequence:

```
EXECUTE IMMEDIATE 'SELECT S.NEXTVAL FROM DUAL'
```

into_clause

Specifies the variables or record in which to store the column values that the statement returns. For more information about this clause, see "[RETURNING INTO Clause](#)".

Restriction on *into_clause*

Use if and only if *dynamic_sql_stmt* returns a single row.

bulk_collect_into_clause

Specifies one or more collections in which to store the rows that the statement returns. For more information about this clause, see "[RETURNING INTO Clause](#)".

Restriction on *bulk_collect_into_clause*

Use if and only if *dynamic_sql_stmt* can return multiple rows.

dynamic_returning_clause

Returns the column values of the rows affected by the dynamic SQL statement, in either individual variables or records. For more information about this clause, see "[RETURNING INTO Clause](#)".

Restriction on *dynamic_returning_clause*

Use if and only if *dynamic_sql_stmt* has a RETURNING INTO clause.

using_clause

Specifies bind variables, using positional notation.

**Note:**

If you repeat placeholder names in *dynamic_sql_statement*, be aware that the way placeholders are associated with bind variables depends on the kind of dynamic SQL statement. For details, see "[Repeated Placeholder Names in Dynamic SQL Statements](#)".

Restrictions on *using_clause*

- Use if and only if *dynamic_sql_stmt* includes placeholders for bind variables.
- If *dynamic_sql_stmt* has a RETURNING INTO clause (*static_returning_clause*), then *using_clause* can contain only IN bind variables. The bind variables in the RETURNING INTO clause are OUT bind variables by definition.

IN, OUT, IN OUT

Parameter modes of bind variables. An IN bind variable passes its value to *dynamic_sql_stmt*. An OUT bind variable stores a value that *dynamic_sql_stmt* returns. An IN OUT bind variable passes its initial value to *dynamic_sql_stmt* and stores a value that *dynamic_sql_stmt* returns. **Default:** IN.

For DML a statement with a RETURNING clause, you can place OUT bind variables in the RETURNING INTO clause without specifying the parameter mode, which is always OUT.

bind_argument

An expression whose value replaces its corresponding placeholder in *dynamic_sql_stmt* at run time.

Every placeholder in *dynamic_sql_stmt* must be associated with a *bind_argument* in the USING clause or RETURNING INTO clause (or both) or with a define variable in the INTO clause.

You can run *dynamic_sql_stmt* repeatedly using different values for the bind variables. You incur some overhead, because EXECUTE IMMEDIATE prepares the dynamic string before every execution.

**Note:**

Bind variables can be evaluated in any order. If a program determines order of evaluation, then at the point where the program does so, its behavior is undefined.

Restrictions on *bind_argument*

- *bind_argument* cannot be an associative array indexed by string.
- *bind_argument* cannot be the reserved word NULL.

To pass the value NULL to the dynamic SQL statement, use an uninitialized variable where you want to use NULL, as in [Example 7-7](#).

Examples

- [Example 7-1](#), "Invoking Subprogram from Dynamic PL/SQL Block"
- [Example 7-7](#), "Uninitialized Variable Represents NULL in USING Clause"
- [Example 7-10](#), "Repeated Placeholder Names in Dynamic PL/SQL Block"

Related Topics

In this chapter:

- ["RETURNING INTO Clause"](#)

In other chapters:

- ["EXECUTE IMMEDIATE Statement"](#)
- ["DBMS_SQL Package"](#)

13.29 EXIT Statement

The EXIT statement exits the current iteration of a loop, either conditionally or unconditionally, and transfers control to the end of either the current loop or an enclosing labeled loop.

Restriction on EXIT Statement

An EXIT statement must be inside a LOOP statement.

Topics

- [Syntax](#)
- [Semantics](#)
- [Examples](#)

- [Related Topics](#)

Syntax

exit_statement ::=

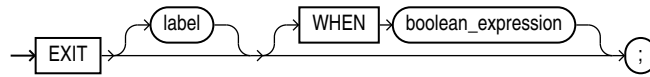

(boolean_expression ::=)

Semantics

exit_statement

label

Name that identifies either the current loop or an enclosing loop.

Without *label*, the EXIT statement transfers control to the end of the current loop. With *label*, the EXIT statement transfers control to the end of the loop that *label* identifies.

WHEN boolean_expression

Without this clause, the EXIT statement exits the current iteration of the loop unconditionally. With this clause, the EXIT statement exits the current iteration of the loop if and only if the value of *boolean_expression* is TRUE.

Examples

- [Example 4-9](#), "Basic LOOP Statement with EXIT Statement"
- [Example 4-10](#), "Basic LOOP Statement with EXIT WHEN Statement"
- [Example 4-11](#), "Nested, Labeled Basic LOOP Statements with EXIT WHEN Statements"
- [Example 4-25](#), "EXIT WHEN Statement in FOR LOOP Statement"
- [Example 4-26](#), "EXIT WHEN Statement in Inner FOR LOOP Statement"

Related Topics

In this chapter:

- ["Basic LOOP Statement"](#)
- ["CONTINUE Statement"](#)
- ["EXIT Statement"](#)
- ["EXIT WHEN Statement"](#)

13.30 Explicit Cursor Declaration and Definition

An **explicit cursor** is a named pointer to a private SQL area that stores information for processing a specific query or DML statement—typically, one that returns or affects multiple rows.

You can use an explicit cursor to retrieve the rows of a result set one at a time.

Before using an explicit cursor, you must declare and define it. You can either declare it first (with **cursor_declaration**) and then define it later in the same block, subprogram, or package (with **cursor_definition**) or declare and define it at the same time (with **cursor_definition**).

An explicit cursor declaration and definition are also called a **cursor specification** and **cursor body**, respectively.



Note:

An explicit cursor declared in a package specification is affected by the `AUTHID` clause of the package. For more information, see "[CREATE PACKAGE Statement](#)".

Topics

- [Syntax](#)
- [Semantics](#)
- [Examples](#)
- [Related Topics](#)

Syntax

cursor_declaration ::=

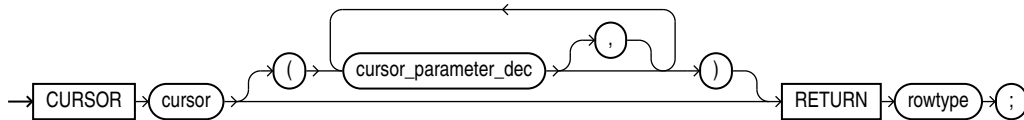

cursor_definition ::=

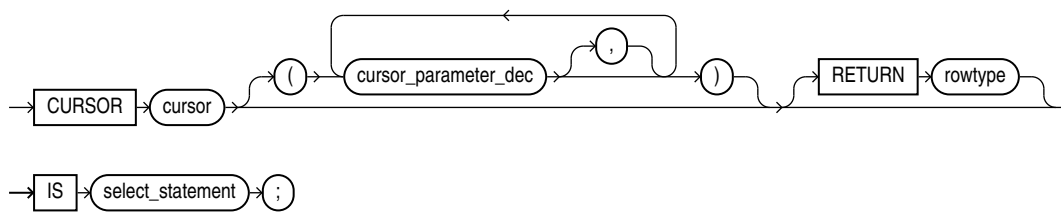

cursor_parameter_dec ::=

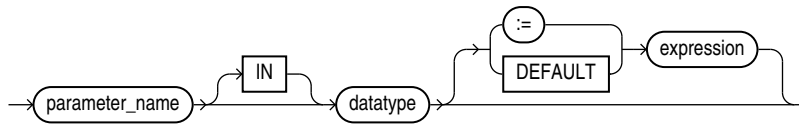

rowtype ::=

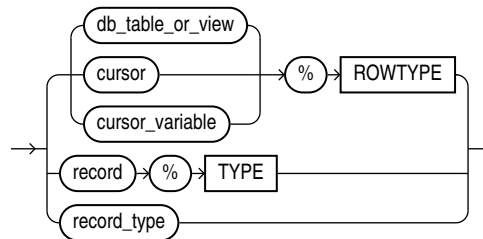

Semantics

cursor_declaration

cursor

Name of the explicit cursor that you are declaring now and will define later in the same block, subprogram, or package. *cursor* can be any identifier except the reserved word `SQL`. Oracle recommends against giving a cursor the same name as a database table.

Explicit cursor names follow the same scoping rules as variables (see "[Scope and Visibility of Identifiers](#)").

cursor_definition

Either defines an explicit cursor that was declared earlier or both declares and defines an explicit cursor.

cursor

Either the name of the explicit cursor that you previously declared and are now defining or the name of the explicit cursor that you are both declaring and defining. *cursor* can be any identifier except the reserved word `SQL`. Oracle recommends against giving a cursor the same name as a database table.

select_statement

A SQL `SELECT` statement (not a PL/SQL `SELECT INTO` statement). If the cursor has formal parameters, each parameter must appear in *select_statement*. The *select_statement* can also reference other PL/SQL variables in its scope.

Restriction on *select_statement*

This *select_statement* cannot have a `WITH` clause.

**See:***Oracle Database SQL Language Reference* for `SELECT` statement syntax***cursor_parameter_dec***

A cursor parameter declaration.

parameter

The name of the formal cursor parameter that you are declaring. This name can appear anywhere in *select_statement* that a constant can appear.

IN

Whether or not you specify `IN`, a formal cursor parameter has the characteristics of an `IN` subprogram parameter, which are summarized in [Table 8-1](#). When the cursor opens, the value of the formal parameter is that of either its actual parameter or default value.

datatype

The data type of the parameter.

Restriction on *datatype*

This *datatype* cannot have constraints (for example, `NOT NULL`, or precision and scale for a number, or length for a string).

expression

Specifies the default value for the formal cursor parameter. The data types of *expression* and the formal cursor parameter must be compatible.

If an `OPEN` statement does not specify an actual parameter for the formal cursor parameter, then the statement evaluates *expression* and assigns its value to the formal cursor parameter.

If an `OPEN` statement does specify an actual parameter for the formal cursor parameter, then the statement assigns the value of the actual parameter to the formal cursor parameter and does not evaluate *expression*.

rowtype

Data type of the row that the cursor returns. The columns of this row must match the columns of the row that *select_statement* returns.

db_table_or_view

Name of a database table or view, which must be accessible when the declaration is elaborated.

cursor

Name of a previously declared explicit cursor.

cursor_variable

Name of a previously declared cursor variable.

record

Name of a previously declared record variable.

record_type

Name of a user-defined type that was defined with the data type specifier `RECORD`.

Examples

- [Example 6-5](#), "Explicit Cursor Declaration and Definition"
- [Example 6-8](#), "Variable in Explicit Cursor Query—No Result Set Change"
- [Example 6-9](#), "Variable in Explicit Cursor Query—Result Set Change"
- [Example 6-10](#), "Explicit Cursor with Virtual Column that Needs Alias"
- [Example 6-11](#), "Explicit Cursor that Accepts Parameters"
- [Example 6-12](#), "Cursor Parameters with Default Values"
- [Example 6-13](#), "Adding Formal Parameter to Existing Cursor"
- [Example 6-22](#), "Subquery in FROM Clause of Parent Query"
- [Example 6-23](#), "Correlated Subquery"
- [Example 6-35](#), "CURSOR Expression"
- [Example 6-41](#), "FETCH with FOR UPDATE Cursor After COMMIT Statement"

Related Topics

In this chapter:

- ["CLOSE Statement"](#)
- ["Cursor FOR LOOP Statement"](#)
- ["Cursor Variable Declaration"](#)
- ["FETCH Statement"](#)
- ["Named Cursor Attribute"](#)
- ["OPEN Statement"](#)
- ["%ROWTYPE Attribute"](#)
- ["%TYPE Attribute"](#)

In other chapters:

- ["Explicit Cursors"](#)
- ["Processing Query Result Sets"](#)
- ["SELECT FOR UPDATE and FOR UPDATE Cursors"](#)

13.31 Expression

An expression is an arbitrarily complex combination of operands (variables, constants, literals, operators, function invocations, and placeholders) and operators.

The simplest expression is a single variable.

The PL/SQL compiler determines the data type of an expression from the types of the operands and operators that comprise the expression. Every time the expression is evaluated, a single value of that type results.

Topics

- [Syntax](#)
- [Semantics](#)
- [Examples](#)
- [Related Topics](#)

Syntax

expression ::=

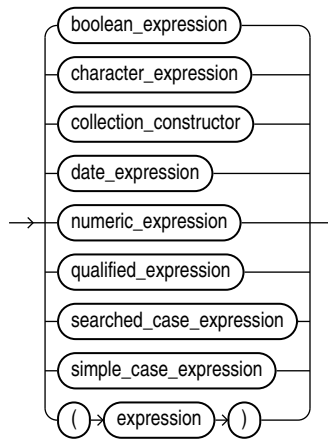

(*boolean_expression ::=, character_expression ::=, collection_constructor ::=, date_expression ::=, numeric_expression ::=, qualified_expression ::=, searched_case_expression ::=, simple_case_expression ::=*)

boolean_expression ::=

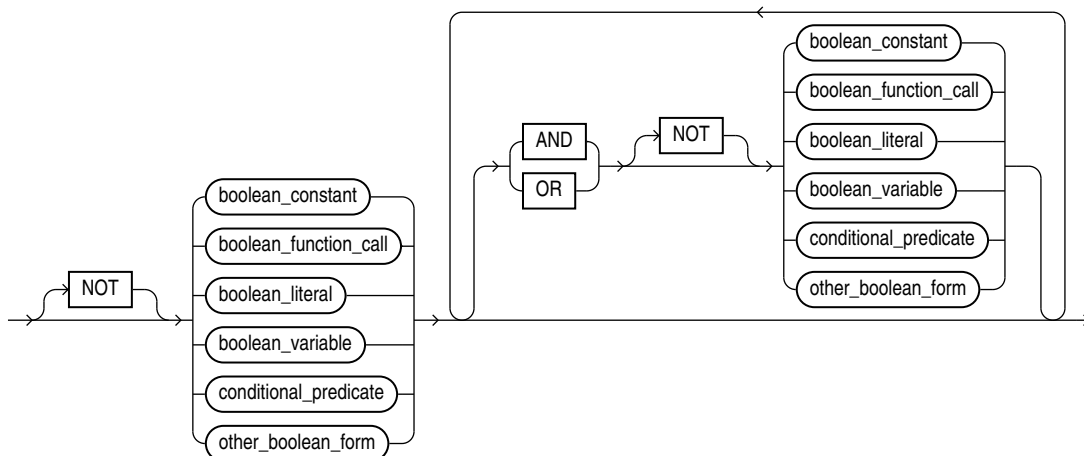

(function_call ::=)

boolean_literal ::=

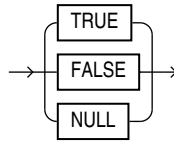

conditional_predicate ::=

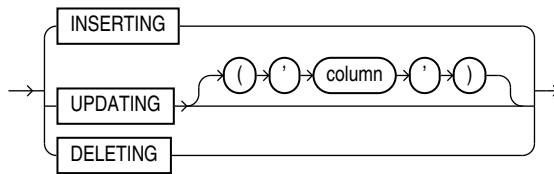

other_boolean_form ::=

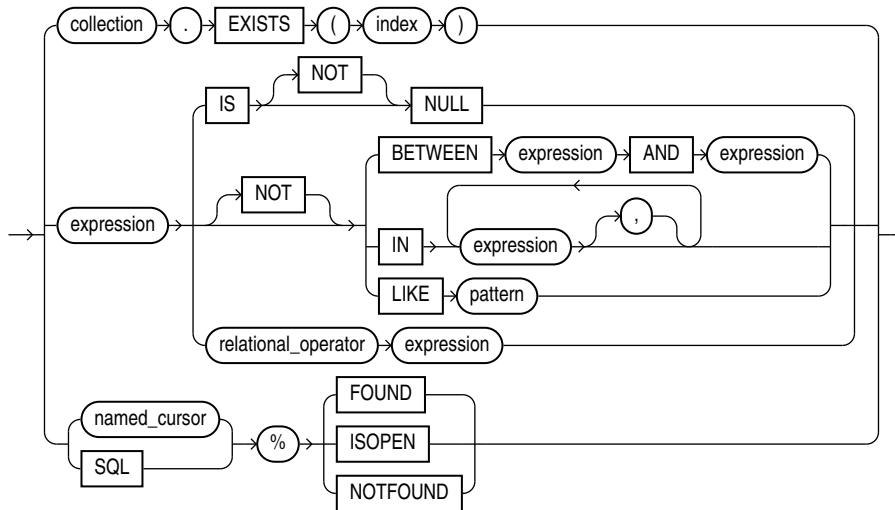

(expression ::=, named_cursor ::=)

character_expression ::=

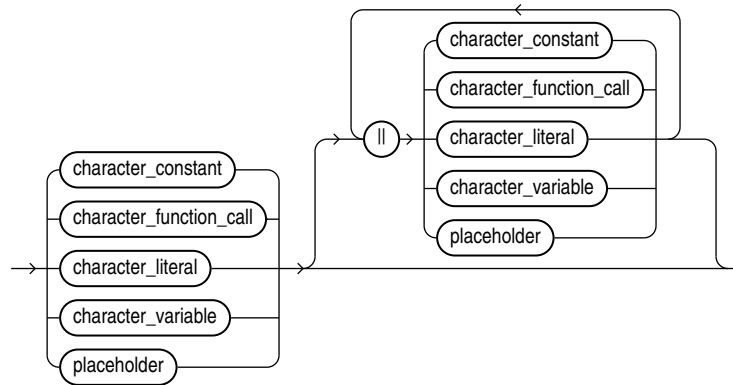

(function_call ::=, placeholder ::=)

collection_constructor ::=

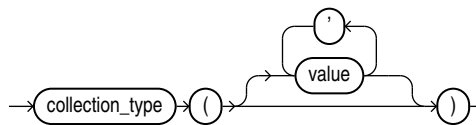

date_expression ::=

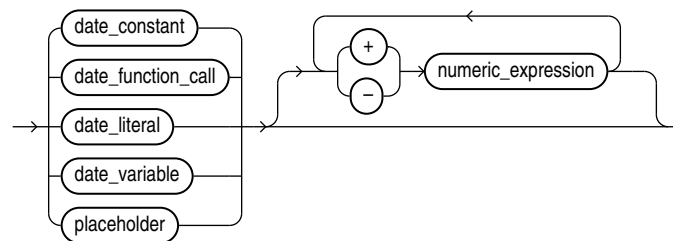

(function_call ::=, placeholder ::=)

numeric_expression ::=

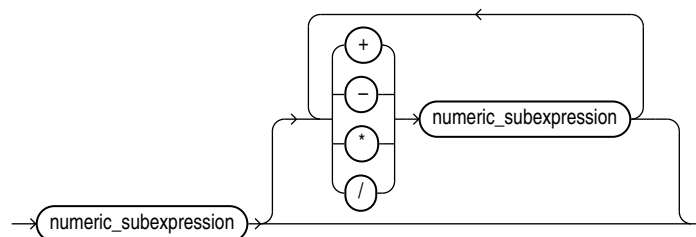

numeric_subexpression ::=

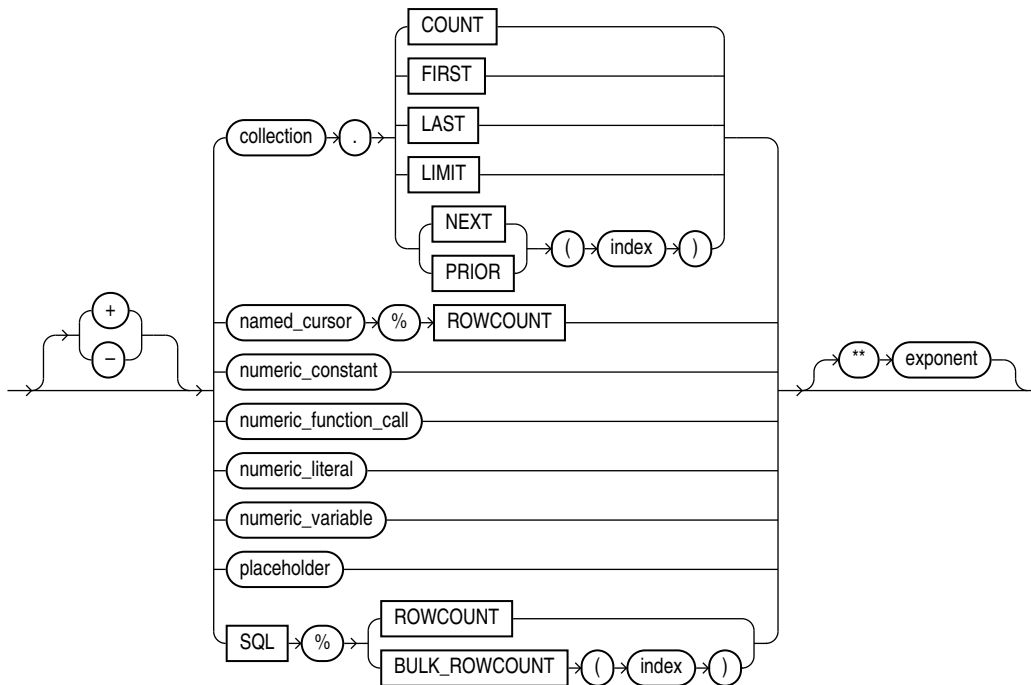

(function_call ::=, named_cursor ::=, placeholder ::=)

function_call ::=

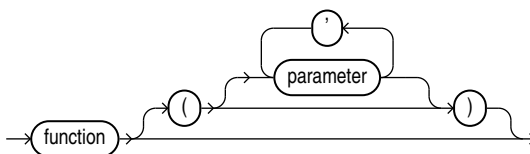

qualified_expression ::=

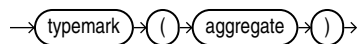

typemark ::=

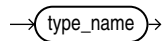

type_name ::=

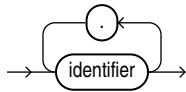

aggregate ::=

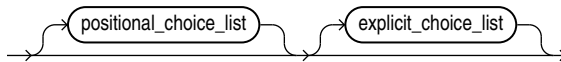

positional_choice_list ::=

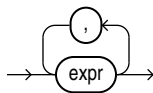

explicit_choice_list ::=

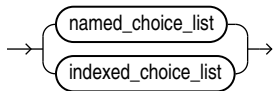

named_choice_list ::=

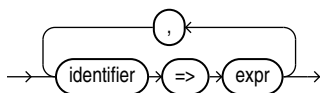

indexed_choice_list ::=

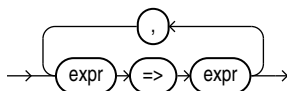

searched_case_expression ::=

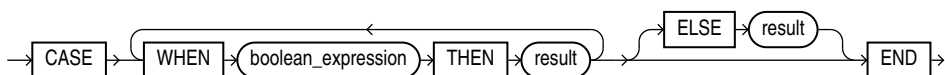

(boolean_expression ::=)

simple_case_expression ::=

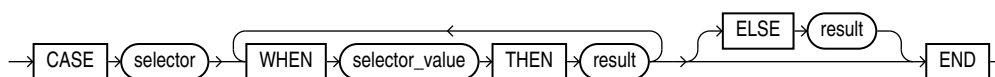

Semantics

boolean_expression

Expression whose value is `TRUE`, `FALSE`, or `NULL`. For more information, see "[BOOLEAN Expressions](#)".

Restriction on *boolean_expression*

Because SQL has no data type equivalent to `BOOLEAN`, you cannot:

- Assign a `BOOLEAN` value to a database table column
- Select or fetch the value of a database table column into a `BOOLEAN` variable
- Use a `BOOLEAN` value in a SQL function

(However, a SQL query can invoke a PL/SQL function that has a `BOOLEAN` parameter, as in [Example 3-3](#).)

- Use a `BOOLEAN` expression in a SQL statement, except as an argument to a PL/SQL function invoked in a SQL query, or in a PL/SQL anonymous block.

Note:

An argument to a PL/SQL function invoked in a static SQL query cannot be a `BOOLEAN` literal. The workaround is to assign the literal to a variable and then pass the variable to the function, as in [Example 3-3](#).

NOT, AND, OR

See "[Logical Operators](#)".

boolean_constant

Name of a constant of type `BOOLEAN`.

boolean_function_call

Invocation of a previously defined function that returns a `BOOLEAN` value. For more semantic information, see "[function_call](#)".

boolean_variable

Name of a variable of type `BOOLEAN`.

conditional_predicate

See "[Conditional Predicates for Detecting Triggering DML Statement](#)".

other_boolean_form***collection***

Name of a collection variable.

EXISTS

Collection method (function) that returns `TRUE` if the *index*th element of *collection* exists and `FALSE` otherwise. For more information, see "[EXISTS Collection Method](#)".

Restriction on EXISTS

You cannot use `EXISTS` if *collection* is an associative array.

index

Numeric expression whose data type either is `PLS_INTEGER` or can be implicitly converted to `PLS_INTEGER` (for information about the latter, see "[Predefined PLS_INTEGER Subtypes](#)").

IS [NOT] NULL

See "[IS \[NOT\] NULL Operator](#)".

BETWEEN *expression* AND *expression*

See "[BETWEEN Operator](#)".

IN *expression* [, *expression*]...

See "[IN Operator](#)".

LIKE *pattern*

See "[LIKE Operator](#)".

relational_operator

See "[Relational Operators](#)".

SQL

Implicit cursor associated with the most recently run `SELECT` or `DML` statement. For more information, see "[Implicit Cursors](#)".

%FOUND, %ISOPEN, %NOTFOUND

Cursor attributes explained in "[Implicit Cursor Attribute](#)" and "[Named Cursor Attribute](#)".

character_expression

Expression whose value has a character data type (that is, a data type in the `CHAR` family, described in "[CHAR Data Type Family](#)").

character_constant

Name of a constant that has a character data type.

character_function_call

Invocation of a previously defined function that returns a value that either has a character data type or can be implicitly converted to a character data type. For more semantic information, see "[function_call](#)".

character_literal

Literal of a character data type.

character_variable

Name of a variable that has a character data type.

||

Concatenation operator, which appends one string operand to another. For more information, see "[Concatenation Operator](#)".

collection_constructor

Constructs a collection of the specified type with elements that have the specified values.

For more information, see "[Collection Constructors](#)".

collection_type

Name of a previously declared nested table type or `VARRAY` type (not an associative array type).

value

Valid value for an element of a collection of *collection_type*.

If *collection_type* is a varray type, then it has a maximum size, which the number of values cannot exceed. If *collection_type* is a nested table type, then it has no maximum size.

If you specify no values, then the constructed collection is empty but not null (for the difference between *empty* and *null*, see "[Collection Types](#)").

date_expression

Expression whose value has a date data type (that is, a data type in the `DATE` family, described in "[DATE Data Type Family](#)").

date_constant

Name of a constant that has a date data type.

date_function_call

Invocation of a previously defined function that returns a value that either has a date data type or can be implicitly converted to a date data type. For more semantic information, see "[function_call](#)".

date_literal

Literal whose value either has a date data type or can be implicitly converted to a date data type.

date_variable

Name of a variable that has a date data type.

+, -

Addition and subtraction operators.

numeric_expression

Expression whose value has a date numeric type (that is, a data type in the `DATE` family, described in "[NUMBER Data Type Family](#)").

+, -, /, *, **

Addition, subtraction, division, multiplication, and exponentiation operators.

numeric_subexpression***collection***

Name of a collection variable.

COUNT, FIRST, LAST, LIMIT, NEXT, PRIOR

Collection methods explained in "[Collection Method Invocation](#)".

named_cursor%ROWCOUNT

See "[Named Cursor Attribute](#)".

numeric_constant

Name of a constant that has a numeric data type.

numeric_function_call

Invocation of a previously defined function that returns a value that either has a numeric data type or can be implicitly converted to a numeric data type. For more semantic information, see "[function_call](#)".

numeric_literal

Literal of a numeric data type.

numeric_variable

Name of variable that has a numeric data type.

SQL%ROWCOUNT

Cursor attribute explained in "[Implicit Cursor Attribute](#)".

SQL%BULK_ROWCOUNT]

Cursor attribute explained in "[SQL%BULK_ROWCOUNT](#)".

exponent

Numeric expression.

function_call***function***

Name of a previously defined function.

parameter [, parameter]...

List of actual parameters for the function being called. The data type of each actual parameter must be compatible with the data type of the corresponding formal parameter. The mode of the formal parameter determines what the actual parameter can be:

Formal Parameter Mode	Actual Parameter
IN	Constant, initialized variable, literal, or expression
OUT	Variable whose data type is not defined as NOT NULL
IN OUT	Variable (typically, it is a string buffer or numeric accumulator)

If the function specifies a default value for a parameter, you can omit that parameter from the parameter list. If the function has no parameters, or specifies a default value for every parameter, you can either omit the parameter list or specify an empty parameter list.



See Also:

["Positional, Named, and Mixed Notation for Actual Parameters"](#)

qualified_expression

Qualified expressions for `RECORD` types are allowed in any context where an expression of `RECORD` type is allowed.

Qualified expressions for associative array types are allowed in any context where an expression of associative array type is allowed.

typemark (aggregate)

Specifies explicitly the type of the aggregate (qualified items).

typemark

Qualified expressions use an explicit type indication to provide the type of the qualified item. This explicit indication is known as a *typemark*.

type_name

identifier [.]

Indicates the type of the qualified item.

aggregate

A qualified expression combines expression elements to create values of a `RECORD` type, or associative array type.

positional_choice_list

expr [,]

Positional association is allowed for qualified expressions of `RECORD` type.

A positional association may not follow a named association in the same construct (and vice versa).

explicit_choice_list

named_choice_list* | *indexed_choice_list

Named choices must use names of fields from the qualifying structure type. Index key values must be compatible with the index type for the qualifying vector type.

named_choice_list

A named choice applies only to structured types

***identifier* => *expr* [,]**

Named association is allowed for qualified expressions of `RECORD` type.

indexed_choice_list

An index choice applies only to vector types.

***expr* => *expr* [,]**

Indexed choices (key-value pairs) is allowed for qualified expressions of associative array types. Both the key and the value may be expressions.

Using `NULL` as an index key value is not permitted with associative array type constructs.

searched_case_expression

WHEN *boolean_expression* THEN *result*

The *boolean_expressions* are evaluated sequentially. If a *boolean_expression* has the value `TRUE`, then the *result* associated with that *boolean_expression* is returned. Subsequent *boolean_expressions* are not evaluated.

ELSE *result*

The *result* is returned if and only if no *boolean_expression* has the value `TRUE`.

If you omit the `ELSE` clause, the searched case expression returns `NULL`.



See Also:

["Searched CASE Statement"](#)

simple_case_expression

selector

An expression of any PL/SQL type except `BLOB`, `BFILE`, or a user-defined type. The *selector* is evaluated once.

WHEN *selector_value* THEN *result*

The *selector_values* are evaluated sequentially. If a *selector_value* is the value of *selector*, then the *result* associated with that *selector_value* is returned. Subsequent *selector_values* are not evaluated.

A *selector_value* can be of any PL/SQL type except BLOB, BFILE, an ADT, a PL/SQL record, an associative array, a varray, or a nested table.

ELSE result

The *result* is returned if and only if no *selector_value* has the same value as *selector*.

If you omit the ELSE clause, the simple case expression returns NULL.



Note:

If you specify the literal NULL for every *result* (including the *result* in the ELSE clause), then error PLS-00617 occurs.



See Also:

"Simple CASE Statement"

Examples

- [Example 2-28](#), "Concatenation Operator Examples"
- [Example 2-30](#), "Controlling Evaluation Order with Parentheses"
- [Example 2-31](#), "Expression with Nested Parentheses"
- [Example 2-32](#), "Improving Readability with Parentheses"
- [Example 2-33](#), "Operator Precedence"
- [Example 2-43](#), "Relational Operators in Expressions"
- [Example 2-44](#), "LIKE Operator in Expression"
- [Example 2-46](#), "BETWEEN Operator in Expressions"
- [Example 2-47](#), "IN Operator in Expressions"
- [Example 2-50](#), "Simple CASE Expression"
- [Example 2-52](#), "Searched CASE Expression"
- [Example 9-1](#), "Trigger Uses Conditional Predicates to Detect Triggering Statement"

Related Topics

In this chapter:

- ["Collection Method Invocation"](#)
- ["Constant Declaration"](#)

- ["Scalar Variable Declaration"](#)

In other chapters:

- ["Qualified Expressions Overview"](#) for more information and examples
- ["Literals"](#)
- ["Expressions"](#)
- ["Operator Precedence"](#)
- ["PL/SQL Data Types"](#)
- ["Subprogram Parameters"](#)

13.32 FETCH Statement

The `FETCH` statement retrieves rows of data from the result set of a multiple-row query—one row at a time, several rows at a time, or all rows at once—and stores the data in variables, records, or collections.

Topics

- [Syntax](#)
- [Semantics](#)
- [Examples](#)
- [Related Topics](#)

Syntax

fetch_statement ::=

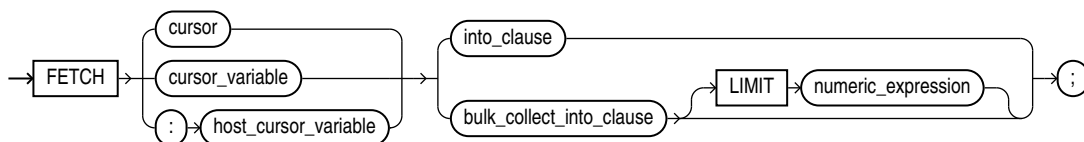

(bulk_collect_into_clause ::=, into_clause ::=, numeric_expression ::=)

Semantics

fetch_statement

cursor

Name of an open explicit cursor. To open an explicit cursor, use the ["OPEN Statement"](#).

If you try to fetch from an explicit cursor before opening it or after closing it, PL/SQL raises the predefined exception `INVALID_CURSOR`.

cursor_variable

Name of an open cursor variable. To open a cursor variable, use the ["OPEN FOR Statement"](#). The cursor variable can be a formal subprogram parameter (see ["Cursor Variables as Subprogram Parameters"](#)).

If you try to fetch from a cursor variable before opening it or after closing it, PL/SQL raises the predefined exception `INVALID_CURSOR`.

:host_cursor_variable

Name of a cursor variable declared in a PL/SQL host environment, passed to PL/SQL as a bind variable, and then opened. To open a host cursor variable, use the "[OPEN FOR Statement](#)". Do not put space between the colon (:) and *host_cursor_variable*.

The data type of a host cursor variable is compatible with the return type of any PL/SQL cursor variable.

into_clause

To have the `FETCH` statement retrieve one row at a time, use this clause to specify the variables or record in which to store the column values of a row that the cursor returns. For more information about *into_clause*, see "[into_clause ::=](#)".

***bulk_collect_into_clause* [`LIMIT numeric_expression`]**

Use *bulk_collect_into_clause* to specify one or more collections in which to store the rows that the `FETCH` statement returns. For more information about *bulk_collect_into_clause*, see "[bulk_collect_into_clause ::=](#)".

To have the `FETCH` statement retrieve all rows at once, omit `LIMIT numeric_expression`.

To limit the number of rows that the `FETCH` statement retrieves at once, specify `LIMIT numeric_expression`.

Restrictions on *bulk_collect_into_clause*

- You cannot use *bulk_collect_into_clause* in client programs.
- When the `FETCH` statement requires implicit data type conversions, *bulk_collect_into_clause* can have only one *collection* or *host_array*.

Examples

- [Example 5-51](#), "FETCH Assigns Values to Record that Function Returns"
- [Example 6-6](#), "FETCH Statements Inside LOOP Statements"
- [Example 6-7](#), "Fetching Same Explicit Cursor into Different Variables"
- [Example 6-26](#), "Fetching Data with Cursor Variables"
- [Example 6-27](#), "Fetching from Cursor Variable into Collections"
- [Example 6-41](#), "FETCH with FOR UPDATE Cursor After COMMIT Statement"
- [Example 7-8](#), "Native Dynamic SQL with OPEN FOR, FETCH, and CLOSE Statements"
- [Example 12-22](#), "Bulk-Fetching into Two Nested Tables"
- [Example 12-23](#), "Bulk-Fetching into Nested Table of Records"
- [Example 12-24](#), "Limiting Bulk FETCH with LIMIT"

Related Topics

In this chapter:

- "Assignment Statement"
- "CLOSE Statement"
- "Cursor Variable Declaration"
- "Explicit Cursor Declaration and Definition"
- "OPEN Statement"
- "OPEN FOR Statement"
- "RETURNING INTO Clause"
- "%ROWTYPE Attribute"
- "SELECT INTO Statement"
- "%TYPE Attribute"

In other chapters:

- "Using FETCH to Assign a Row to a Record Variable"
- "Fetching Data with Explicit Cursors"
- "Processing Query Result Sets With Cursor FOR LOOP Statements"
- "Fetching Data with Cursor Variables"
- "OPEN FOR, FETCH, and CLOSE Statements"
- "FETCH Statement with BULK COLLECT Clause"
- "Fetching from Results of Pipelined Table Functions"

13.33 FOR LOOP Statement

With each iteration of the `FOR LOOP` statement, its statements run, its index is either incremented or decremented, and control returns to the top of the loop. The `FOR LOOP` statement ends when its index reaches a specified value, or when a statement inside the loop transfers control outside the loop or raises an exception.

Topics

- [Syntax](#)
- [Semantics](#)
- [Examples](#)
- [Related Topics](#)

Syntax

for_loop_statement ::=

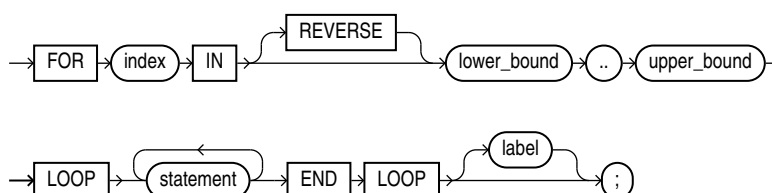

(*statement* ::=)

Semantics

for_loop_statement

index

Name for the implicitly declared integer variable that is local to the FOR LOOP statement. Statements outside the loop cannot reference *index*. Statements inside the loop can reference *index*, but cannot change its value. After the FOR LOOP statement runs, *index* is undefined.



See Also:

"FOR LOOP Index"

[REVERSE] *lower_bound* .. *upper_bound*

lower_bound and *upper_bound* must evaluate to numbers (see "[Lower Bound and Upper Bound](#)"). PL/SQL evaluates *lower_bound* and *upper_bound* once, when the FOR LOOP statement is entered, and stores them as temporary PLS_INTEGER values, rounding them to the nearest integer if necessary.

If *lower_bound* equals *upper_bound*, the *statements* run only once.

If *lower_bound* does not equal *upper_bound* when the FOR LOOP statement begins to run, then:

- If REVERSE is omitted:

If *lower_bound* is greater than *upper_bound*, the *statements* do not run, and control transfers to the statement after the FOR LOOP statement.

Otherwise, *lower_bound* is assigned to *index*, the *statements* run, and control returns to the top of the loop, where *index* is compared to *upper_bound*. If *index* is less than *upper_bound*, *index* is incremented by one, the *statements* run again, and control returns to the top of the loop. When *index* is greater than *upper_bound*, control transfers to the statement after the FOR LOOP statement.

- If REVERSE is specified:

If *upper_bound* is less than *lower_bound*, the *statements* do not run, and control transfers to the statement after the FOR LOOP statement.

Otherwise, *upper_bound* is assigned to *index*, the *statements* run, and control returns to the top of the loop, where *index* is compared to *lower_bound*. If *index* is greater than *lower_bound*, *index* is decremented by one, the *statements* run again, and control returns to the top of the loop. When *index* is less than *lower_bound*, control transfers to the statement after the FOR LOOP statement.

label

A label that identifies *for_loop_statement* (see "[statement ::=](#)" and "[label](#)"). CONTINUE, EXIT, and GOTO statements can reference this label.

Labels improve readability, especially when `LOOP` statements are nested, but only if you ensure that the label in the `END LOOP` statement matches a label at the beginning of the same `LOOP` statement (the compiler does not check).

Examples

- [Example 4-15](#), "FOR LOOP Statements"
- [Example 4-16](#), "Reverse FOR LOOP Statements"
- [Example 4-17](#), "Simulating STEP Clause in FOR LOOP Statement"
- [Example 4-19](#), "Outside Statement References FOR LOOP Statement Index"
- [Example 4-20](#), "FOR LOOP Statement Index with Same Name as Variable"
- [Example 4-21](#), "FOR LOOP Statement References Variable with Same Name as Index"
- [Example 4-22](#), "Nested FOR LOOP Statements with Same Index Name"
- [Example 4-23](#), "FOR LOOP Statement Bounds"
- [Example 4-24](#), "Specifying FOR LOOP Statement Bounds at Run Time"

Related Topics

In this chapter:

- ["Basic LOOP Statement"](#)
- ["CONTINUE Statement"](#)
- ["Cursor FOR LOOP Statement"](#)
- ["EXIT Statement"](#)
- ["FETCH Statement"](#)
- ["FORALL Statement"](#)
- ["OPEN Statement"](#)
- ["WHILE LOOP Statement"](#)

In other chapters:

- ["FOR LOOP Statement"](#)

13.34 FORALL Statement

The `FORALL` statement runs one DML statement multiple times, with different values in the `VALUES` and `WHERE` clauses.

The different values come from existing, populated collections or host arrays. The `FORALL` statement is usually much faster than an equivalent `FOR LOOP` statement.



Note:

You can use the `FORALL` statement only in server programs, not in client programs.

Topics

- [Syntax](#)
- [Semantics](#)
- [Examples](#)
- [Related Topics](#)

Syntax

***forall_statement* ::=**

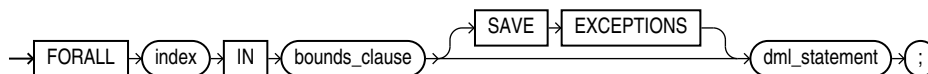

***bounds_clause* ::=**

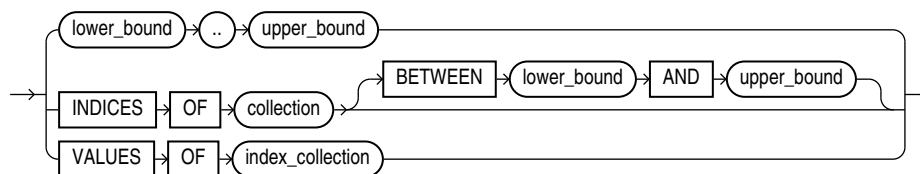

Semantics

forall_statement

index

Name for the implicitly declared integer variable that is local to the `FORALL` statement. Statements outside the `FORALL` statement cannot reference *index*. Statements inside the `FORALL` statement can reference *index* as an index variable, but cannot use it in expressions or change its value. After the `FORALL` statement runs, *index* is undefined.

dml_statement

A static or dynamic `INSERT`, `UPDATE`, `DELETE`, or `MERGE` statement that references at least one collection in its `VALUES` or `WHERE` clause. Performance benefits apply only to collection references that use *index* as an index.

Every collection that *dml_statement* references must have indexes that match the values of *index*. If you apply the `DELETE`, `EXTEND`, or `TRIM` method to one collection, apply it to the other collections also, so that all collections have the same set of indexes. If any collection lacks a referenced element, PL/SQL raises an exception.

Restriction on *dml_statement*

If *dml_statement* is a dynamic SQL statement, then values in the `USING` clause (bind variables for the dynamic SQL statement) must be simple references to the collection, not expressions. For example, `collection(i)` is valid, but `UPPER(collection(i))` is invalid.

SAVE EXCEPTIONS

Lets the `FORALL` statement continue even if some of its DML statements fail. For more information, see "[Handling FORALL Exceptions After FORALL Statement Completes](#)".

bounds_clause

Specifies the collection element indexes that provide values for the variable *index*. For each value, the SQL engine runs *dml_statement* once.

lower_bound .. upper_bound

Both *lower_bound* and *upper_bound* are numeric expressions that PL/SQL evaluates once, when the `FORALL` statement is entered, and rounds to the nearest integer if necessary. The resulting integers must be the lower and upper bounds of a valid range of consecutive index numbers. If an element in the range is missing or was deleted, PL/SQL raises an exception.

INDICES OF *collection* [BETWEEN *lower_bound* AND *upper_bound*]

Specifies that the values of *index* correspond to the indexes of the elements of *collection*. The indexes need not be consecutive.

Both *lower_bound* and *upper_bound* are numeric expressions that PL/SQL evaluates once, when the `FORALL` statement is entered, and rounds to the nearest integer if necessary. The resulting integers are the lower and upper bounds of a valid range of index numbers, which need not be consecutive.

Restriction on *collection*

If *collection* is an associative array, it must be indexed by `PLS_INTEGER`.

VALUES OF *index_collection*

Specifies that the values of *index* are the elements of *index_collection*, a collection of `PLS_INTEGER` elements that is indexed by `PLS_INTEGER`. The indexes of *index_collection* need not be consecutive. If *index_collection* is empty, PL/SQL raises an exception and the `FORALL` statement does not run.

Examples

- [Example 12-8](#), "DELETE Statement in FORALL Statement"
- [Example 12-9](#), "Time Difference for INSERT Statement in FOR LOOP and FORALL Statements"
- [Example 12-10](#), "FORALL Statement for Subset of Collection"
- [Example 12-11](#), "FORALL Statements for Sparse Collection and Its Subsets"
- [Example 12-12](#), "Handling FORALL Exceptions Immediately"
- [Example 12-13](#), "Handling FORALL Exceptions After FORALL Statement Completes"
- [Example 12-26](#), "DELETE with RETURN BULK COLLECT INTO in FORALL Statement"
- [Example 12-28](#), "Anonymous Block Bulk-Binds Input Host Array"

Related Topics

In this chapter:

- ["FOR LOOP Statement"](#)

- ["Implicit Cursor Attribute"](#)

In other chapters:

- ["FORALL Statement"](#)
- ["BULK COLLECT Clause"](#)
- ["Using FORALL Statement and BULK COLLECT Clause Together"](#)

13.35 Formal Parameter Declaration

A formal parameter declaration specifies the name and data type of the parameter, and (optionally) its mode and default value.

A formal parameter declaration can appear in the following:

- ["Function Declaration and Definition"](#)
- ["Procedure Declaration and Definition"](#)
- ["CREATE FUNCTION Statement"](#)
- ["CREATE PROCEDURE Statement"](#)

Topics

- [Syntax](#)
- [Semantics](#)
- [Examples](#)
- [Related Topics](#)

Syntax

parameter_declaration ::=

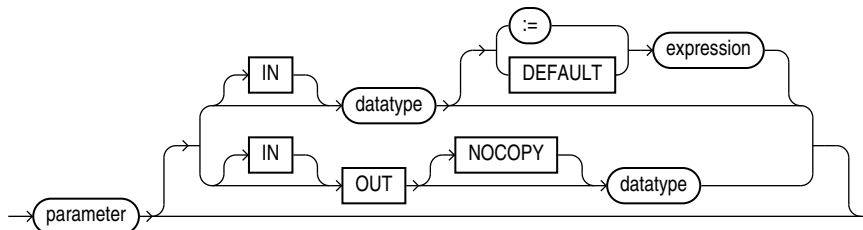

Semantics

parameter_declaration

parameter

Name of the formal parameter that you are declaring, which you can reference in the executable part of the subprogram.

IN, OUT, IN OUT

Mode that determines the behavior of the parameter, explained in "[Subprogram Parameter Modes](#)". **Default:** IN.

 **Note:**

Avoid using `OUT` and `IN OUT` for function parameters. The purpose of a function is to take zero or more parameters and return a single value. Functions must be free from side effects, which change the values of variables not local to the subprogram.

NOCOPY

Requests that the compiler pass the corresponding actual parameter by reference instead of value (for the difference, see "[Subprogram Parameter Passing Methods](#)"). Each time the subprogram is invoked, the optimizer decides, silently, whether to obey or disregard `NOCOPY`.

 **Caution:**

`NOCOPY` increases the likelihood of aliasing. For details, see "[Subprogram Parameter Aliasing with Parameters Passed by Reference](#)".

The compiler ignores `NOCOPY` in these cases:

- The actual parameter must be implicitly converted to the data type of the formal parameter.
- The actual parameter is the element of a collection.
- The actual parameter is a scalar variable with the `NOT NULL` constraint.
- The actual parameter is a scalar numeric variable with a range, size, scale, or precision constraint.
- The actual and formal parameters are records, one or both was declared with `%ROWTYPE` or `%TYPE`, and constraints on corresponding fields differ.
- The actual and formal parameters are records, the actual parameter was declared (implicitly) as the index of a cursor `FOR LOOP` statement, and constraints on corresponding fields differ.
- The subprogram is invoked through a database link or as an external subprogram.

 **Note:**

The preceding list might change in a subsequent release.

datatype

Data type of the formal parameter that you are declaring. The data type can be a constrained subtype, but cannot include a constraint (for example, `NUMBER(2)` or `VARCHAR2(20)`).

If *datatype* is a constrained subtype, the corresponding actual parameter inherits the `NOT NULL` constraint of the subtype (if it has one), but not the size (see [Example 8-10](#)).

 **Caution:**

The data type `REF CURSOR` increases the likelihood of subprogram parameter aliasing, which can have unintended results. For more information, see ["Subprogram Parameter Aliasing with Cursor Variable Parameters"](#).

expression

Default value of the formal parameter that you are declaring. The data type of *expression* must be compatible with *datatype*.

If a subprogram invocation does not specify an actual parameter for the formal parameter, then that invocation evaluates *expression* and assigns its value to the formal parameter.

If a subprogram invocation does specify an actual parameter for the formal parameter, then that invocation assigns the value of the actual parameter to the formal parameter and does not evaluate *expression*.

Examples

- [Example 2-26](#), "Assigning Value to Variable as IN OUT Subprogram Parameter"
- [Example 8-9](#), "Formal Parameters and Actual Parameters"
- [Example 8-14](#), "Parameter Values Before, During, and After Procedure Invocation"
- [Example 8-15](#), "OUT and IN OUT Parameter Values After Exception Handling"
- [Example 8-20](#), "Procedure with Default Parameter Values"
- [Example 8-21](#), "Function Provides Default Parameter Value"
- [Example 8-22](#), "Adding Subprogram Parameter Without Changing Existing Invocations"

Related Topics

In this chapter:

- ["Function Declaration and Definition"](#)
- ["Procedure Declaration and Definition"](#)

In other chapters:

- ["Subprogram Parameters"](#)
- ["Tune Subprogram Invocations"](#)
- ["CREATE FUNCTION Statement"](#)
- ["CREATE PROCEDURE Statement"](#)

13.36 Function Declaration and Definition

Before invoking a function, you must declare and define it. You can either declare it first (with ***function_declaration***) and then define it later in the same block,

subprogram, or package (with **function_definition**) or declare and define it at the same time (with **function_definition**).

A **function** is a subprogram that returns a value. The data type of the value is the data type of the function. A function invocation (or call) is an expression, whose data type is that of the function.

A function declaration is also called a **function specification** or **function spec**.

 **Note:**

This topic applies to nested functions.

For information about standalone functions, see "[CREATE FUNCTION Statement](#)".

For information about package functions, see "[CREATE PACKAGE Statement](#)".

Topics

- [Syntax](#)
- [Semantics](#)
- [Examples](#)
- [Related Topics](#)

Syntax

function_declaration ::=

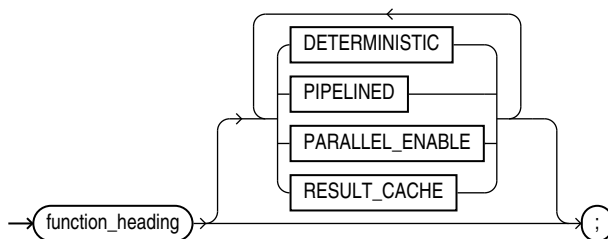

function_heading ::=

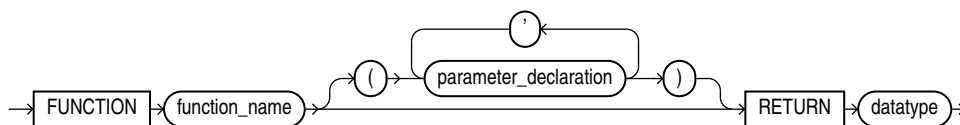

(*datatype ::=* , *parameter_declaration ::=*)

function_definition ::=

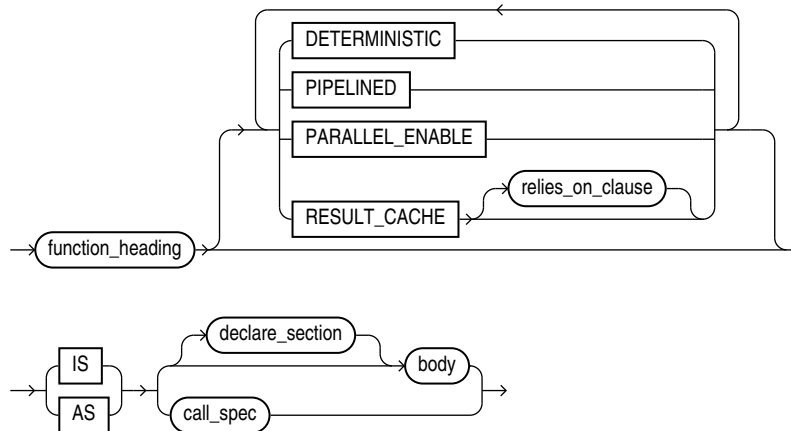

(*body* ::= , *declare_section* ::= , *pipelined_clause* ::= , *deterministic_clause* ::= ,
parallel_enable_clause ::= , *result_cache_clause* ::= , *call_spec* ::=)

Semantics

function_declaration

Declares a function, but does not define it. The definition must appear later in the same block, subprogram, or package as the declaration.

function_heading

The function heading specifies the function name and its parameter list.

function_name

Name of the function that you are declaring or defining.

RETURN datatype

Specifies the data type of the value that the function returns, which can be any PL/SQL data type (see [PL/SQL Data Types](#)).

Restriction on datatype

You cannot constrain this data type (with `NOT NULL`, for example). If *datatype* is a constrained subtype, then the returned value does not inherit the constraints of the subtype (see "[Formal Parameters of Constrained Subtypes](#)").

function_definition

Either defines a function that was declared earlier or both declares and defines a function.

declare_section

Declares items that are local to the function, can be referenced in *body*, and cease to exist when the function completes execution.

body

Required executable part and optional exception-handling part of the function. In the executable part, at least one execution path must lead to a `RETURN` statement; otherwise, a runtime error occurs.

Examples

- [Example 8-2](#), "Declaring, Defining, and Invoking a Simple PL/SQL Function"

Related Topics

- [Formal Parameter Declaration](#)
- [Procedure Declaration and Definition](#)
- [PL/SQL Subprograms](#)

13.37 GOTO Statement

The `GOTO` statement transfers control to a labeled block or statement.

If a `GOTO` statement exits a cursor `FOR LOOP` statement prematurely, the cursor closes.

Restrictions on GOTO Statement

- A `GOTO` statement cannot transfer control into an `IF` statement, `CASE` statement, `LOOP` statement, or sub-block.
- A `GOTO` statement cannot transfer control from one `IF` statement clause to another, or from one `CASE` statement `WHEN` clause to another.
- A `GOTO` statement cannot transfer control out of a subprogram.
- A `GOTO` statement cannot transfer control into an exception handler.
- A `GOTO` statement cannot transfer control from an exception handler back into the current block (but it can transfer control from an exception handler into an enclosing block).

Topics

- [Syntax](#)
- [Semantics](#)
- [Examples](#)
- [Related Topics](#)

Syntax

goto_statement ::=

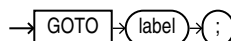

Semantics

goto_statement

label

Identifies either a block or a statement (see "*plsql_block ::=*", "*statement ::=*", and "*label*").

If *label* is not in the current block, then the GOTO statement transfers control to the first enclosing block in which *label* appears.

Examples

- [Example 4-29](#), "GOTO Statement"
- [Example 4-32](#), "GOTO Statement Transfers Control to Enclosing Block"
- [Example 4-33](#), "GOTO Statement Cannot Transfer Control into IF Statement"

Related Topics

In this chapter:

- ["Block"](#)

In other chapters:

- ["GOTO Statement"](#)

13.38 IF Statement

The IF statement either runs or skips a sequence of one or more statements, depending on the value of a BOOLEAN expression.

Topics

- [Syntax](#)
- [Semantics](#)
- [Examples](#)
- [Related Topics](#)

Syntax

if_statement ::=

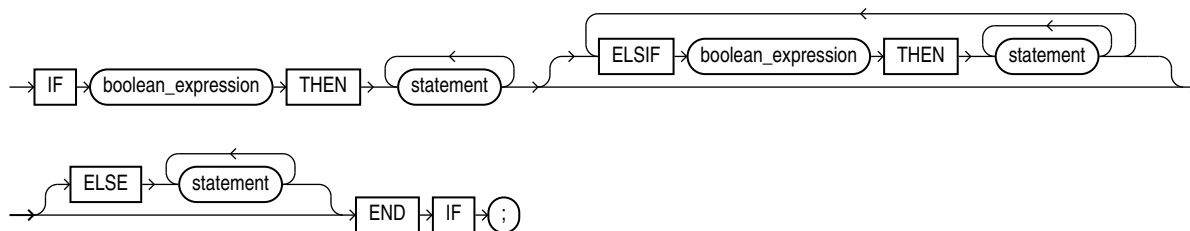

(*boolean_expression ::=* , *statement ::=*)

Semantics

boolean_expression

Expression whose value is TRUE, FALSE, or NULL.

The first *boolean_expression* is always evaluated. Each other *boolean_expression* is evaluated only if the values of the preceding expressions are `FALSE`.

If a *boolean_expression* is evaluated and its value is `TRUE`, the statements after the corresponding `THEN` run. The succeeding expressions are not evaluated, and the statements associated with them do not run.

ELSE

If no *boolean_expression* has the value `TRUE`, the statements after `ELSE` run.

Examples

- [Example 4-1](#), "IF THEN Statement"
- [Example 4-2](#), "IF THEN ELSE Statement"
- [Example 4-3](#), "Nested IF THEN ELSE Statements"
- [Example 4-4](#), "IF THEN ELSIF Statement"

Related Topics

In this chapter:

- ["CASE Statement"](#)
- ["Expression"](#)

In other chapters:

- ["Conditional Selection Statements"](#)

13.39 Implicit Cursor Attribute

An implicit cursor has attributes that return information about the most recently run `SELECT` or `DML` statement that is not associated with a named cursor.



Note:

You can use cursor attributes only in procedural statements, not in `SQL` statements.

Topics

- [Syntax](#)
- [Semantics](#)
- [Examples](#)
- [Related Topics](#)

Syntax

implicit_cursor_attribute ::=

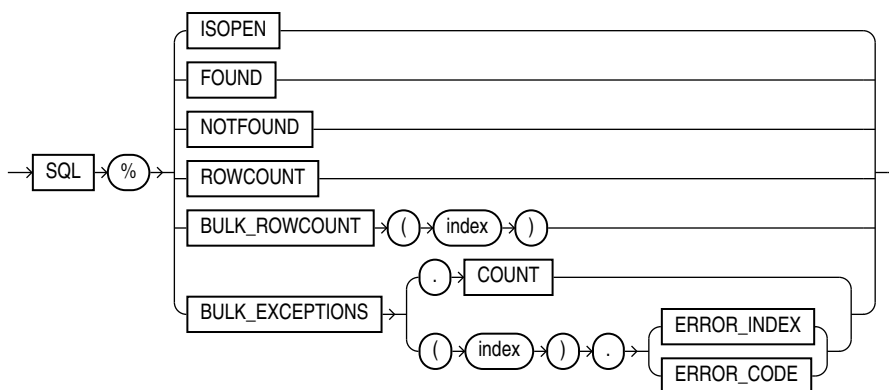

Semantics

%ISOPEN

SQL%ISOPEN always has the value FALSE.

%FOUND

SQL%FOUND has one of these values:

- If no `SELECT` or `DML` statement has run, `NULL`.
- If the most recent `SELECT` or `DML` statement returned a row, `TRUE`.
- If the most recent `SELECT` or `DML` statement did not return a row, `FALSE`.

%NOTFOUND

SQL%NOTFOUND has one of these values:

- If no `SELECT` or `DML` statement has run, `NULL`.
- If the most recent `SELECT` or `DML` statement returned a row, `FALSE`.
- If the most recent `SELECT` or `DML` statement did not return a row, `TRUE`.

%ROWCOUNT

SQL%ROWCOUNT has one of these values:

- If no `SELECT` or `DML` statement has run, `NULL`.
- If a `SELECT` or `DML` statement has run, the number of rows fetched so far.

SQL%BULK_ROWCOUNT

Composite attribute that is like an associative array whose *i*th element is the number of rows affected by the *i*th `DML` statement in the most recently completed `FORALL` statement. For more information, see "[Getting Number of Rows Affected by FORALL Statement](#)".

Restriction on SQL%BULK_ROWCOUNT

You cannot assign the value of `SQL%BULK_ROWCOUNT(index)` to another collection.

SQL%BULK_EXCEPTIONS

Composite attribute that is like an associative array of information about the DML statements that failed during the most recently run `FORALL` statement. `SQL%BULK_EXCEPTIONS.COUNT` is the number of DML statements that failed. If `SQL%BULK_EXCEPTIONS.COUNT` is not zero, then for each index value *i* from 1 through `SQL%BULK_EXCEPTIONS.COUNT`:

- `SQL%BULK_EXCEPTIONS(i).ERROR_INDEX` is the number of the DML statement that failed.
- `SQL%BULK_EXCEPTIONS(i).ERROR_CODE` is the Oracle Database error code for the failure.

Typically, this attribute appears in an exception handler for a `FORALL` statement that has a `SAVE EXCEPTIONS` clause. For more information, see "[Handling FORALL Exceptions After FORALL Statement Completes](#)".

Examples

- [Example 6-3](#), "SQL%FOUND Implicit Cursor Attribute"
- [Example 6-4](#), "SQL%ROWCOUNT Implicit Cursor Attribute"
- [Example 6-15](#), "%FOUND Explicit Cursor Attribute"
- [Example 6-14](#), "%ISOPEN Explicit Cursor Attribute"
- [Example 6-16](#), "%NOTFOUND Explicit Cursor Attribute"
- [Example 6-17](#), "%ROWCOUNT Explicit Cursor Attribute"
- [Example 12-13](#), "Handling FORALL Exceptions After FORALL Statement Completes"
- [Example 12-14](#), "Showing Number of Rows Affected by Each DELETE in FORALL"
- [Example 12-15](#), "Showing Number of Rows Affected by Each INSERT SELECT in FORALL"

Related Topics

In this chapter:

- "[FORALL Statement](#)"
- "[Named Cursor Attribute](#)"

In other chapters:

- "[Implicit Cursors](#)"
- "[Processing Query Result Sets](#)"

13.40 INLINE Pragma

The `INLINE` pragma specifies whether a subprogram invocation is to be inlined.

Inlining replaces a subprogram invocation with a copy of the invoked subprogram (if the invoked and invoking subprograms are in the same program unit).

Note:

The `INLINE` pragma affects only the immediately following declaration or statement, and only some kinds of statements. For details, see "[Subprogram Inlining](#)".

Topics

- [Syntax](#)
- [Semantics](#)
- [Examples](#)
- [Related Topics](#)

Syntax

inline_pragma ::=

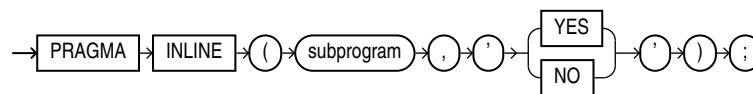
**Semantics*****subprogram***

Name of a subprogram. If *subprogram* is overloaded, then the `INLINE` pragma applies to every subprogram with that name.

YES

If `PLSQL_OPTIMIZE_LEVEL=2`, 'YES' specifies that the subprogram invocation is to be inlined.

If `PLSQL_OPTIMIZE_LEVEL=3`, 'YES' specifies that the subprogram invocation has a high priority for inlining.

NO

Specifies that the subprogram invocation is not to be inlined.

Examples

- [Example 12-1](#), "Specifying that Subprogram Is To Be Inlined"
- [Example 12-2](#), "Specifying that Overloaded Subprogram Is To Be Inlined"
- [Example 12-3](#), "Specifying that Subprogram Is Not To Be Inlined"
- [Example 12-4](#), "PRAGMA INLINE ... 'NO' Overrides PRAGMA INLINE ... 'YES'"

Related Topics

- ["Subprogram Inlining"](#)

13.41 Invoker's Rights and Definer's Rights Clause

Specifies the `AUTHID` property of a stored PL/SQL subprogram. The `AUTHID` property affects the name resolution and privilege checking of SQL statements that the unit issues at run time.

The *invoker_rights_clause* can appear in the following SQL statements :

- [ALTER TYPE Statement](#)
- [CREATE FUNCTION Statement](#)
- [CREATE PACKAGE Statement](#)
- [CREATE PROCEDURE Statement](#)
- [CREATE TYPE Statement](#)
- [CREATE TYPE BODY Statement](#)

Topics

- [Syntax](#)
- [Semantics](#)
- [Related Topics](#)

Syntax

invoker_rights_clause ::=

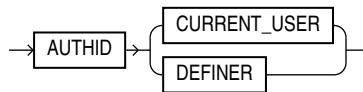

Semantics

invoker_rights_clause

When it appears in the package declaration, it specifies the `AUTHID` property of functions and procedures in the package, and of the explicit cursors declared in the package specification.

When it appears in a standalone function declaration, it specifies the `AUTHID` property of the function.

When it appears in a standalone procedure declaration, it specifies the `AUTHID` property of the procedure.

The *invoker_rights_clause* can appear only once in a subprogram declaration.

When it appears in an ADT, it specifies the `AUTHID` property of the member functions and procedures of the ADT.

Restrictions on *invoker_rights_clause*

The following restrictions apply for types:

- This clause is valid only for ADTs, not for a nested table or `VARRAY` type.
- You can specify this clause for clarity if you are creating a subtype. However, a subtype inherits the `AUTHID` property of its supertype, so you cannot specify a different value than was specified for the supertype.
- If the supertype was created with `AUTHID DEFINER`, then you must create the subtype in the same schema as the supertype.

Related Topics

In this book:

- ["Invoker's Rights and Definer's Rights \(AUTHID Property\)"](#) for information about the `AUTHID` property
- ["Subprogram Properties"](#)

13.42 INSERT Statement Extension

The PL/SQL extension to the SQL `INSERT` statement lets you specify a record name in the *values_clause* of the *single_table_insert* instead of specifying a column list in the *insert_into_clause*

Effectively, this form of the `INSERT` statement inserts the record into the table; actually, it adds a row to the table and gives each column of the row the value of the corresponding record field.



See Also:

Oracle Database SQL Language Reference for the syntax of the SQL `INSERT` statement

Topics

- [Syntax](#)
- [Semantics](#)
- [Examples](#)
- [Related Topics](#)

Syntax

insert_into_clause ::=

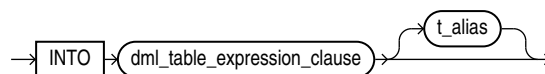

values_clause ::=



Semantics

insert_into_clause

dml_table_expression_clause

Typically a table name. For complete information, see *Oracle Database SQL Language Reference*.

t_alias

An alias for *dml_table_expression_clause*.

values_clause

record

Name of a record variable of type `RECORD` or `%ROWTYPE`. *record* must represent a row of the item explained by *dml_table_expression_clause*. That is, for every column of the row, the record must have a field with a compatible data type. If a column has a `NOT NULL` constraint, then its corresponding field cannot have a `NULL` value.

See Also:

Oracle Database SQL Language Reference for the complete syntax of the `INSERT` statement

Examples

- [Example 5-54](#), "Initializing Table by Inserting Record of Default Values"

Related Topics

In this chapter:

- ["Record Variable Declaration"](#)
- ["%ROWTYPE Attribute"](#)

In other chapters:

- ["Inserting Records into Tables"](#)
- ["Restrictions on Record Inserts and Updates"](#)

13.43 Named Cursor Attribute

Every named cursor (explicit cursor or cursor variable) has four attributes, each of which returns information about the execution of a DML statement.

Note:

You can use cursor attributes only in procedural statements, not in SQL statements.

Topics

- [Syntax](#)
- [Semantics](#)
- [Examples](#)
- [Related Topics](#)

Syntax

***named_cursor_attribute* ::=**

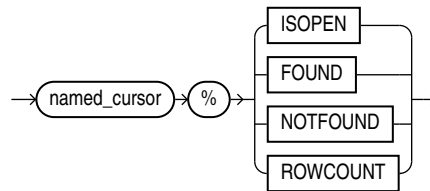

***named_cursor* ::=**

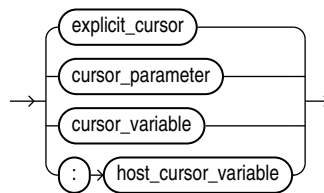

Semantics

named_cursor_attribute

%ISOPEN

named_cursor%ISOPEN has the value **TRUE** if the cursor is open, and **FALSE** if it is not open.

%FOUND

named_cursor%FOUND has one of these values:

- If the cursor is not open, **INVALID_CURSOR**
- If cursor is open but no fetch was tried, **NULL**.
- If the most recent fetch returned a row, **TRUE**.
- If the most recent fetch did not return a row, **FALSE**.

%NOTFOUND

named_cursor%NOTFOUND has one of these values:

- If cursor is not open, `INVALID_CURSOR`.
- If cursor is open but no fetch was tried, `NULL`.
- If the most recent fetch returned a row, `FALSE`.
- If the most recent fetch did not return a row, `TRUE`.

%ROWCOUNT

named_cursor%ROWCOUNT has one of these values:

- If cursor is not open, `INVALID_CURSOR`.
- If cursor is open, the number of rows fetched so far.

named_cursor

explicit_cursor

Name of an explicit cursor.

cursor_parameter

Name of a formal cursor parameter.

cursor_variable

Name of a cursor variable.

:host_cursor_variable

Name of a cursor variable that was declared in a PL/SQL host environment and passed to PL/SQL as a bind variable. Do not put space between the colon (:) and *host_cursor_variable*.

Examples

- [Example 6-14](#), "%ISOPEN Explicit Cursor Attribute"
- [Example 6-15](#), "%FOUND Explicit Cursor Attribute"
- [Example 6-16](#), "%NOTFOUND Explicit Cursor Attribute"
- [Example 6-17](#), "%ROWCOUNT Explicit Cursor Attribute"

Related Topics

In this chapter:

- ["Cursor Variable Declaration"](#)
- ["Explicit Cursor Declaration and Definition"](#)
- ["Implicit Cursor Attribute"](#)

In other chapters:

- ["Explicit Cursor Attributes"](#)

13.44 NULL Statement

The `NULL` statement is a "no-op" (no operation)—it only passes control to the next statement.



Note:

The `NULL` statement and the `BOOLEAN` value `NULL` are not related.

Topics

- [Syntax](#)
- [Examples](#)
- [Related Topics](#)

Syntax

null_statement ::=

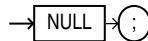

Examples

- [Example 4-31](#), "GOTO Statement Goes to Labeled NULL Statement"
- [Example 4-34](#), "NULL Statement Showing No Action"
- [Example 4-35](#), "NULL Statement as Placeholder During Subprogram Creation"

Related Topics

- ["NULL Statement"](#)

13.45 OPEN Statement

The `OPEN` statement opens an explicit cursor, allocates database resources to process the associated query, identifies the result set, and positions the cursor before the first row of the result set.

If the query has a `FOR UPDATE` clause, the `OPEN` statement locks the rows of the result set.

Topics

- [Syntax](#)
- [Semantics](#)
- [Examples](#)

- [Related Topics](#)

Syntax

open_statement ::=

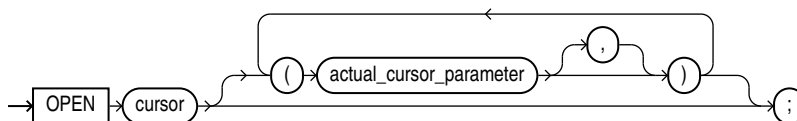

Semantics

cursor

Name of an explicit cursor that is not open.

actual_cursor_parameter

List of actual parameters for the cursor that you are opening. An actual parameter can be a constant, initialized variable, literal, or expression. The data type of each actual parameter must be compatible with the data type of the corresponding formal parameter.

You can specify actual cursor parameters with either positional notation or named notation. For information about these notations, see "[Positional, Named, and Mixed Notation for Actual Parameters](#)".

If the cursor specifies a default value for a parameter, you can omit that parameter from the parameter list. If the cursor has no parameters, or specifies a default value for every parameter, you can either omit the parameter list or specify an empty parameter list.

Examples

- [Example 6-11](#), "Explicit Cursor that Accepts Parameters"
- [Example 6-12](#), "Cursor Parameters with Default Values"

Related Topics

In this chapter:

- "[CLOSE Statement](#)"
- "[Explicit Cursor Declaration and Definition](#)"
- "[FETCH Statement](#)"
- "[OPEN FOR Statement](#)"

In other chapters:

- "[Opening and Closing Explicit Cursors](#)"
- "[Explicit Cursors that Accept Parameters](#)"

13.46 OPEN FOR Statement

The `OPEN FOR` statement associates a cursor variable with a query, allocates database resources to process the query, identifies the result set, and positions the cursor before the first row of the result set.

If the query has a `FOR UPDATE` clause, then the `OPEN FOR` statement locks the rows of the result set.

Topics

- [Syntax](#)
- [Semantics](#)
- [Examples](#)
- [Related Topics](#)

Syntax

open_for_statement ::=

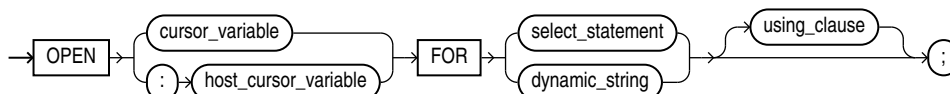

using_clause ::=

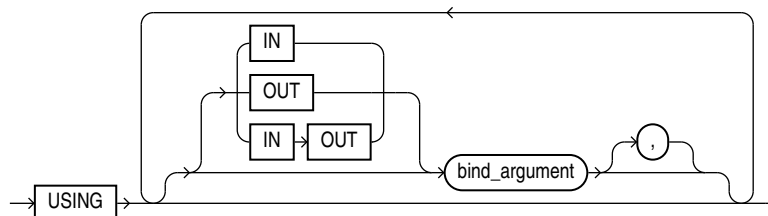

Semantics

open_for_statement

cursor_variable

Name of a cursor variable. If *cursor_variable* is the formal parameter of a subprogram, then it must not have a return type. For information about cursor variables as subprogram parameters, see "[Cursor Variables as Subprogram Parameters](#)".

:host_cursor_variable

Name of a cursor variable that was declared in a PL/SQL host environment and passed to PL/SQL as a bind variable. Do not put space between the colon (:) and *host_cursor_variable*.

The data type of a host cursor variable is compatible with the return type of any PL/SQL cursor variable.

select_statement

SQL `SELECT` statement (not a PL/SQL `SELECT INTO` statement). Typically, *select_statement* returns multiple rows.



See:

Oracle Database SQL Language Reference for `SELECT` statement syntax

dynamic_string

String literal, string variable, or string expression of the data type `CHAR`, `VARCHAR2`, or `CLOB`, which represents a SQL `SELECT` statement. Typically, *dynamic_statement* represents a SQL `SELECT` statement that returns multiple rows.

using_clause

Specifies bind variables, using positional notation.



Note:

If you repeat placeholder names in *dynamic_sql_statement*, be aware that the way placeholders are associated with bind variables depends on the kind of dynamic SQL statement. For details, see "[Repeated Placeholder Names in Dynamic SQL Statements](#)."

Restriction on *using_clause*

Use if and only if *select_statement* or *dynamic_sql_stmt* includes placeholders for bind variables.

IN, OUT, IN OUT

Parameter modes of bind variables. An `IN` bind variable passes its value to the *select_statement* or *dynamic_string*. An `OUT` bind variable stores a value that *dynamic_string* returns. An `IN OUT` bind variable passes its initial value to *dynamic_string* and stores a value that *dynamic_string* returns. **Default:** `IN`.

bind_argument

Expression whose value replaces its corresponding placeholder in *select_statement* or *dynamic_string* at run time. You must specify a *bind_argument* for every placeholder.

 **Note:**

Bind variables can be evaluated in any order. If a program determines order of evaluation, then at the point where the program does so, its behavior is undefined.

Restrictions on *bind_argument*

- *bind_argument* cannot be an associative array indexed by string.
- *bind_argument* cannot be the reserved word `NULL`.

To pass the value `NULL` to the dynamic SQL statement, use an uninitialized variable where you want to use `NULL`, as in [Example 7-7](#).

Examples

- [Example 6-26](#), "Fetching Data with Cursor Variables"
- [Example 6-30](#), "Querying a Collection with Static SQL"
- [Example 6-31](#), "Procedure to Open Cursor Variable for One Query"
- [Example 6-32](#), "Opening Cursor Variable for Chosen Query (Same Return Type)"
- [Example 6-33](#), "Opening Cursor Variable for Chosen Query (Different Return Types)"
- [Example 7-8](#), "Native Dynamic SQL with OPEN FOR, FETCH, and CLOSE Statements"
- [Example 7-9](#), "Querying a Collection with Native Dynamic SQL"

Related Topics

In this chapter:

- ["CLOSE Statement"](#)
- ["Cursor Variable Declaration"](#)
- ["EXECUTE IMMEDIATE Statement"](#)
- ["FETCH Statement"](#)
- ["OPEN Statement"](#)

In other chapters:

- ["Opening and Closing Cursor Variables"](#)
- ["OPEN FOR, FETCH, and CLOSE Statements"](#)

13.47 PARALLEL_ENABLE Clause

Enables the function for parallel execution, making it safe for use in concurrent sessions of parallel DML evaluations.

Indicates that the function can run from a parallel execution server of a parallel query operation.

The `PARALLEL_ENABLE` clause can appear in the following SQL statements:

- [CREATE FUNCTION Statement](#)
- [CREATE PACKAGE Statement](#)
- [CREATE TYPE BODY Statement](#)

Topics

- [Syntax](#)
- [Semantics](#)
- [Related Topics](#)

Syntax

parallel_enable_clause ::=

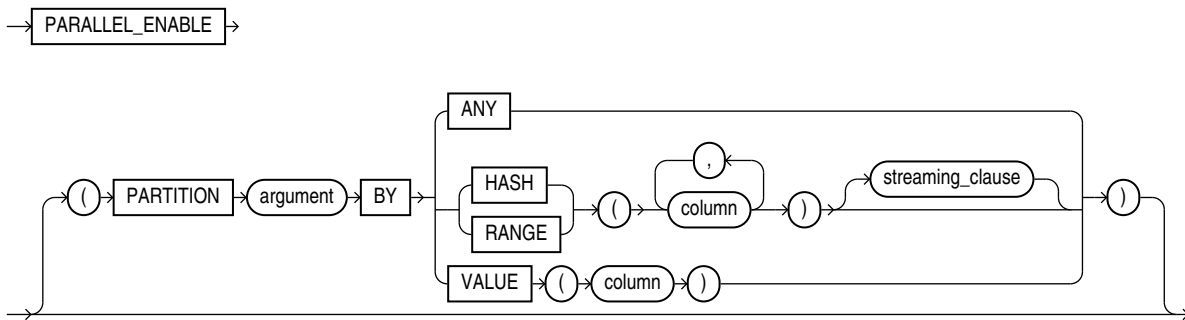

streaming_clause ::=

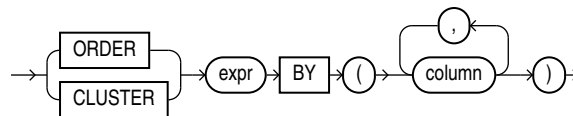

Semantics

parallel_enable_clause

The *parallel_enable_clause* can appear only once in the function.

The function must not use session state, such as package variables, because those variables are not necessarily shared among the parallel execution servers.

Use the optional `PARTITION argument BY` clause only with a function that has a `REF CURSOR` data type. This clause lets you define the partitioning of the inputs to the function from the `REF CURSOR` argument. Partitioning the inputs to the function affects the way the query is parallelized when the function is used as a table function in the `FROM` clause of the query.

ANY

Indicates that the data can be partitioned randomly among the parallel execution servers

 **Note:**

You can partition weak cursor variable arguments to table functions only with ANY, not with RANGE, HASH, or VALUE.

RANGE or HASH

Partitions data into specified columns that are returned by the REF CURSOR argument of the function.

streaming_clause

The optional *streaming_clause* lets you order or cluster the parallel processing.

ORDER BY | CLUSTER BY

ORDER BY or CLUSTER BY indicates that the rows on a parallel execution server must be locally ordered and have the same key values as specified by the *column* list.

VALUE

Specifies direct-key partitioning, which is intended for table functions used when executing MapReduce workloads. The *column* must be of data type NUMBER. VALUE distributes row processing uniformly over the available reducers.

If the column has more reducer numbers than there are available reducers, then PL/SQL uses a modulus operation to map the reducer numbers in the column into the correct range.

When calculating the number of the reducer to process the corresponding row, PL/SQL treats a negative value as zero and rounds a positive fractional value to the nearest integer.

 **See Also:**

Oracle Database Data Cartridge Developer's Guide for information about using parallel table functions

expr

expr identifies the REF CURSOR parameter name of the table function on which partitioning was specified, and on whose columns you are specifying ordering or clustering for each concurrent session in a parallel query execution.

Restriction on *parallel_enable_clause*

You cannot specify *parallel_enable_clause* for a nested function.

Related Topics

In this chapter:

- [Function Declaration and Definition](#)

In other chapters:

- [Overview of Table Functions](#)
- [Creating Pipelined Table Functions](#)

13.48 PIPE ROW Statement

The `PIPE ROW` statement, which can appear only in the body of a pipelined table function, returns a table row (but not control) to the invoker of the function.

Note:

- If a pipelined table function is part of an autonomous transaction, then it must `COMMIT` or `ROLLBACK` before each `PIPE ROW` statement, to avoid an error in the invoking subprogram.
- To improve performance, the PL/SQL runtime system delivers the piped rows to the invoker in batches.

Topics

- [Syntax](#)
- [Semantics](#)
- [Examples](#)
- [Related Topics](#)

Syntax

pipe_row_statement ::=

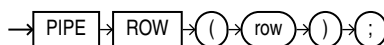

Semantics

pipe_row_statement

row

Row (table element) that the function returns to its invoker, represented by an expression whose type is that of the table element.

If the expression is a record variable, it must be explicitly declared with the data type of the table element. It cannot be declared with a data type that is only structurally identical to the element type. For example, if the element type has a name, then the record variable cannot be declared explicitly with `%TYPE` or `%ROWTYPE` or implicitly with `%ROWTYPE` in a cursor `FOR LOOP` statement.

Examples

- [Example 12-29](#), "Creating and Invoking Pipelined Table Function"
- [Example 12-30](#), "Pipelined Table Function Transforms Each Row to Two Rows"
- [Example 12-32](#), "Pipelined Table Function with Two Cursor Variable Parameters"
- [Example 12-33](#), "Pipelined Table Function as Aggregate Function"
- [Example 12-34](#), "Pipelined Table Function Does Not Handle NO_DATA_NEEDED"
- [Example 12-35](#), "Pipelined Table Function Handles NO_DATA_NEEDED"

Related Topics

In this chapter:

- ["Function Declaration and Definition"](#)

In other chapters:

- ["Creating Pipelined Table Functions"](#)

13.49 PIPELINED Clause

Instructs the database to iteratively return the results of a **table function** or **polymorphic table function**.

Use only with a table function, to specify that it is pipelined. A pipelined table function returns a row to its invoker immediately after processing that row and continues to process rows. To return a row (but not control) to the invoker, the function uses the ["PIPE ROW Statement"](#).

A table function returns a collection type.

A polymorphic table function is a table function whose return type is determined by the arguments.

You query both kinds of table functions by using the `TABLE` keyword before the function name in the `FROM` clause of the query. For example:

```
SELECT * FROM TABLE(function_name(...))
```

The `TABLE` operator is optional when the table function arguments list or empty list `()` appears. For example:

```
SELECT * FROM function_name()
```

the database then returns rows as they are produced by the function.

The `PIPELINED` option can appear in the following SQL statements:

- [CREATE FUNCTION Statement](#)
- [CREATE PACKAGE Statement](#)
- [CREATE PACKAGE BODY Statement](#)

Topics

- [Syntax](#)
- [Semantics](#)
- [Examples](#)
- [Related Topics](#)

Syntax

pipelined_clause ::=

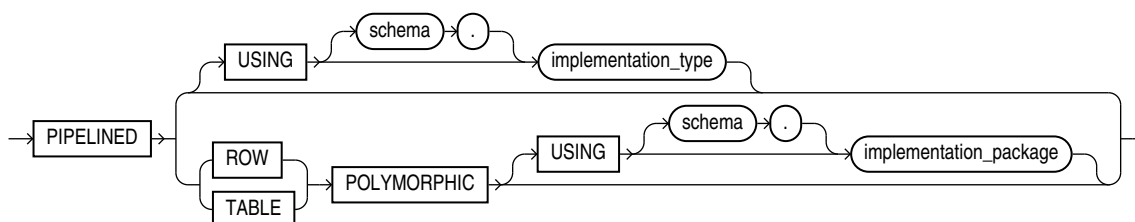

Semantics

pipelined_clause

The *pipelined_clause* can appear only once in the function.

PIPELINED

To make a pipelined function, include the *pipelined_clause* in the function definition. If you declare the pipelined function before defining it, you must specify the `PIPELINED` option in the function declaration.

{ IS | USING }

- If you specify the keyword `PIPELINED` alone (`PIPELINED IS ...`), then the PL/SQL function body must use the `PIPE` keyword. This keyword instructs the database to return single elements of the collection out of the function, instead of returning the whole collection as a single value.
- You can specify the `PIPELINED USING implementation_type` clause to predefine an interface containing the start, fetch, and close operations. The implementation type must implement the `ODCItable` interface and must exist at the time the table function is created. This clause is useful for table functions implemented in external languages such as C++ and Java.

If the return type of the function is `ANYDATASET`, then you must also define a describe method (`ODCItableDescribe`) as part of the implementation type of the function.

[schema.] implementation_type

The implementation type must be an ADT containing the implementation of the `ODCIAggregate` subprograms. If you do not specify *schema*, then the database assumes that the implementation type is in your schema.

Restriction on PIPELINED

You cannot specify `PIPELINED` for a nested function.

 **Note:**

You cannot run a pipelined table function over a database link. The reason is that the return type of a pipelined table function is a SQL user-defined type, which can be used only in a single database (as explained in *Oracle Database Object-Relational Developer's Guide*). Although the return type of a pipelined table function might appear to be a PL/SQL type, the database actually converts that PL/SQL type to a corresponding SQL user-defined type.

`PIPELINED [ROW | TABLE] POLYMORPHIC [USING [schema.] implementation_package]`

The polymorphic table function elaborator can appear in standalone function declaration or package function declaration.

PIPELINED

Required when defining a polymorphic table function.

ROW

Specify `ROW` when a single input argument of type `TABLE` determines new columns using any single row.

TABLE

Specify `TABLE` when a single input argument of type `TABLE` determines the new columns using the current row and operates on an entire table or a logical partition of a table.

POLYMORPHIC

Restrictions on `POLYMORPHIC`

The following are not allowed for `POLYMORPHIC` table functions:

- `PARALLEL_ENABLE` clause
- `RESULT_CACHE` clause
- `DETERMINISTIC` option
- `AUTHID` property (Invoker's Rights and Definer's Rights Clause)

`[USING [schema.] implementation_package]`

References the polymorphic table function (PTF) implementation package. The specification must include `DESCRIBE` method. The specification of `OPEN`, `FETCH_ROWS` and `CLOSE` methods is optional. The specification for the implementation package must already exist (unless the PTF and its implementation reside in the same package).

If a polymorphic table function and its implementation methods are defined in the same package, then the `USING` clause is optional.

Examples

- [Examples](#) for PIPE ROW statement examples
- [Skip_col Polymorphic Table Function Example](#)
- [To_doc Polymorphic Table Function Example](#)
- [Implicit_echo Polymorphic Table Function Example](#)
- *Oracle Database PL/SQL Packages and Types Reference* for more examples using the DBMS_TF package utilities

Related Topics

In this chapter:

- ["Function Declaration and Definition"](#)

In other chapters:

- ["Overview of Table Functions"](#)
- ["Overview of Polymorphic Table Functions"](#) for more information about PTFs
- ["Subprogram Parts"](#)
- ["Creating Pipelined Table Functions"](#)
- ["Chaining Pipelined Table Functions for Multiple Transformations"](#)

In other books:

- *Oracle Database PL/SQL Packages and Types Reference* for more information about the DBMS_TF package containing utilities for Polymorphic Table Functions (PTF) implementation
- *Oracle Database Data Cartridge Developer's Guide* for information about using pipelined table functions

13.50 Procedure Declaration and Definition

Before invoking a procedure, you must declare and define it. You can either declare it first (with ***procedure_declaration***) and then define it later in the same block, subprogram, or package (with ***procedure_definition***) or declare and define it at the same time (with ***procedure_definition***).

A **procedure** is a subprogram that performs a specific action. A procedure invocation (or call) is a statement.

A procedure declaration is also called a **procedure specification** or **procedure spec**.



Note:

For more information about standalone procedures, see "[CREATE PROCEDURE Statement](#)". For more information about package procedures, see "[CREATE PACKAGE Statement](#)".

Topics

- [Syntax](#)
- [Semantics](#)
- [Examples](#)
- [Related Topics](#)

Syntax

procedure_declaration ::=

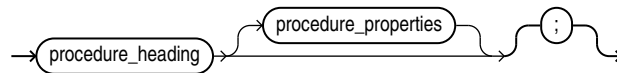

([procedure_properties ::=](#))

procedure_heading ::=

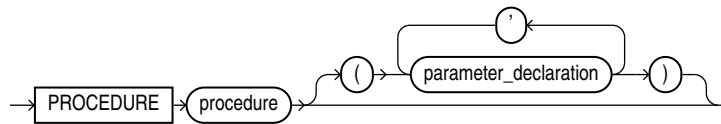

See "[parameter_declaration ::=](#)".

procedure_properties ::=

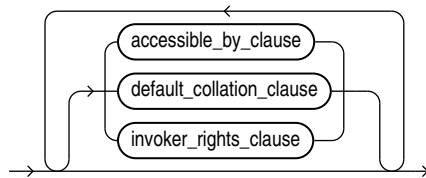

([accessible_by_clause ::=](#) , [default_collation_clause ::=](#) , [invoker_rights_clause ::=](#))

procedure_definition ::=

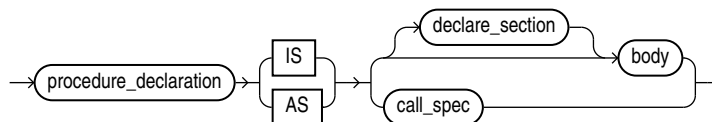

([body ::=](#) , [declare_section ::=](#) , [call_spec ::=](#))

Semantics

procedure_declaration

Declares a procedure, but does not define it. The definition must appear later in the same block, subprogram, or package as the declaration.

procedure_heading

procedure

Name of the procedure that you are declaring or defining.

procedure_properties

Each procedure property can appear only once in the procedure declaration. The properties can appear in any order. Properties appear before the `IS` or `AS` keyword in the heading. The properties cannot appear in nested procedures. Only the `ACCESSIBLE BY` property can appear in package procedures.

Standalone procedures may have the following properties in their declaration.

- [ACCESSIBLE BY Clause](#)
- [DEFAULT COLLATION Clause](#)
- [Invoker's Rights and Definer's Rights \(AUTHID Property\)](#)

procedure_definition

Either defines a procedure that was declared earlier or both declares and defines a procedure.

declare_section

Declares items that are local to the procedure, can be referenced in *body*, and cease to exist when the procedure completes execution.

body

Required executable part and optional exception-handling part of the procedure.

Examples

- [Example 8-1](#), "Declaring, Defining, and Invoking a Simple PL/SQL Procedure"

Related Topics

In this chapter:

- ["Formal Parameter Declaration"](#)
- ["Function Declaration and Definition"](#)

In other chapters:

- ["PL/SQL Subprograms"](#)
- ["CREATE PROCEDURE Statement"](#)

13.51 RAISE Statement

The `RAISE` statement explicitly raises an exception.

Outside an exception handler, you must specify the exception name. Inside an exception handler, if you omit the exception name, the `RAISE` statement reraises the current exception.

Topics

- [Syntax](#)
- [Semantics](#)
- [Examples](#)
- [Related Topics](#)

Syntax

raise_statement ::=

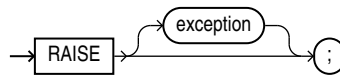

Semantics

exception

Name of an exception, either predefined (see [Table 11-3](#)) or user-declared (see ["Exception Declaration"](#)).

exception is optional only in an exception handler, where the default is the current exception (see ["Reraising Current Exception with RAISE Statement"](#)).

Examples

- [Example 11-10](#), "Declaring, Raising, and Handling User-Defined Exception"
- [Example 11-11](#), "Explicitly Raising Predefined Exception"
- [Example 11-12](#), "Reraising Exception"

Related Topics

In this chapter:

- ["Exception Declaration"](#)
- ["Exception Handler"](#)

In other chapters:

- ["Raising Exceptions Explicitly"](#)

13.52 Record Variable Declaration

A **record variable** is a composite variable whose internal components, called fields, can have different data types. The value of a record variable and the values of its fields can change.

You reference an entire record variable by its name. You reference a record field with the syntax *record.field*.

You can create a record variable in any of these ways:

- Define a record type and then declare a variable of that type.
- Use `%ROWTYPE` to declare a record variable that represents either a full or partial row of a database table or view.
- Use `%TYPE` to declare a record variable of the same type as a previously declared record variable.

Topics

- [Syntax](#)
- [Semantics](#)
- [Examples](#)
- [Related Topics](#)

Syntax

record_type_definition ::=



field_definition ::=

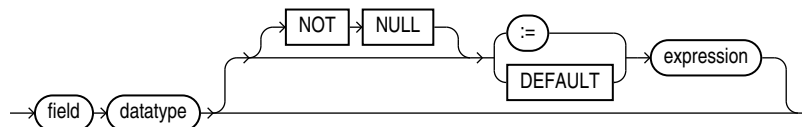

(*datatype ::=* , *expression ::=*)

record_variable_declaration ::=

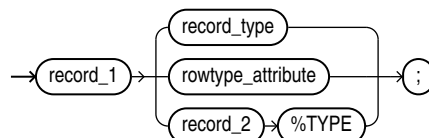

(*rowtype_attribute* ::=)

Semantics

record_type_definition

record_type

Name of the record type that you are defining.

field_definition

field

Name of the field that you are defining.

datatype

Data type of the field that you are defining.

NOT NULL

Imposes the NOT NULL constraint on the field that you are defining.

For information about this constraint, see "[NOT NULL Constraint](#)".

expression

Expression whose data type is compatible with *datatype*. When *record_variable_declaration* is elaborated, the value of *expression* is assigned to *record.field*. This value is the initial value of the field.

record_variable_declaration

record_1

Name of the record variable that you are declaring.

record_type

Name of a previously defined record type. *record_type* is the data type of *record_1*.

rowtype_attribute

See "[%ROWTYPE Attribute](#)".

record_2

Name of a previously declared record variable.

%TYPE

See "[%TYPE Attribute](#)".

Examples

- [Example 5-36](#), "RECORD Type Definition and Variable Declaration"
- [Example 5-37](#), "RECORD Type with RECORD Field (Nested Record)"
- [Example 5-38](#), "RECORD Type with Varray Field"

Related Topics

In this chapter:

- ["Collection Variable Declaration"](#)
- ["%ROWTYPE Attribute"](#)

In other chapters:

- ["Record Topics"](#)

13.53 RESTRICT_REFERENCES Pragma

The `RESTRICT_REFERENCES` pragma asserts that a user-defined subprogram does not read or write database tables or package variables.



Note:

The `RESTRICT_REFERENCES` pragma is deprecated. Oracle recommends using `DETERMINISTIC` and `PARALLEL_ENABLE` instead of `RESTRICT_REFERENCES`.

Subprograms that read or write database tables or package variables are difficult to optimize, because any invocation of the subprogram might produce different results or encounter errors. If a statement in a user-defined subprogram violates an assertion made by `RESTRICT_REFERENCES`, then the PL/SQL compiler issues an error message when it parses that statement, unless you specify `TRUST`.

Typically, this pragma is specified for functions. If a function invokes procedures, then specify this pragma for those procedures also.

Restrictions on RESTRICT_REFERENCES Pragma

- This pragma can appear only in a package specification or ADT specification.
- Only one `RESTRICT_REFERENCES` pragma can reference a given subprogram.

Topics

- [Syntax](#)
- [Semantics](#)

Syntax

restrict_references_pragma ::=

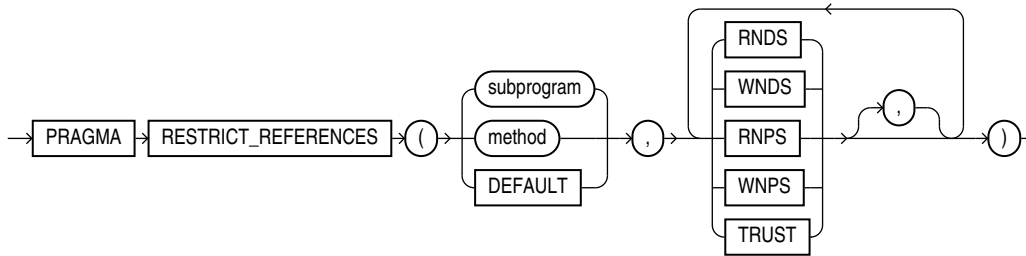

Semantics

subprogram

Name of a user-defined subprogram, typically a function. If *subprogram* is overloaded, the pragma applies only to the most recent subprogram declaration.

method

Name of a `MEMBER` subprogram. See "[CREATE TYPE Statement](#)" for more information.

DEFAULT

Applies the pragma to all subprograms in the package specification or ADT specification (including the system-defined constructor for ADTs).

If you also declare the pragma for an individual subprogram, it overrides the `DEFAULT` pragma for that subprogram.

RNDS

Asserts that the subprogram reads no database state (does not query database tables).

WNDS

Asserts that the subprogram writes no database state (does not modify tables).

RNPS

Asserts that the subprogram reads no package state (does not reference the values of package variables)

Restriction on RNPS

You cannot specify `RNPS` if the subprogram invokes the `SQLCODE` or `SQLERRM` function.

WNPS

Asserts that the subprogram writes no package state (does not change the values of package variables).

Restriction on WNPS

You cannot specify `WNPS` if the subprogram invokes the `SQLCODE` or `SQLERRM` function.

TRUST

Asserts that the subprogram can be trusted not to violate the other specified assertions and prevents the PL/SQL compiler from checking the subprogram body for violations. Skipping these checks can improve performance.

If your PL/SQL subprogram invokes a C or Java subprogram, then you must specify `TRUST` for either the PL/SQL subprogram or the C or Java subprogram, because the PL/SQL compiler cannot check a C or Java subprogram for violations at run time.

Note:

To invoke a subprogram from a parallelized DML statement, you must specify all four constraints—`RNDS`, `WNDS`, `RNPS`, and `WNPS`. No constraint implies another.

See Also:

Oracle Database Development Guide for information about using `PRAGMA RESTRICT_REFERENCES` in existing applications

13.54 RETURN Statement

The `RETURN` statement immediately ends the execution of the subprogram or anonymous block that contains it.

In a function, the `RETURN` statement assigns a specified value to the function identifier and returns control to the invoker, where execution resumes immediately after the invocation (possibly inside the invoking statement). Every execution path in a function must lead to a `RETURN` statement (otherwise, the PL/SQL compiler issues compile-time warning PLW-05005).

In a procedure, the `RETURN` statement returns control to the invoker, where execution resumes immediately after the invocation.

In an anonymous block, the `RETURN` statement exits its own block and all enclosing blocks.

A subprogram or anonymous block can contain multiple `RETURN` statements.

Note:

The `RETURN` statement differs from the `RETURN` clause in a function heading, which specifies the data type of the return value.

Topics

- [Syntax](#)
- [Semantics](#)
- [Examples](#)

- [Related Topics](#)

Syntax

return_statement ::=

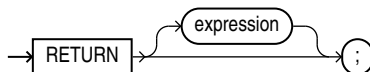

(*expression ::=*)

Semantics

expression

Optional when the `RETURN` statement is in a pipelined table function. Required when the `RETURN` statement is in any other function. Not allowed when the `RETURN` statement is in a procedure or anonymous block.

The `RETURN` statement assigns the value of *expression* to the function identifier. Therefore, the data type of *expression* must be compatible with the data type in the `RETURN` clause of the function. For information about expressions, see "[Expression](#)".

Examples

- [Example 8-3](#), "Execution Resumes After `RETURN` Statement in Function"
- [Example 8-4](#), "Function Where Not Every Execution Path Leads to `RETURN` Statement"
- [Example 8-5](#), "Function Where Every Execution Path Leads to `RETURN` Statement"
- [Example 8-6](#), "Execution Resumes After `RETURN` Statement in Procedure"
- [Example 8-7](#), "Execution Resumes After `RETURN` Statement in Anonymous Block"

Related Topics

In this chapter:

- ["Block"](#)
- ["Function Declaration and Definition"](#)
- ["Procedure Declaration and Definition"](#)

In other chapters:

- ["RETURN Statement"](#)

13.55 RETURNING INTO Clause

The `RETURNING INTO` clause specifies the variables in which to store the values returned by the statement to which the clause belongs.

The variables can be either individual variables or collections. If the statement affects no rows, then the values of the variables are undefined.

The **static** RETURNING INTO clause belongs to a DELETE, INSERT, or UPDATE statement. The **dynamic** RETURNING INTO clause belongs to the EXECUTE IMMEDIATE statement.



Note:

You cannot use the RETURNING INTO clause for remote or parallel deletes.

Topics

- [Syntax](#)
- [Semantics](#)
- [Examples](#)
- [Related Topics](#)

Syntax

static_returning_clause ::=

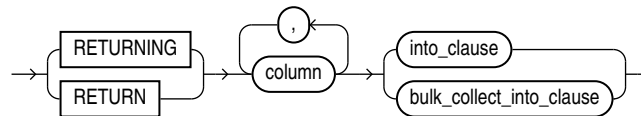

dynamic_returning_clause ::=

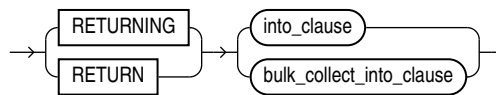

into_clause ::=

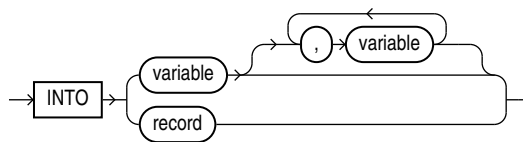

bulk_collect_into_clause ::=

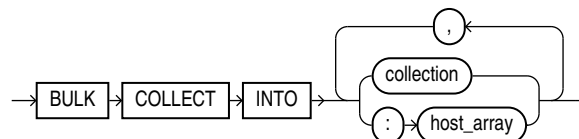

Semantics

static_returning_clause

column

Expression whose value is the name of a column of a database table.

into_clause

Specifies the variables or record in which to store the column values that the statement returns.

Restriction on *into_clause*

Use *into_clause* in *dynamic_returning_clause* if and only if *dynamic_sql_stmt* (which appears in "EXECUTE IMMEDIATE Statement") returns a single row.

record

The name of a record variable in which to store the row that the statement returns. For each *select_list* item in the statement, the record must have a corresponding, type-compatible field.

variable

Either the name of a scalar variable in which to store a column that the statement returns or the name of a host cursor variable that is declared in a PL/SQL host environment and passed to PL/SQL as a bind variable. Each *select_list* item in the statement must have a corresponding, type-compatible variable. The data type of a host cursor variable is compatible with the return type of any PL/SQL cursor variable.

Restriction on *variable*

variable cannot have the data type `BOOLEAN`.

bulk_collect_into_clause

Specifies one or more existing collections or host arrays in which to store the rows that the statement returns. For each *select_list* item in the statement, *bulk_collect_into_clause* must have a corresponding, type-compatible *collection* or *host_array*.

For the reason to use this clause, see "Bulk SQL and Bulk Binding".

Restrictions on *bulk_collect_into_clause*

- Use the *bulk_collect_into_clause* clause in *dynamic_returning_clause* if and only if *dynamic_sql_stmt* (which appears in "EXECUTE IMMEDIATE Statement") can return multiple rows.
- You cannot use *bulk_collect_into_clause* in client programs.
- When the statement that includes *bulk_collect_into_clause* requires implicit data type conversions, *bulk_collect_into_clause* can have only one *collection* or *host_array*.

collection

Name of a collection variable in which to store the rows that the statement returns.

Restrictions on *collection*

- *collection* cannot be the name of an associative array that is indexed by a string.
- When the statement requires implicit data type conversions, *collection* cannot be the name of a collection of a composite type.

:*host_array*

Name of an array declared in a PL/SQL host environment and passed to PL/SQL as a bind variable. Do not put space between the colon (:) and *host_array*.

Examples

- [Example 5-52](#), "UPDATE Statement Assigns Values to Record Variable"
- [Example 6-1](#), "Static SQL Statements"
- [Example 12-25](#), "Returning Deleted Rows in Two Nested Tables"
- [Example 12-26](#), "DELETE with RETURN BULK COLLECT INTO in FORALL Statement"

Related Topics

In this chapter:

- ["DELETE Statement Extension"](#)
- ["EXECUTE IMMEDIATE Statement"](#)
- ["FETCH Statement"](#)
- ["SELECT INTO Statement"](#)
- ["UPDATE Statement Extensions"](#)

In other chapters:

- ["Using SQL Statements to Return Rows in PL/SQL Record Variables"](#)
- ["EXECUTE IMMEDIATE Statement"](#)
- ["RETURNING INTO Clause with BULK COLLECT Clause"](#)

13.56 RESULT_CACHE Clause

Indicates to store the function results into the server result cache.

The `RESULT_CACHE` clause can appear in the following SQL statements:

- [CREATE FUNCTION Statement](#)
- [CREATE TYPE BODY Statement](#)

Topics

- [Syntax](#)
- [Semantics](#)
- [Examples](#)
- [Related Topics](#)

Syntax

result_cache_clause ::=

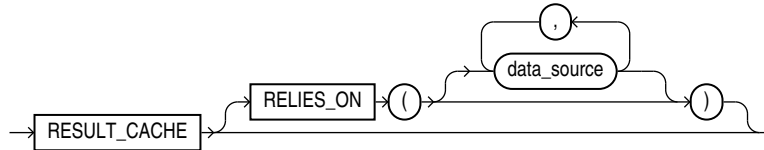

Semantics

result_cache_clause

result_cache_clause can appear only once in the function.

RESULT_CACHE

To make a function result-cached, include the RESULT_CACHE clause in the function definition. If you declare the function before defining it, you must also include the RESULT_CACHE option in the function declaration.

Restriction on RESULT_CACHE

- RESULT_CACHE is disallowed on functions with OUT or IN OUT parameters.
- RESULT_CACHE is disallowed on functions with IN or RETURN parameter of (or containing) these types:
 - BLOB
 - CLOB
 - NCLOB
 - REF CURSOR
 - Collection
 - Object
 - Record or PL/SQL collection that contains an unsupported return type
- RESULT_CACHE is disallowed on function in an anonymous block.
- RESULT_CACHE is disallowed on pipelined table function and nested function.

RELIES_ON

Specifies the data sources on which the results of the function depend. Each *data_source* is the name of either a database table or view.

 **Note:**

- This clause is deprecated. As of Oracle Database 12c, the database detects all data sources that are queried while a result-cached function is running, and `RELIES_ON` clause does nothing.
- You cannot use `RELIES_ON` clause in a function declared in an anonymous block.

Examples

- [Examples of Result-Cached Functions](#)

Related Topics

In this chapter:

- [Function Declaration and Definition](#)

In other chapters:

- [PL/SQL Function Result Cache](#)

In other books:

- *Oracle Database Performance Tuning Guide*

13.57 %ROWTYPE Attribute

The `%ROWTYPE` attribute lets you declare a record that represents either a full or partial row of a database table or view.

For every visible column of the full or partial row, the record has a field with the same name and data type. If the structure of the row changes, then the structure of the record changes accordingly. Making an invisible column visible changes the structure of some records declared with the `%ROWTYPE` attribute.

The record fields do not inherit the constraints or initial values of the corresponding columns.

The `%ROWTYPE` attribute cannot be used if the referenced character column has a collation other than `USING_NLS_COMP`.

Topics

- [Syntax](#)
- [Semantics](#)
- [Examples](#)
- [Related Topics](#)

Syntax

***rowtype_attribute* ::=**

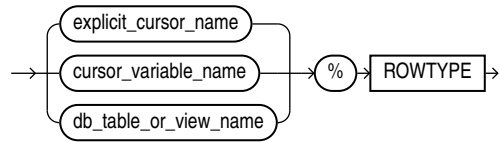

Semantics

rowtype_attribute

explicit_cursor_name

Name of an explicit cursor. For every column selected by the query associated with *explicit_cursor_name*, the record has a field with the same name and data type.

cursor_variable_name

Name of a strong cursor variable. For every column selected by the query associated with *cursor_variable_name*, the record has a field with the same name and data type.

db_table_or_view_name

Name of a database table or view that is accessible when the declaration is elaborated. For every column of *db_table_or_view_name*, the record has a field with the same name and data type.

Examples

- [Example 5-40](#), "%ROWTYPE Variable Represents Full Database Table Row"
- [Example 5-41](#), "%ROWTYPE Variable Does Not Inherit Initial Values or Constraints"
- [Example 5-42](#), "%ROWTYPE Variable Represents Partial Database Table Row"
- [Example 5-43](#), "%ROWTYPE Variable Represents Join Row"
- [Example 5-46](#), "%ROWTYPE Affected by Making Invisible Column Visible"
- [Example 5-48](#), "Assigning %ROWTYPE Record to RECORD Type Record"

Related Topics

In this chapter:

- ["Cursor Variable Declaration"](#)
- ["Explicit Cursor Declaration and Definition"](#)
- ["Record Variable Declaration"](#)
- ["%TYPE Attribute"](#)

In other chapters:

- [About Data-Bound Collation](#)

- ["Declaring Items using the %ROWTYPE Attribute"](#)
- ["%ROWTYPE Attribute and Invisible Columns"](#)

13.58 Scalar Variable Declaration

A scalar variable stores a value with no internal components. The value can change. A scalar variable declaration specifies the name and data type of the variable and allocates storage for it.

The declaration can also assign an initial value and impose the `NOT NULL` constraint.

You reference a scalar variable by its name.

Topics

- [Syntax](#)
- [Semantics](#)
- [Examples](#)
- [Related Topics](#)

Syntax

variable_declaration ::=

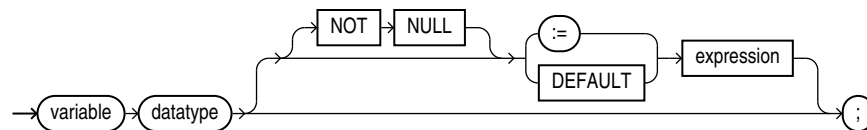

(*expression ::=*)

Semantics

variable_declaration

variable

Name of the variable that you are declaring.

datatype

Name of a scalar data type, including any qualifiers for size, precision, and character or byte semantics.

For information about scalar data types, see ["PL/SQL Data Types"](#).

NOT NULL

Imposes the `NOT NULL` constraint on the variable. For information about this constraint, see ["NOT NULL Constraint"](#).

expression

Value to be assigned to the variable when the declaration is elaborated. *expression* and *variable* must have compatible data types.

Examples

- [Example 2-11](#), "Scalar Variable Declarations"
- [Example 2-13](#), "Variable and Constant Declarations with Initial Values"
- [Example 2-14](#), "Variable Initialized to NULL by Default"
- [Example 2-9](#), "Variable Declaration with NOT NULL Constraint"

Related Topics

In this chapter:

- ["Assignment Statement"](#)
- ["Collection Variable Declaration"](#)
- ["Constant Declaration"](#)
- ["Expression"](#)
- ["Record Variable Declaration"](#)
- ["%ROWTYPE Attribute"](#)
- ["%TYPE Attribute"](#)

In other chapters:

- ["Declaring Variables"](#)
- ["PL/SQL Data Types"](#)

13.59 SELECT INTO Statement

The `SELECT INTO` statement retrieves values from one or more database tables (as the SQL `SELECT` statement does) and stores them in variables (which the SQL `SELECT` statement does not do).

Caution:

The `SELECT INTO` statement with the `BULK COLLECT` clause is vulnerable to aliasing, which can cause unexpected results. For details, see "[SELECT BULK COLLECT INTO Statements and Aliasing](#)".

See Also:

Oracle Database SQL Language Reference for the syntax of the SQL `SELECT` statement

Topics

- [Syntax](#)

- [Semantics](#)
- [Examples](#)
- [Related Topics](#)

Syntax

select_into_statement ::=

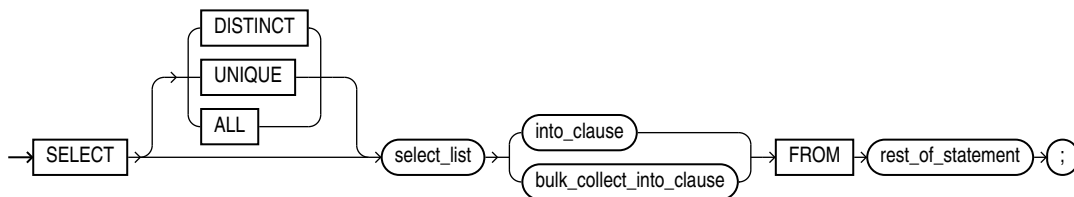

([bulk_collect_into_clause ::=](#), [into_clause ::=](#), *Oracle Database SQL Language Reference* for *select_list* syntax)

Semantics

select_into_statement

DISTINCT | UNIQUE

Specify `DISTINCT` or `UNIQUE` if you want the database to return only one copy of each set of duplicate rows selected. These two keywords are synonymous. Duplicate rows are those with matching values for each expression in the select list.

Restrictions on DISTINCT and UNIQUE Queries

- The total number of bytes in all select list expressions is limited to the size of a data block minus some overhead. This size is specified by the initialization parameter `DB_BLOCK_SIZE`.
- You cannot specify `DISTINCT` if the *select_list* contains LOB columns.

ALL

(Default) Causes the database to return all rows selected, including all copies of duplicates.

select_list

If the `SELECT INTO` statement returns no rows, PL/SQL raises the predefined exception `NO_DATA_FOUND`. To guard against this exception, select the result of the aggregate function `COUNT (*)`, which returns a single value even if no rows match the condition.

into_clause

With this clause, the `SELECT INTO` statement retrieves one or more columns from a single row and stores them in either one or more scalar variables or one record variable. For more information, see "[into_clause ::=](#)".

bulk_collect_into_clause

With this clause, the `SELECT INTO` statement retrieves an entire result set and stores it in one or more collection variables. For more information, see "[bulk_collect_into_clause ::=](#)".

rest_of_statement

Anything that can follow the keyword `FROM` in a SQL `SELECT` statement, described in *Oracle Database SQL Language Reference*.

Examples

- [Example 2-25](#), "Assigning Value to Variable with SELECT INTO Statement"
- [Example 5-50](#), "SELECT INTO Assigns Values to Record Variable"
- [Example 6-37](#), "ROLLBACK Statement"
- [Example 6-38](#), "SAVEPOINT and ROLLBACK Statements"
- [Example 6-43](#), "Declaring Autonomous Function in Package"
- [Example 7-20](#), "Validation Checks Guarding Against SQL Injection"
- [Example 12-16](#), "Bulk-Selecting Two Database Columns into Two Nested Tables"
- [Example 12-17](#), "Bulk-Selecting into Nested Table of Records"
- [Example 12-21](#), "Limiting Bulk Selection with ROWNUM, SAMPLE, and FETCH FIRST"

Related Topics

In this chapter:

- ["Assignment Statement"](#)
- ["FETCH Statement"](#)
- ["%ROWTYPE Attribute"](#)

In other chapters:

- ["Assigning Values to Variables with the SELECT INTO Statement"](#)
- ["Using SELECT INTO to Assign a Row to a Record Variable"](#)
- ["Processing Query Result Sets With SELECT INTO Statements"](#)
- ["SELECT INTO Statement with BULK COLLECT Clause"](#)



See Also:

Oracle Database SQL Language Reference for information about the SQL `SELECT` statement

13.60 SERIALLY_REUSABLE Pragma

The `SERIALLY_REUSABLE` pragma specifies that the package state is needed for only one call to the server (for example, an OCI call to the database or a stored procedure invocation through a database link).

After this call, the storage for the package variables can be reused, reducing the memory overhead for long-running sessions.

This pragma is appropriate for packages that declare large temporary work areas that are used once in the same session.

The `SERIALLY_REUSABLE` pragma can appear in the *declare_section* of the specification of a bodiless package, or in both the specification and body of a package, but not in only the body of a package.

Topics

- [Syntax](#)
- [Examples](#)
- [Related Topics](#)

Syntax

serially_reusable_pragma ::=



Examples

- [Example 10-4](#), "Creating SERIALLY_REUSABLE Packages"
- [Example 10-5](#), "Effect of SERIALLY_REUSABLE Pragma"
- [Example 10-6](#), "Cursor in SERIALLY_REUSABLE Package Open at Call Boundary"

Related Topics

- ["SERIALLY_REUSABLE Packages"](#)
- ["Pragmas"](#)

13.61 SHARING Clause

This clause applies only when creating an object in an application root. This type of object is called an application common object and it can be shared with the application PDBs that belong to the application root. The `SHARING` clause may only appear in the declarations of libraries, standalone object types, packages, and standalone subprograms in this context.

The `SHARING` clause can only appear in the context of creating an application common object with the following SQL statements:

- [CREATE FUNCTION Statement](#)

- [CREATE LIBRARY Statement](#)
- [CREATE PROCEDURE Statement](#)
- [CREATE PACKAGE Statement](#)
- [CREATE TRIGGER Statement](#)
- [CREATE TYPE Statement](#)

Topics

- [Syntax](#)
- [Semantics](#)
- [Related Topics](#)

Syntax

sharing_clause ::=

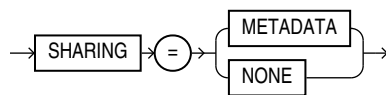

Semantics

sharing_clause

Specifies how the object is shared using one of the following sharing attributes:

- **METADATA** - A metadata link shares the metadata, but its data is unique to each container. This type of object is referred to as a **metadata-linked application common object**.
- **NONE** - The object is not shared.

If you omit this clause during an application operation, then the database uses the value of the `DEFAULT_SHARING` initialization parameter to determine the sharing attribute of the object. If the `DEFAULT_SHARING` initialization parameter does not have a value, then the default is `METADATA`.

Restrictions on `SHARING clause`

The sharing clause may only appear during an application installation, upgrade or patch in an application root. You must issue an `ALTER PLUGGABLE DATABASE APPLICATION ... BEGIN` statement to start the operation and an `ALTER PLUGGABLE DATABASE APPLICATION ... END` statement to end the operation. The *sharing_clause* is illegal outside this context and this implies the object is not shared.

You cannot change the sharing attribute of an object after it is created.

Related Topics

In other books:

- *Oracle Database Concepts* for more information about application maintenance

- *Oracle Database Concepts* for an example of patching an application using the automated technique
- *Oracle Database Reference* for more information on the `DEFAULT_SHARING` initialization parameter
- *Oracle Database Administrator's Guide* for complete information on creating application common objects

13.62 SQLCODE Function

In an exception handler, the `SQLCODE` function returns the numeric code of the exception being handled. (Outside an exception handler, `SQLCODE` returns 0.)

For an internally defined exception, the numeric code is the number of the associated Oracle Database error. This number is negative except for the error "no data found", whose numeric code is +100.

For a user-defined exception, the numeric code is either +1 (**default**) or the error code associated with the exception by the `EXCEPTION_INIT` pragma.

A SQL statement cannot invoke `SQLCODE`.

If a function invokes `SQLCODE`, and you use the `RESTRICT_REFERENCES` pragma to assert the purity of the function, then you cannot specify the constraints `WNPS` and `RNPS`.

Topics

- [Syntax](#)
- [Examples](#)
- [Related Topics](#)

Syntax

`sqlcode_function ::=`

→ SQLCODE →

Examples

- [Example 11-23](#), "Displaying SQLCODE and SQLERRM Values"

Related Topics

In this chapter:

- ["Block"](#)
- ["EXCEPTION_INIT Pragma"](#)
- ["Exception Handler"](#)
- ["RESTRICT_REFERENCES Pragma"](#)
- ["SQLERRM Function"](#)

In other chapters:

- ["Retrieving Error Code and Error Message"](#)

 **See Also:**

Oracle Database Error Messages Reference for a list of Oracle Database error messages and information about them, including their numbers

13.63 SQLERRM Function

The `SQLERRM` function returns the error message associated with an error code.

 **Note:**

The language of the error message depends on the `NLS_LANGUAGE` parameter. For information about this parameter, see *Oracle Database Globalization Support Guide*.

A SQL statement cannot invoke `SQLERRM`.

If a function invokes `SQLERRM`, and you use the `RESTRICT_REFERENCES` pragma to assert the purity of the function, then you cannot specify the constraints `WNPS` and `RNPS`.

 **Note:**

`DBMS_UTILITY.FORMAT_ERROR_STACK` is recommended over `SQLERRM`, unless you use the `FORALL` statement with its `SAVE EXCEPTIONS` clause. For more information, see ["Retrieving Error Code and Error Message"](#).

Topics

- [Syntax](#)
- [Semantics](#)
- [Examples](#)
- [Related Topics](#)

Syntax

sqlerrm_function ::=

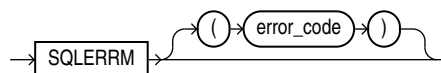

Semantics

sqlerrm_function

error_code

Expression whose value is an Oracle Database error code.

Default: error code associated with the current value of `SQLCODE`.

Like `SQLCODE`, `SQLERRM` without *error_code* is useful only in an exception handler. Outside an exception handler, or if the value of *error_code* is zero, `SQLERRM` returns `ORA-0000`.

If the value of *error_code* is `+100`, `SQLERRM` returns `ORA-01403`.

If the value of *error_code* is a positive number other than `+100`, `SQLERRM` returns this message:

```
-error_code: non-ORACLE exception
```

If the value of *error_code* is a negative number whose absolute value is an Oracle Database error code, `SQLERRM` returns the error message associated with that error code. For example:

```
BEGIN
  DBMS_OUTPUT.PUT_LINE('SQLERRM(-6511): ' || TO_CHAR(SQLERRM(-6511)));
END;
/
```

Result:

```
SQLERRM(-6511): ORA-06511: PL/SQL: cursor already open
```

If the value of *error_code* is a negative number whose absolute value is not an Oracle Database error code, `SQLERRM` returns this message:

```
ORA-error_code: Message error_code not found; product=RDBMS;
facility=ORA
```

For example:

```
BEGIN
  DBMS_OUTPUT.PUT_LINE('SQLERRM(-50000): ' || TO_CHAR(SQLERRM(-50000)));
END;
/
```

Result:

```
SQLERRM(-50000): ORA-50000: Message 50000 not found; product=RDBMS;
facility=ORA
```

Examples

- [Example 11-23](#), "Displaying `SQLCODE` and `SQLERRM` Values"
- [Example 12-13](#), "Handling `FORALL` Exceptions After `FORALL` Statement Completes"
- [Example 12-13](#), "Handling `FORALL` Exceptions After `FORALL` Statement Completes"

Related Topics

In this chapter:

- ["Block"](#)
- ["EXCEPTION_INIT Pragma"](#)
- ["RESTRICT_REFERENCES Pragma"](#)
- ["SQLCODE Function"](#)

In other chapters:

- ["Retrieving Error Code and Error Message"](#)



See Also:

Oracle Database Error Messages Reference for a list of Oracle Database error messages and information about them

13.64 SQL_MACRO Clause

The `SQL_MACRO` clause marks a function as a SQL macro which can be used in a table expression.

A SQL macro referenced in a view is always executed with the view owner's privileges.

The `AUTHID` property cannot be specified. When a SQL macro is invoked, they behave like invoker's right function. The SQL macro owner must grant inherit privileges to the invoking function.

When a macro annotated function is used in PL/SQL, it works like a regular function returning character or `CLOB` type with no macro expansion.

The `SQL_MACRO` annotation can appear in the following SQL statement:

- [CREATE FUNCTION Statement](#)

SQL Macro Usage Restrictions:

- A SQL macro can only appear in `FROM` clause of a query table expression.
- A SQL macro cannot appear in a virtual column expression, functional index, editioning view or materialized view.
- Type methods cannot be annotated with `SQL_MACRO`.

Topics

- [Syntax](#)
- [Semantics](#)
- [Examples](#)
- [Related Topics](#)

Syntax

`sql_macro_clause ::=`

→ `SQL_MACRO` →

Semantics

sql_macro_clause

The *sql_macro_clause* can appear only once in the function. To make a SQL macro function, include the *sql_macro_clause* in the function definition. If you declare the SQL macro function before defining it, you must specify the *sql_macro_clause* in the function declaration.

Restrictions on *sql_macro_clause*

The SQL_MACRO annotation is disallowed with RESULT_CACHE, PARALLEL_ENABLE, and PIPELINED. Although the DETERMINISTIC property cannot be specified, a SQL macro is always implicitly deterministic.

The SQL macro function must have a return type of VARCHAR2, CHAR, or CLOB.

Examples

Example 13-22 Budget : Using a SQL Macro in a Table Expression

This example shows the SQL macro named budget used in a table expression to return the total salary in each department for employees for a given job title.

```
CREATE FUNCTION budget(job VARCHAR2) RETURN VARCHAR2 SQL_MACRO IS
BEGIN
    RETURN q'{SELECT deptno, SUM(sal) budget
              FROM scott.emp
              WHERE job = budget.job
              GROUP BY deptno}';
END;
/
```

This query shows the SQL macro budget used in a table expression.

```
SELECT * FROM budget('MANAGER');
```

Result:

DEPTNO	BUDGET
20	2975
30	2850
10	2450

Example 13-23 Take: Using a Table Macro with a Polymorphic View

This example creates a table macro named take which returns the first n rows from table t.

```
CREATE FUNCTION take (n NUMBER, t DBMS_TF.TABLE_T)
RETURN VARCHAR2 SQL_MACRO IS
BEGIN
    RETURN 'SELECT * FROM t FETCH FIRST take.n ROWS ONLY';
```

```
END;
/
```

The query returns the first two rows from table dept.

```
SELECT * FROM take(2, dept);
```

Result:

DEPTNO	DNAME	LOC
10	ACCOUNTING	NEW YORK
20	RESEARCH	DALLAS

You can use SQL Macros with bind variables and more complex SQL constructs.

```
VAR row_count NUMBER;
EXEC :row_count := 5
```

```
WITH t AS (SELECT * FROM emp NATURAL JOIN dept ORDER BY ename)
SELECT ename, dname FROM take(:row_count, t);
```

Result:

ENAME	DNAME
ADAMS	RESEARCH
ALLEN	SALES
BLAKE	SALES
CLARK	ACCOUNTING
FORD	RESEARCH

Related Topics

- [Overview of Polymorphic Table Functions](#)
- *Oracle Database PL/SQL Packages and Types Reference* for more information about how to specify the PTF implementation package and use the `DBMS_TF` utilities

13.65 %TYPE Attribute

The `%TYPE` attribute lets you declare a constant, variable, collection element, record field, or subprogram parameter to be of the same data type as a previously declared variable or column (without knowing what that type is).

The `%TYPE` attribute cannot be used if the referenced character column has a collation other than `USING_NLS_COMP`.

The item declared with `%TYPE` is the **referencing item**, and the previously declared item is the **referenced item**.

The referencing item inherits the following from the referenced item:

- Data type and size
- Constraints (unless the referenced item is a column)

The referencing item does not inherit the initial value of the referenced item.

If the declaration of the referenced item changes, then the declaration of the referencing item changes accordingly.

Topics

- [Syntax](#)
- [Semantics](#)
- [Examples](#)
- [Related Topics](#)

Syntax

type_attribute ::=

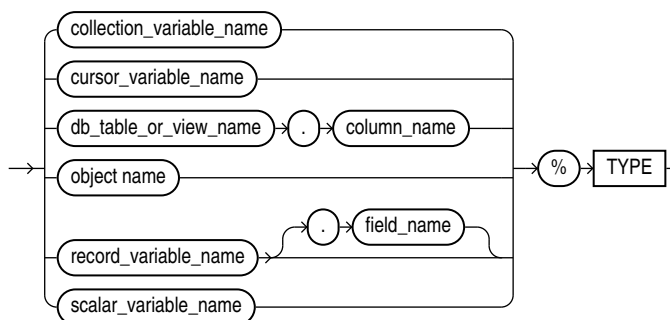

Semantics

type_attribute

collection_variable_name

Name of a collection variable.

Restriction on *collection_variable_name*

In a constant declaration, *collection_variable* cannot be an associative array variable.

cursor_variable_name

Name of a cursor variable.

db_table_or_view_name

Name of a database table or view that is accessible when the declaration is elaborated.

column_name

Name of a column of *db_table_or_view*.

object_name

Name of an instance of an ADT.

record_variable_name

Name of a record variable.

field_name

Name of a field of *record_variable*.

scalar_variable_name

Name of a scalar variable.

Examples

- [Example 2-15](#), "Declaring Variable of Same Type as Column"
- [Example 2-16](#), "Declaring Variable of Same Type as Another Variable"

Related Topics

In this chapter:

- ["Constant Declaration"](#)
- ["%ROWTYPE Attribute"](#)
- ["Scalar Variable Declaration"](#)

In other chapters:

- [About Data-Bound Collation](#)
- ["Declaring Items using the %TYPE Attribute"](#)

13.66 UDF Pragma

The `UDF` pragma tells the compiler that the PL/SQL unit is a **user defined function** that is used primarily in SQL statements, which might improve its performance.

Syntax

udf_pragma ::=

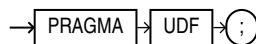

13.67 UPDATE Statement Extensions

PL/SQL extends the *update_set_clause* and *where_clause* of the SQL `UPDATE` statement as follows:

- In the *update_set_clause*, you can specify a record. For each selected row, the `UPDATE` statement updates each column with the value of the corresponding record field.
- In the *where_clause*, you can specify a `CURRENT OF` clause, which restricts the `UPDATE` statement to the current row of the specified cursor.

 **See Also:**

Oracle Database SQL Language Reference for the syntax of the SQL UPDATE statement

Topics

- [Syntax](#)
- [Semantics](#)
- [Examples](#)
- [Related Topics](#)

Syntax

update_set_clause ::=

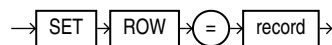

where_clause ::=

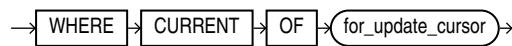
**Semantics**

update_set_clause

record

Name of a record variable that represents a row of the item described by *dml_table_expression_clause*. That is, for every column of the row, the record must have a field with a compatible data type. If a column has a NOT NULL constraint, then its corresponding field cannot have a NULL value.

where_clause

for_update_cursor

Name of a FOR UPDATE cursor; that is, an explicit cursor associated with a FOR SELECT UPDATE statement.

Examples

- [Example 5-55](#), "Updating Rows with Records"

Related Topics

In this chapter:

- ["Explicit Cursor Declaration and Definition"](#)
- ["Record Variable Declaration"](#)
- ["%ROWTYPE Attribute"](#)

In other chapters:

- ["Updating Rows with Records"](#)
- ["Restrictions on Record Inserts and Updates"](#)
- ["SELECT FOR UPDATE and FOR UPDATE Cursors"](#)

13.68 WHILE LOOP Statement

The `WHILE LOOP` statement runs one or more statements while a condition is `TRUE`. The `WHILE LOOP` statement ends when the condition becomes `FALSE` or `NULL`, or when a statement inside the loop transfers control outside the loop or raises an exception.

Topics

- [Syntax](#)
- [Semantics](#)
- [Examples](#)
- [Related Topics](#)

Syntax

while_loop_statement ::=



(*boolean_expression ::=* , *statement ::=*)

Semantics

while_loop_statement

boolean_expression

Expression whose value is `TRUE`, `FALSE`, or `NULL`.

boolean_expression is evaluated at the beginning of each iteration of the loop. If its value is `TRUE`, the statements after `LOOP` run. Otherwise, control transfers to the statement after the `WHILE LOOP` statement.

statement

To prevent an infinite loop, at least one statement must change the value of *boolean_expression* to `FALSE` or `NULL`, transfer control outside the loop, or raise an exception. The statements that can transfer control outside the loop are:

- ["CONTINUE Statement"](#) (when it transfers control to the next iteration of an enclosing labeled loop)

- ["EXIT Statement"](#)
- ["GOTO Statement"](#)
- ["RAISE Statement"](#)

label

Label that identifies *while_loop_statement* (see "[statement ::=](#)" and "[label](#)"). `CONTINUE`, `EXIT`, and `GOTO` statements can reference this label.

Labels improve readability, especially when `LOOP` statements are nested, but only if you ensure that the label in the `END LOOP` statement matches a label at the beginning of the same `LOOP` statement (the compiler does not check).

Examples

- [Example 4-28, "WHILE LOOP Statements"](#)

Related Topics

In this chapter:

- ["Basic LOOP Statement"](#)
- ["CONTINUE Statement"](#)
- ["Cursor FOR LOOP Statement"](#)
- ["EXIT Statement"](#)
- ["Explicit Cursor Declaration and Definition"](#)
- ["FETCH Statement"](#)
- ["FOR LOOP Statement"](#)
- ["FORALL Statement"](#)
- ["OPEN Statement"](#)

In other chapters:

- ["WHILE LOOP Statement"](#)

SQL Statements for Stored PL/SQL Units

This chapter explains how to use the SQL statements that create, change, and drop stored PL/SQL units.

CREATE [OR REPLACE] Statements

Each of these SQL statements creates a PL/SQL unit at schema level and stores it in the database:

- [CREATE FUNCTION Statement](#)
- [CREATE LIBRARY Statement](#)
- [CREATE PACKAGE Statement](#)
- [CREATE PACKAGE BODY Statement](#)
- [CREATE PROCEDURE Statement](#)
- [CREATE TRIGGER Statement](#)
- [CREATE TYPE Statement](#)
- [CREATE TYPE BODY Statement](#)

Each of these `CREATE` statements has an optional `OR REPLACE` clause. Specify `OR REPLACE` to re-create an existing PL/SQL unit—that is, to change its declaration or definition without dropping it, re-creating it, and regranteeing object privileges previously granted on it. If you redefine a PL/SQL unit, the database recompiles it.

Caution:

A `CREATE OR REPLACE` statement does not issue a warning before replacing the existing PL/SQL unit.

None of these `CREATE` statements can appear in a PL/SQL block.

ALTER Statements

To recompile an existing PL/SQL unit without re-creating it (without changing its declaration or definition), use one of these SQL statements:

- [ALTER FUNCTION Statement](#)
- [ALTER LIBRARY Statement](#)
- [ALTER PACKAGE Statement](#)
- [ALTER PROCEDURE Statement](#)
- [ALTER TRIGGER Statement](#)
- [ALTER TYPE Statement](#)

Reasons to use an `ALTER` statement are:

- To explicitly recompile a stored unit that has become invalid, thus eliminating the need for implicit runtime recompilation and preventing associated runtime compilation errors and performance overhead.
- To recompile a stored unit with different compilation parameters.
- To enable or disable a trigger.
- To specify the `EDITIONABLE` or `NONEDITIONABLE` property of a stored unit whose schema object type is not yet editionable in its schema.

The `ALTER TYPE` statement has additional uses.

DROP Statements

To drop an existing PL/SQL unit from the database, use one of these SQL statements:

- [DROP FUNCTION Statement](#)
- [DROP LIBRARY Statement](#)
- [DROP PACKAGE Statement](#)
- [DROP PROCEDURE Statement](#)
- [DROP TRIGGER Statement](#)
- [DROP TYPE Statement](#)
- [DROP TYPE BODY Statement](#)

Related Topics

- For instructions for reading the syntax diagrams in this chapter, see *Oracle Database SQL Language Reference*.
- For information about editioned and noneditioned objects, see *Oracle Database Development Guide*.
- For information about compilation parameters, see "[PL/SQL Units and Compilation Parameters](#)".

14.1 ALTER FUNCTION Statement

The `ALTER FUNCTION` statement explicitly recompiles a standalone function.

Explicit recompilation eliminates the need for implicit runtime recompilation and prevents associated runtime compilation errors and performance overhead.

Note:

This statement does not change the declaration or definition of an existing function. To redeclare or redefine a standalone function, use the "[CREATE FUNCTION Statement](#)" with the `OR REPLACE` clause.

Topics

- [Prerequisites](#)
- [Syntax](#)
- [Semantics](#)
- [Example](#)
- [Related Topics](#)

Prerequisites

If the function is in the `SYS` schema, you must be connected as `SYSDBA`. Otherwise, the function must be in your schema or you must have `ALTER ANY PROCEDURE` system privilege.

Syntax

alter_function ::=

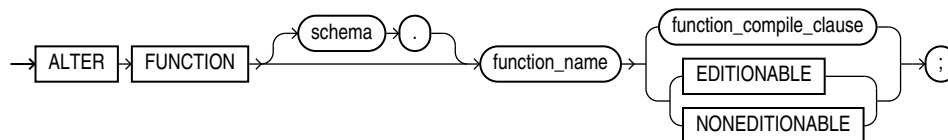

function_compile_clause ::=

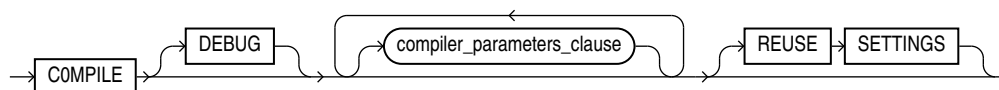

(compiler_parameters_clause ::=)

Semantics

alter_function

schema

Name of the schema containing the function. **Default:** your schema.

function_name

Name of the function to be recompiled.

{ EDITIONABLE | NONEDITIONABLE }

Specifies whether the function becomes an editioned or noneditioned object if editioning is later enabled for the schema object type `FUNCTION` in *schema*. **Default:** `EDITIONABLE`. For information about altering editioned and noneditioned objects, see *Oracle Database Development Guide*.

function_compile_clause

Recompiles the function, whether it is valid or invalid.

See [compile_clause](#) semantics.

See also [DEFAULT COLLATION Clause](#) compilation semantics.

Example**Example 14-1 Recompiling a Function**

To explicitly recompile the function `get_bal` owned by the sample user `oe`, issue this statement:

```
ALTER FUNCTION oe.get_bal COMPILE;
```

If the database encounters no compilation errors while recompiling `get_bal`, then `get_bal` becomes valid. The database can subsequently run it without recompiling it at run time. If recompiling `get_bal` results in compilation errors, then the database returns an error, and `get_bal` remains invalid.

The database also invalidates all objects that depend upon `get_bal`. If you subsequently reference one of these objects without explicitly recompiling it first, then the database recompiles it implicitly at run time.

Related Topics

- ["CREATE FUNCTION Statement"](#)
- ["DROP FUNCTION Statement"](#)

14.2 ALTER LIBRARY Statement

The `ALTER LIBRARY` statement explicitly recompiles a library.

Explicit recompilation eliminates the need for implicit runtime recompilation and prevents associated runtime compilation errors and performance overhead.

 **Note:**

This statement does not change the declaration or definition of an existing library. To redeclare or redefine a library, use the ["CREATE LIBRARY Statement"](#) with the `OR REPLACE` clause.

Topics

- [Prerequisites](#)
- [Syntax](#)
- [Semantics](#)
- [Example](#)
- [Related Topics](#)

Prerequisites

If the library is in the `SYS` schema, you must be connected as `SYSDBA`. Otherwise, the library must be in your schema or you must have the `ALTER ANY LIBRARY` system privilege.

Syntax

alter_library ::=

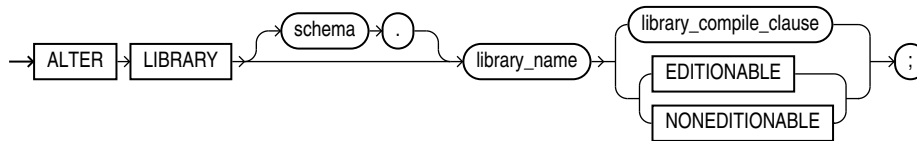

library_compile_clause ::=

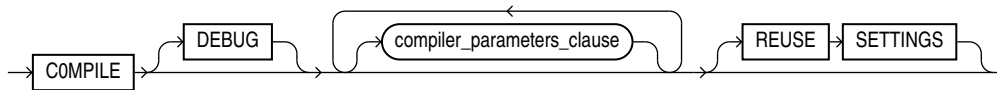

(compiler_parameters_clause ::=)

Semantics

alter_library

library_name

Name of the library to be recompiled.

{ EDITIONABLE | NONEDITIONABLE }

Specifies whether the library becomes an editioned or noneditioned object if editioning is later enabled for the schema object type `LIBRARY` in *schema*. **Default:** `EDITIONABLE`. For information about altering editioned and noneditioned objects, see *Oracle Database Development Guide*.

library_compile_clause

Recompiles the library.

See [compile_clause](#) and [compiler_parameters_clause](#) semantics.

Example

Example 14-2 Recompiling a Library

To explicitly recompile the library `my_ext_lib` owned by the sample user `hr`, issue this statement:

```
ALTER LIBRARY hr.my_ext_lib COMPILE;
```

If the database encounters no compilation errors while recompiling `my_ext_lib`, then `my_ext_lib` becomes valid. The database can subsequently run it without recompiling it at

run time. If recompiling `my_ext_lib` results in compilation errors, then the database returns an error, and `my_ext_lib` remains invalid.

The database also invalidates all objects that depend upon `my_ext_lib`. If you subsequently reference one of these objects without explicitly recompiling it first, then the database recompiles it implicitly at run time.

Related Topics

- ["CREATE LIBRARY Statement"](#)
- ["DROP LIBRARY Statement"](#)

14.3 ALTER PACKAGE Statement

The `ALTER PACKAGE` statement explicitly recompiles a package specification, body, or both. Explicit recompilation eliminates the need for implicit runtime recompilation and prevents associated runtime compilation errors and performance overhead.

Because all objects in a package are stored as a unit, the `ALTER PACKAGE` statement recompiles all package objects. You cannot use the `ALTER PROCEDURE` statement or `ALTER FUNCTION` statement to recompile individually a procedure or function that is part of a package.



Note:

This statement does not change the declaration or definition of an existing package. To redeclare or redefine a package, use the ["CREATE PACKAGE Statement"](#), or the ["CREATE PACKAGE BODY Statement"](#) with the `OR REPLACE` clause.

Topics

- [Prerequisites](#)
- [Syntax](#)
- [Semantics](#)
- [Examples](#)
- [Related Topics](#)

Prerequisites

If the package is in the `SYS` schema, you must be connected as `SYSDBA`. Otherwise, the package must be in your schema or you must have `ALTER ANY PROCEDURE` system privilege.

Syntax

alter_package ::=

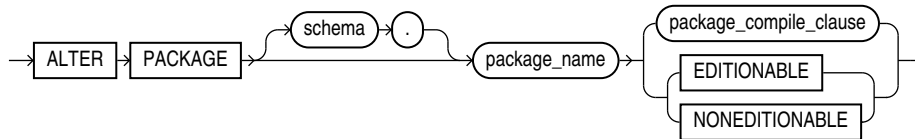

package_compile_clause ::=

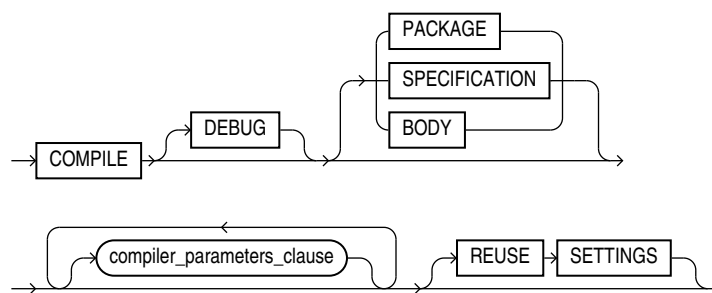

(compiler_parameters_clause ::=)

Semantics

alter_package

schema

Name of the schema containing the package. **Default:** your schema.

package_name

Name of the package to be recompiled.

{ EDITIONABLE | NONEDITIONABLE }

Specifies whether the package becomes an editioned or noneditioned object if editioning is later enabled for the schema object type `PACKAGE` in *schema*. **Default:** `EDITIONABLE`. For information about altering editioned and noneditioned objects, see *Oracle Database Development Guide*.

package_compile_clause

Recompiles the package specification, body, or both.

See [compile_clause](#) and [compiler_parameters_clause](#) semantics.

Examples

Example 14-3 Recompiling a Package

This statement explicitly recompiles the specification and body of the `hr.emp_mgmt` package.

See "[CREATE PACKAGE Statement](#)" for the example that creates this package.

```
ALTER PACKAGE emp_mgmt COMPILE PACKAGE;
```

If the database encounters no compilation errors while recompiling the `emp_mgmt` specification and body, then `emp_mgmt` becomes valid. The user `hr` can subsequently invoke or reference all package objects declared in the specification of `emp_mgmt` without runtime recompilation. If recompiling `emp_mgmt` results in compilation errors, then the database returns an error and `emp_mgmt` remains invalid.

The database also invalidates all objects that depend upon `emp_mgmt`. If you subsequently reference one of these objects without explicitly recompiling it first, then the database recompiles it implicitly at run time.

To recompile the body of the `emp_mgmt` package in the schema `hr`, issue this statement:

```
ALTER PACKAGE hr.emp_mgmt COMPILE BODY;
```

If the database encounters no compilation errors while recompiling the package body, then the body becomes valid. The user `hr` can subsequently invoke or reference all package objects declared in the specification of `emp_mgmt` without runtime recompilation. If recompiling the body results in compilation errors, then the database returns an error message and the body remains invalid.

Because this statement recompiles the body and not the specification of `emp_mgmt`, the database does not invalidate dependent objects.

Related Topics

- "[CREATE PACKAGE Statement](#)"
- "[DROP PACKAGE Statement](#)"

14.4 ALTER PROCEDURE Statement

The `ALTER PROCEDURE` statement explicitly recompiles a standalone procedure.

Explicit recompilation eliminates the need for implicit runtime recompilation and prevents associated runtime compilation errors and performance overhead.

To recompile a procedure that is part of a package, recompile the entire package using the "[ALTER PACKAGE Statement](#)").



Note:

This statement does not change the declaration or definition of an existing procedure. To redeclare or redefine a standalone procedure, use the "[CREATE PROCEDURE Statement](#)" with the `OR REPLACE` clause.

The `ALTER PROCEDURE` statement is very similar to the `ALTER FUNCTION` statement. See "[ALTER FUNCTION Statement](#)" for more information.

Topics

- [Prerequisites](#)
- [Syntax](#)
- [Semantics](#)
- [Example](#)
- [Related Topics](#)

Prerequisites

If the procedure is in the `SYS` schema, you must be connected as `SYSDBA`. Otherwise, the procedure must be in your schema or you must have `ALTER ANY PROCEDURE` system privilege.

Syntax

alter_procedure ::=

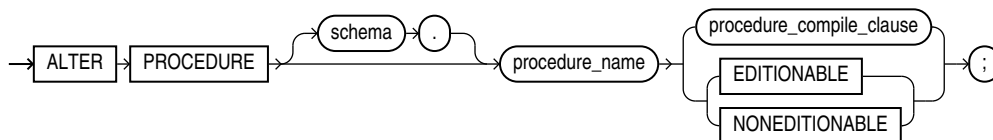

procedure_compile_clause ::=

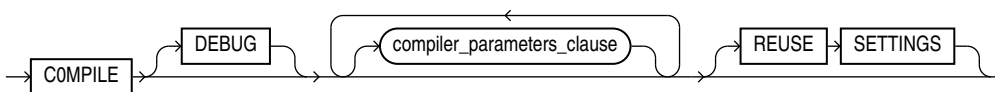

(compiler_parameters_clause ::=)

Semantics

alter_procedure

schema

Name of the schema containing the procedure. **Default:** your schema.

procedure_name

Name of the procedure to be recompiled.

{ EDITIONABLE | NONEDITIONABLE }

Specifies whether the procedure becomes an editioned or noneditioned object if editioning is later enabled for the schema object type `PROCEDURE` in *schema*. **Default:** `EDITIONABLE`. For information about altering editioned and noneditioned objects, see *Oracle Database Development Guide*.

procedure_compile_clause

See [compile_clause](#) and [compiler_parameters_clause](#) semantics.

Example**Example 14-4 Recompiling a Procedure**

To explicitly recompile the procedure `remove_emp` owned by the user `hr`, issue this statement:

```
ALTER PROCEDURE hr.remove_emp COMPILE;
```

If the database encounters no compilation errors while recompiling `remove_emp`, then `remove_emp` becomes valid. The database can subsequently run it without recompiling it at run time. If recompiling `remove_emp` results in compilation errors, then the database returns an error and `remove_emp` remains invalid.

the database also invalidates all dependent objects. These objects include any procedures, functions, and package bodies that invoke `remove_emp`. If you subsequently reference one of these objects without first explicitly recompiling it, then the database recompiles it implicitly at run time.

Related Topics

- ["CREATE PROCEDURE Statement"](#)
- ["DROP PROCEDURE Statement"](#)

14.5 ALTER TRIGGER Statement

The `ALTER TRIGGER` statement enables, disables, compiles, or renames a database trigger.

 **Note:**

This statement does not change the declaration or definition of an existing trigger. To redeclare or redefine a trigger, use the "[CREATE TRIGGER Statement](#)" with the `OR REPLACE` clause.

Topics

- [Prerequisites](#)
- [Syntax](#)
- [Semantics](#)
- [Examples](#)
- [Related Topics](#)

Prerequisites

If the trigger is in the `sys` schema, you must be connected as `sysdba`. Otherwise, the trigger must be in your schema or you must have `ALTER ANY TRIGGER` system privilege.

In addition, to alter a trigger on `database`, you must have the `ADMINISTER DATABASE TRIGGER` system privilege.



See Also:

"[CREATE TRIGGER Statement](#)" for more information about triggers based on `database` triggers

Syntax

alter_trigger ::=

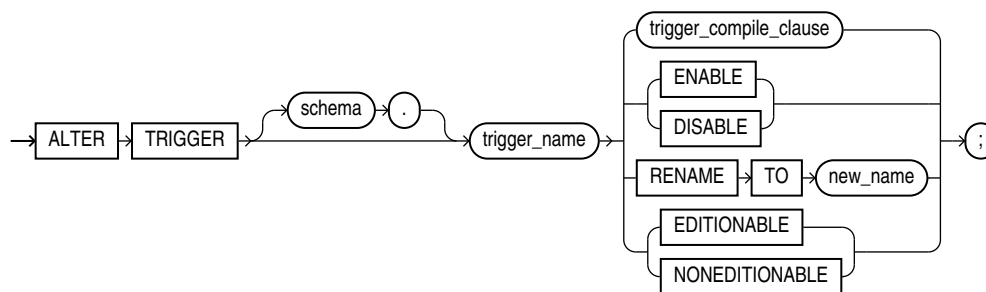

trigger_compile_clause ::=

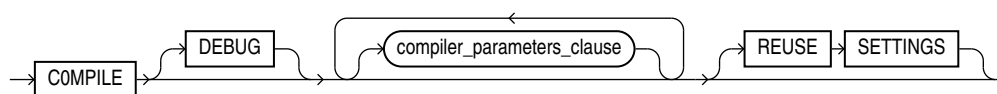

(compiler_parameters_clause ::=)

Semantics

alter_trigger

schema

Name of the schema containing the trigger. **Default:** your schema.

trigger_name

Name of the trigger to be altered.

[ENABLE | DISABLE]

Enables or disables the trigger.

RENAME TO *new_name*

Renames the trigger without changing its state.

When you rename a trigger, the database rebuilds the remembered source of the trigger in the *_SOURCE static data dictionary views. As a result, comments and formatting may change in the TEXT column of those views even though the trigger source did not change.

{ EDITIONABLE | NONEDITIONABLE }

Specifies whether the trigger becomes an editioned or noneditioned object if editioning is later enabled for the schema object type TRIGGER in *schema*. **Default:** EDITIONABLE. For information about altering editioned and noneditioned objects, see *Oracle Database Development Guide*.

Restriction on NONEDITIONABLE

You cannot specify NONEDITIONABLE for a crossedition trigger.

trigger_compile_clause

Recompiles the trigger, whether it is valid or invalid.

See [compile_clause](#) and [compiler_parameters_clause](#) semantics.

Examples**Example 14-5 Disabling Triggers**

The sample schema `hr` has a trigger named `update_job_history` created on the `employees` table. The trigger fires whenever an UPDATE statement changes an employee's `job_id`. The trigger inserts into the `job_history` table a row that contains the employee's ID, begin and end date of the last job, and the job ID and department.

When this trigger is created, the database enables it automatically. You can subsequently disable the trigger with this statement:

```
ALTER TRIGGER update_job_history DISABLE;
```

When the trigger is disabled, the database does not fire the trigger when an UPDATE statement changes an employee's job.

Example 14-6 Enabling Triggers

After disabling the trigger, you can subsequently enable it with this statement:

```
ALTER TRIGGER update_job_history ENABLE;
```

After you reenable the trigger, the database fires the trigger whenever an UPDATE statement changes an employee's job. If an employee's job is updated while the trigger is disabled, then the database does not automatically fire the trigger for this employee until another transaction changes the `job_id` again.

Related Topics

In this chapter:

- ["CREATE TRIGGER Statement"](#)

- ["DROP TRIGGER Statement"](#)

In other chapters:

- ["Trigger Compilation, Invalidation, and Recompilation"](#)
- ["Trigger Enabling and Disabling"](#)

14.6 ALTER TYPE Statement

Use the ALTER TYPE statement to add or drop member attributes or methods. You can change the existing properties of an object type, and you can modify the scalar attributes of the type. You can also use this statement to recompile the specification or body of the type or to change the specification of an object type by adding new object member subprogram specifications.

The ALTER TYPE statement does one of the following to a type that was created with ["CREATE TYPE Statement"](#) and ["CREATE TYPE BODY Statement"](#):

- **Evolve** the type; that is, adds or drops member attributes or methods.
For more information about type evolution, see *Oracle Database Object-Relational Developer's Guide*.
- Changes the specification of the type by adding object member subprogram specifications.
- Recompiles the specification or body of the type.
- Resets the version of the type to 1, so that it is no longer considered to be evolved.

Topics

- [Prerequisites](#)
- [Syntax](#)
- [Semantics](#)
- [Examples](#)
- [Related Topics](#)

Prerequisites

If the type is in the SYS schema, you must be connected as SYSDBA. Otherwise, the type must be in your schema and you must have CREATE TYPE or CREATE ANY TYPE system privilege, or you must have ALTER ANY TYPE system privileges.

Syntax

alter_type ::=

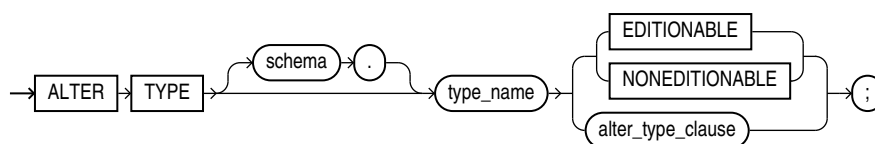

alter_type_clause ::=

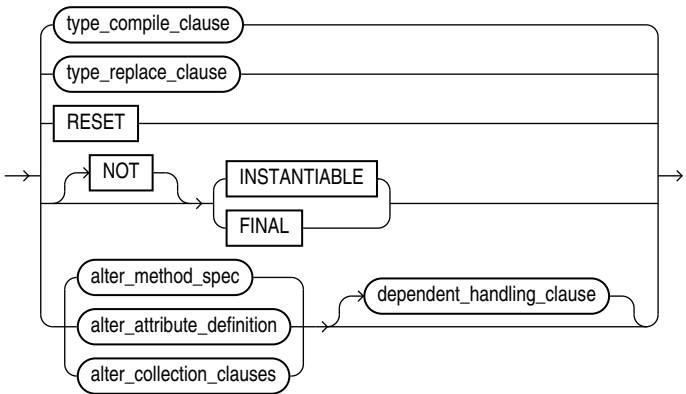

(`type_compile_clause ::=`, `type_replace_clause ::=`, `alter_attribute_definition ::=`,
`alter_method_spec ::=`, `alter_collections_clauses ::=`, `dependent_handling_clause ::=`)

type_compile_clause ::=

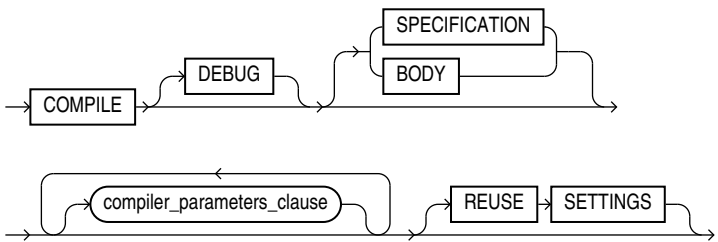

(`compiler_parameters_clause ::=`)

type_replace_clause ::=

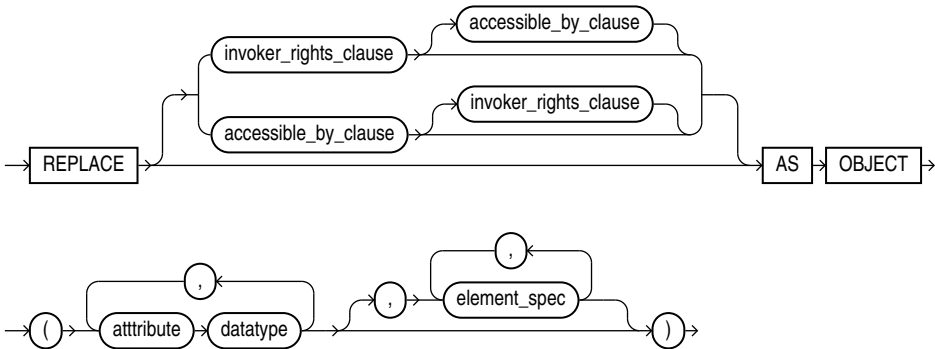

(`accessible_by_clause ::=`, `invoker_rights_clause ::=`, `element_spec ::=`)

alter_method_spec ::=

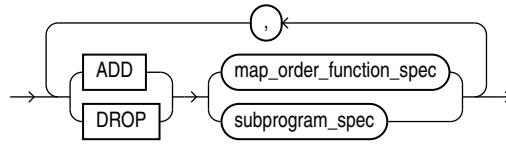

(*map_order_function_spec ::=*, *subprogram_spec ::=*)

alter_attribute_definition ::=

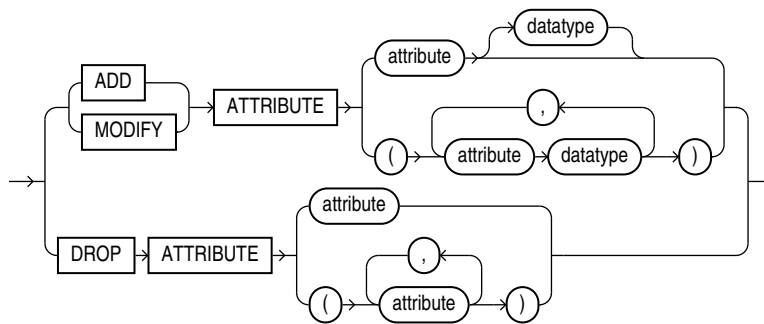

alter_collections_clauses ::=

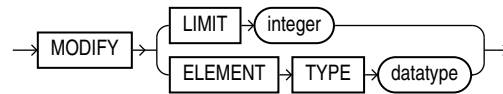

dependent_handling_clause ::=

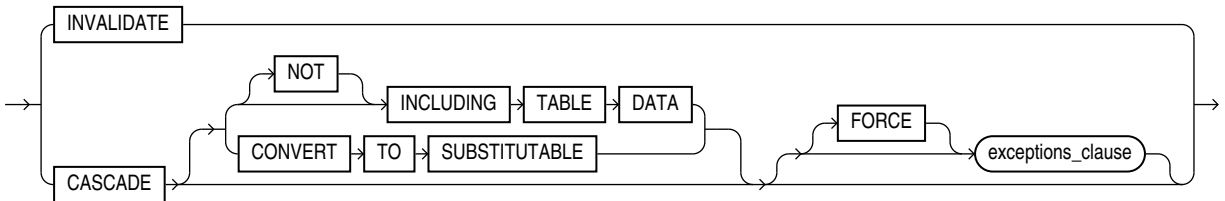

exceptions_clause ::=

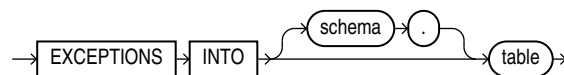

Semantics

alter_type

schema

Name of the schema containing the type. **Default:** your schema.

type_name

Name of an ADT, `VARRAY` type, or nested table type.

Restriction on *type_name*

You cannot evolve an editioned ADT.

The `ALTER TYPE` statement fails with ORA-22348 if either of the following is true:

- The type is an editioned ADT and the `ALTER TYPE` statement has no `type_compile_clause`.
(You can use the `ALTER TYPE` statement to recompile an editioned object type, but not for any other purpose.)
- The type has a dependent that is an editioned ADT and the `ALTER TYPE` statement has a `CASCADE` clause.

An **editioned object** is a schema object that has an editionable object type and was created by a user for whom editions are enabled.

{ `EDITIONABLE` | `NONEDITIONABLE` }

Specifies whether the type becomes an editioned or noneditioned object if editioning is later enabled for the schema object type `TYPE` in *schema*. **Default:** `EDITIONABLE`. For information about altering editioned and noneditioned objects, see *Oracle Database Development Guide*.

alter_type_clause

RESET

Resets the version of this type to 1, so that it is no longer considered to be evolved.



Note:

Resetting the version of this type to 1 invalidates all of its dependents.

`RESET` is intended for evolved ADTs that are preventing their owners from being editions-enabled. For information about enabling editions for users, see *Oracle Database Development Guide*.

To see the version number of an ADT, select `VERSION#` from the static data dictionary view `*_TYPE_VERSIONS`. For example:

```
SELECT Version#
FROM DBA_TYPE_VERSIONS
WHERE Owner = schema
```

```
AND Name = 'type_name'  
AND Type = 'TYPE'
```

For an evolved ADT, the preceding query returns multiple rows with different version numbers. `RESET` deletes every row whose version number is less than the maximum version number, and resets the version number of the remaining rows to 1.

Restriction on `RESET`

You cannot specify `RESET` if the type has any table dependents (direct or indirect).

[`NOT`] `INSTANTIABLE`

Specify `INSTANTIABLE` if object instances of this type can be constructed.

Specify `NOT INSTANTIABLE` if no constructor (default or user-defined) exists for this type. You must specify these keywords for any type with noninstantiable methods and for any type that has no attributes (either inherited or specified in this statement).

Restriction on `NOT INSTANTIABLE`

You cannot change a user-defined type from `INSTANTIABLE` to `NOT INSTANTIABLE` if the type has any table dependents.

[`NOT`] `FINAL`

Specify `FINAL` if no further subtypes can be created for this type.

Specify `NOT FINAL` if further subtypes can be created under this type.

If you change the property from `FINAL` to `NOT FINAL`, or the reverse, then you must specify the `CASCADE` clause of the "*dependent_handling_clause*" to convert data in dependent columns and tables. Specifically:

- If you change a type from `NOT FINAL` to `FINAL`, then you must specify `CASCADE [INCLUDING TABLE DATA]`. You cannot defer data conversion with `CASCADE NOT INCLUDING TABLE DATA`.
- If you change a type from `FINAL` to `NOT FINAL`, then:
 - Specify `CASCADE INCLUDING TABLE DATA` if you want to create substitutable tables and columns of that type, but you are not concerned about the substitutability of the existing dependent tables and columns.

The database marks all existing dependent columns and tables `NOT SUBSTITUTABLE AT ALL LEVELS`, so you cannot insert the subtype instances of the altered type into these existing columns and tables.
 - Specify `CASCADE CONVERT TO SUBSTITUTABLE` if you want to create substitutable tables and columns of the type and also store subtype instances of the altered type in existing dependent tables and columns.

The database marks all existing dependent columns and tables `SUBSTITUTABLE AT ALL LEVELS` except those that are explicitly marked `NOT SUBSTITUTABLE AT ALL LEVELS`.

 **See Also:**

Oracle Database Object-Relational Developer's Guide for a full discussion of ADT evolution

Restriction on FINAL

You cannot change a user-defined type from `NOT FINAL` to `FINAL` if the type has any subtypes.

type_compile_clause

(Default) Recompile the type specification and body.

See [compile_clause](#) and [compiler_parameters_clause](#) semantics.

type_replace_clause

Starting with Oracle Database 12c Release 2 (12.2), the *type_replace_clause* is deprecated. Use the *alter_method_spec* clause instead. Alternatively, you can recreate the type using the `CREATE OR REPLACE TYPE` statement.

Adds member subprogram specifications.

Restriction on *type_replace_clause*

This clause is valid only for ADTs, not for nested tables or varrays.

attribute

Name of an object attribute. Attributes are data items with a name and a type specifier that form the structure of the object.

element_spec

Specifies elements of the redefined object.

alter_method_spec

Adds a method to or drops a method from the type. The database disables any function-based indexes that depend on the type.

In one `ALTER TYPE` statement you can add or drop multiple methods, but you can reference each method only once.

ADD

When you add a method, its name must not conflict with any existing attributes in its type hierarchy.

DROP

When you drop a method, the database removes the method from the target type.

Restriction on DROP

You cannot drop from a subtype a method inherited from its supertype. Instead you must drop the method from the supertype.

alter_attribute_definition

Adds, drops, or modifies an attribute of an ADT. In one `ALTER TYPE` statement, you can add, drop, or modify multiple member attributes or methods, but you can reference each attribute or method only once.

ADD ATTRIBUTE

Name of the attribute must not conflict with existing attributes or methods in the type hierarchy. The database adds the attribute to the end of the locally defined attribute list.

If you add the attribute to a supertype, then it is inherited by all of its subtypes. In subtypes, inherited attributes always precede declared attributes. Therefore, you might need to update the mappings of the implicitly altered subtypes after adding an attribute to a supertype.

DROP ATTRIBUTE

When you drop an attribute from a type, the database drops the column corresponding to the dropped attribute and any indexes, statistics, and constraints referencing the dropped attribute.

You need not specify the data type of the attribute you are dropping.

Restrictions on DROP ATTRIBUTE

- You cannot drop an attribute inherited from a supertype. Instead you must drop the attribute from the supertype.
- You cannot drop an attribute that is part of a partitioning, subpartitioning, or cluster key.

Caution:

If you use the `INVALIDATE` option, then the compiler does not check dependents; therefore, this rule is not enforced. However, dropping such an attribute leaves the table in an unusable state.

- You cannot drop an attribute of a primary-key-based object identifier of an object table or a primary key of an index-organized table.
- You cannot drop all of the attributes of a root type. Instead you must drop the type. However, you can drop all of the locally declared attributes of a subtype.

MODIFY ATTRIBUTE

Modifies the data type of an existing scalar attribute. For example, you can increase the length of a `VARCHAR2` or `RAW` attribute, or you can increase the precision or scale of a numeric attribute.

Restriction on MODIFY ATTRIBUTE

You cannot expand the size of an attribute referenced in a function-based index, domain index, or cluster key.

alter_collection_clauses

These clauses are valid only for collection types.

MODIFY LIMIT *integer*

Increases the number of elements in a varray. It is not valid for nested tables. Specify an integer greater than the current maximum number of elements in the varray.

MODIFY ELEMENT TYPE *datatype*

Increases the precision, size, or length of a scalar data type of a varray or nested table. This clause is not valid for collections of ADTs.

- For a collection of `NUMBER`, you can increase the precision or scale.
- For a collection of `RAW`, you can increase the maximum size.
- For a collection of `VARCHAR2` or `NVARCHAR2`, you can increase the maximum length.

dependent_handling_clause

Specifies how the database is to handle objects that are dependent on the modified type. If you omit this clause, then the `ALTER TYPE` statement terminates if the type has any dependent type or table.

INVALIDATE

Invalidates all dependent objects without any checking mechanism. Starting with Oracle Database 12c Release 2 (12.2), the `INVALIDATE` command is deprecated. Oracle recommends that you use the `CASCADE` clause instead.

Caution:

The database does not validate the type change, so use this clause with caution. For example, if you drop an attribute that is a partitioning or cluster key, then the table becomes unusable.

CASCADE

Propagates the type change to dependent types and tables. The database terminates the statement if any errors are found in the dependent types or tables unless you also specify `FORCE`.

If you change the property of the type between `FINAL` and `NOT FINAL`, then you must specify this clause to convert data in dependent columns and tables.

INCLUDING TABLE DATA

(Default) Converts data stored in all user-defined columns to the most recent version of the column type.

Note:

You must specify this clause if your column data is in Oracle database version 8.0 image format. This clause is also required if you are changing the type property between `FINAL` and `NOT FINAL`.

- For each attribute added to the column type, the database adds an attribute to the data and initializes it to null.
- For each attribute dropped from the referenced type, the database removes the corresponding attribute data from each row in the table.

If you specify `INCLUDING TABLE DATA`, then all of the tablespaces containing the table data must be in read/write mode.

If you specify `NOT INCLUDING TABLE DATA`, then the database upgrades the metadata of the column to reflect the changes to the type but does not scan the dependent column and update the data as part of this `ALTER TYPE` statement. However, the dependent column data remains accessible, and the results of subsequent queries of the data reflect the type modifications.

CONVERT TO SUBSTITUTABLE

Specify this clause if you are changing the type from `FINAL` to `NOT FINAL` and you want to create substitutable tables and columns of the type and also store subtype instances of the altered type in existing dependent tables and columns.

exceptions_clause

FORCE

Specify `FORCE` if you want the database to ignore the errors from dependent tables and indexes and log all errors in the specified exception table. The exception table must have been created by running the `DBMS_UTILITY.CREATE_ALTER_TYPE_ERROR_TABLE` procedure.

Examples

See "[CREATE TYPE Statement](#)" for examples creating the types referenced in these examples.

Example 14-7 Adding a Member Function

This example uses the ADT `data_typ1`.

A method is added to `data_typ1` and its type body is modified to correspond. The date formats are consistent with the `order_date` column of the `oe.orders` sample table.

```
ALTER TYPE data_typ1
  ADD MEMBER FUNCTION qtr(der_qtr DATE)
  RETURN CHAR CASCADE;

CREATE OR REPLACE TYPE BODY data_typ1 IS
  MEMBER FUNCTION prod (invent NUMBER) RETURN NUMBER IS
  BEGIN
    RETURN (year + invent);
  END;
  MEMBER FUNCTION qtr(der_qtr DATE) RETURN CHAR IS
  BEGIN
    IF (der_qtr < TO_DATE('01-APR', 'DD-MON')) THEN
      RETURN 'FIRST';
    ELSIF (der_qtr < TO_DATE('01-JUL', 'DD-MON')) THEN
      RETURN 'SECOND';
    ELSIF (der_qtr < TO_DATE('01-OCT', 'DD-MON')) THEN
      RETURN 'THIRD';
    ELSE
      RETURN 'FOURTH';
    END IF;
  END IF;
```

```
        END;  
    END;  
/
```

Example 14-8 Adding a Collection Attribute

This example adds the `author` attribute to the `textdoc_tab` object column of the `text` table.

```
CREATE TABLE text (  
    doc_id          NUMBER,  
    description     textdoc_tab)  
    NESTED TABLE description STORE AS text_store;  
  
ALTER TYPE textdoc_typ  
    ADD ATTRIBUTE (author VARCHAR2) CASCADE;
```

The `CASCADE` keyword is required because both the `textdoc_tab` and `text` table are dependent on the `textdoc_typ` type.

Example 14-9 Increasing the Number of Elements of a Collection Type

This example increases the maximum number of elements in the varray `phone_list_typ_demo`.

```
ALTER TYPE phone_list_typ_demo  
    MODIFY LIMIT 10 CASCADE;
```

Example 14-10 Increasing the Length of a Collection Type

This example increases the length of the varray element type `phone_list_typ`.

```
ALTER TYPE phone_list_typ  
    MODIFY ELEMENT TYPE VARCHAR(64) CASCADE;
```

Example 14-11 Recompiling a Type

This example recompiles type `cust_address_typ` in the `hr` schema.

```
ALTER TYPE cust_address_typ2 COMPILE;
```

Example 14-12 Recompiling a Type Specification

This example compiles the type specification of `link2`.

```
CREATE TYPE link1 AS OBJECT  
    (a NUMBER);  
/  
CREATE TYPE link2 AS OBJECT  
    (a NUMBER,  
    b link1,  
    MEMBER FUNCTION p(c1 NUMBER) RETURN NUMBER);  
/  
CREATE TYPE BODY link2 AS  
    MEMBER FUNCTION p(c1 NUMBER) RETURN NUMBER IS  
        BEGIN  
            dbms_output.put_line(c1);  
            RETURN c1;  
        END;  
    END;  
/
```

In this example, both the specification and body of `link2` are invalidated because `link1`, which is an attribute of `link2`, is altered.

```
ALTER TYPE link1 ADD ATTRIBUTE (b NUMBER) INVALIDATE;
```

You must recompile the type by recompiling the specification and body in separate statements:

```
ALTER TYPE link2 COMPILE SPECIFICATION;
```

```
ALTER TYPE link2 COMPILE BODY;
```

Alternatively, you can compile both specification and body at the same time:

```
ALTER TYPE link2 COMPILE;
```

Example 14-13 Evolving and Resetting an ADT

This example creates an ADT in the schema `Usr`, evolves that ADT, and then tries to enable editions for `Usr`, which fails.

Then the example resets the version of the ADT to 1 and succeeds in enabling editions for `Usr`. To show the version numbers of the newly created, evolved, and reset ADT, the example uses the static data dictionary view `DBA_TYPE_VERSIONS`.

```
-- Create ADT in schema Usr:
create type Usr.My_ADT authid Definer is object(a1 number)
```

```
-- Show version number of ADT:
select Version#||Chr(10)||Text t
from DBA_Type_Versions
where Owner = 'USR'
and Type_Name = 'MY_ADT'
/
```

Result:

```
T
-----
1
type      My_ADT authid Definer is object(a1 number)
```

1 row selected.

```
-- Evolve ADT:
alter type Usr.My_ADT add attribute (a2 number)
/
```

```
-- Show version number of evolved ADT:
select Version#||Chr(10)||Text t
from DBA_Type_Versions
where Owner = 'USR'
and Type_Name = 'MY_ADT'
/
```

Result:

```
T
-----
1
```

```

type      My_ADT authid Definer is object(a1 number)

2
type      My_ADT authid Definer is object(a1 number)

2
alter type      My_ADT add attribute (a2 number)

```

3 rows selected.

```

-- Try to enable editions for Usr:
alter user Usr enable editions
/

```

Result:

```

alter user Usr enable editions
*
ERROR at line 1:
ORA-38820: user has evolved object type

```

```

-- Reset version of ADT to 1:
alter type Usr.My_ADT reset
/

```

```

-- Show version number of reset ADT:
select Version#||Chr(10)||Text t
from DBA_Type_Versions
where Owner = 'USR'
and Type_Name = 'MY_ADT'
/

```

Result:

```

T
-----
1
type      My_ADT authid Definer is object(a1 number)

1
alter type      My_ADT add attribute (a2 number)

```

2 rows selected.

```

-- Try to enable editions for Usr:
alter user Usr enable editions
/

```

Result:

User altered.

Related Topics

In this chapter:

- ["CREATE TYPE Statement"](#)
- ["CREATE TYPE BODY Statement"](#)

- ["DROP TYPE Statement"](#)

In other books:

- *Oracle Database Development Guide* for more information about editions
- *Oracle Database Development Guide* for more information about pragmas
- *Oracle Database Object-Relational Developer's Guide* for more information about the implications of not including table data when modifying type attribute

14.7 CREATE FUNCTION Statement

The `CREATE FUNCTION` statement creates or replaces a standalone function or a call specification.

A **standalone function** is a function (a subprogram that returns a single value) that is stored in the database.

Note:

A standalone function that you create with the `CREATE FUNCTION` statement differs from a function that you declare and define in a PL/SQL block or package. For more information, see ["Function Declaration and Definition"](#) and [CREATE PACKAGE Statement](#).

A **call specification** declares a Java method or a C function so that it can be invoked from PL/SQL. You can also use the `SQL CALL` statement to invoke such a method or subprogram. The call specification tells the database which Java method, or which named function in which shared library, to invoke when an invocation is made. It also tells the database what type conversions to make for the arguments and return value.

Note:

To be callable from SQL statements, a stored function must obey certain rules that control side effects. See ["Subprogram Side Effects"](#).

Topics

- [Prerequisites](#)
- [Syntax](#)
- [Semantics](#)
- [Examples](#)
- [Related Topics](#)

Prerequisites

To create or replace a standalone function in your schema, you must have the `CREATE PROCEDURE` system privilege.

To create or replace a standalone function in another user's schema, you must have the `CREATE ANY PROCEDURE` system privilege.

To invoke a call specification, you may need additional privileges, for example, `EXECUTE` privileges on a C library for a C call specification.

To embed a `CREATE FUNCTION` statement inside an Oracle precompiler program, you must terminate the statement with the keyword `END-EXEC` followed by the embedded SQL statement terminator for the specific language.

See Also:

For more information about such prerequisites:

- *Oracle Database Development Guide*
- *Oracle Database Java Developer's Guide*

Syntax

`create_function ::=`

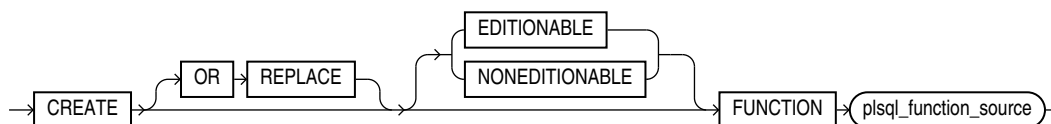

plsql_function_source ::=

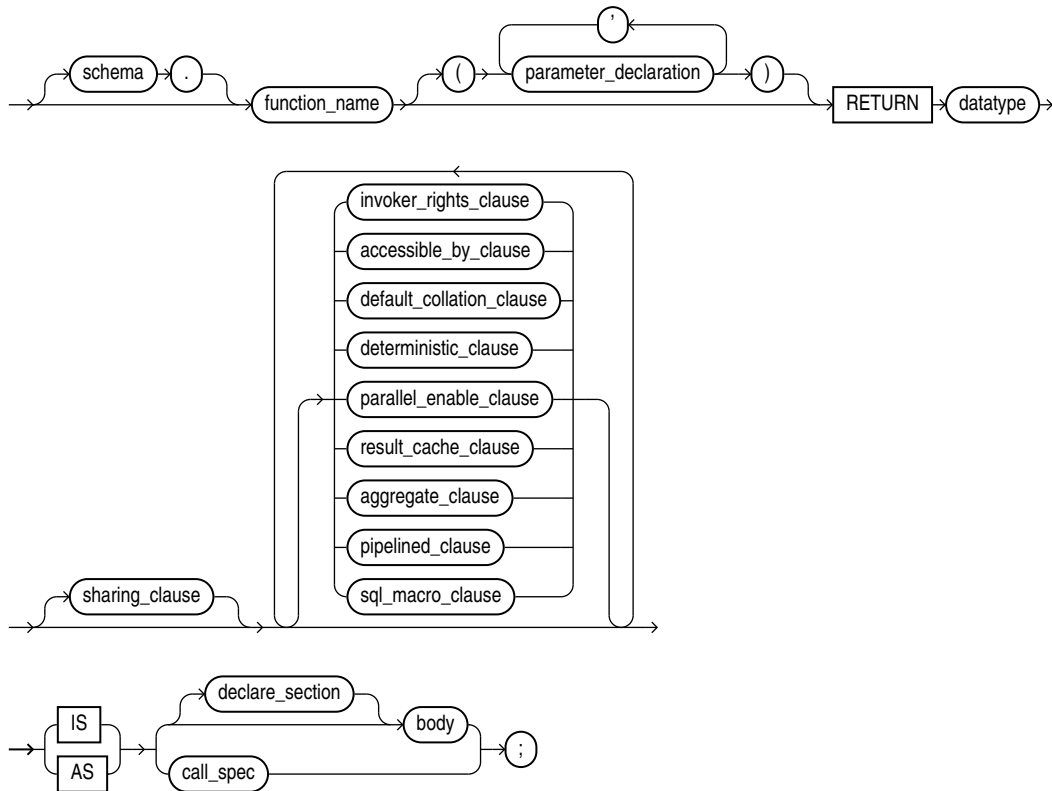

(*sharing_clause ::=* , *invoker_rights_clause ::=* , *accessible_by_clause ::=* ,
default_collation_clause ::= , *deterministic_clause ::=* , *parallel_enable_clause ::=* ,
result_cache_clause ::= , *aggregate_clause ::=* , *pipelined_clause ::=* , *sql_macro_clause ::=* ,
body ::= , *call_spec ::=* , *datatype ::=* , *declare_section ::=* , *parameter_declaration ::=*)

Semantics

create_function

OR REPLACE

Re-creates the function if it exists, and recompiles it.

Users who were granted privileges on the function before it was redefined can still access the function without being regranted the privileges.

If any function-based indexes depend on the function, then the database marks the indexes DISABLED.

[EDITIONABLE | NONEDITIONABLE]

Specifies whether the function is an editioned or noneditioned object if editioning is enabled for the schema object type FUNCTION in *schema*. **Default:** EDITIONABLE. For information about editioned and noneditioned objects, see *Oracle Database Development Guide*.

plsql_function_source**schema**

Name of the schema containing the function. **Default:** your schema.

function_name

Name of the function to be created.

 **Note:**

If you plan to invoke a stored subprogram using a stub generated by SQL*Module, then the stored subprogram name must also be a legal identifier in the invoking host 3GL language, such as Ada or C.

RETURN datatype

For *datatype*, specify the data type of the return value of the function. The return value can have any data type supported by PL/SQL.

 **Note:**

Oracle SQL does not support invoking functions with `BOOLEAN` parameters or returns. Therefore, for SQL statements to invoke your user-defined functions, you must design them to return numbers (0 or 1) or character strings ('TRUE' or 'FALSE').

The data type cannot specify a length, precision, or scale. The database derives the length, precision, or scale of the return value from the environment from which the function is called.

If the return type is `ANYDATASET` and you intend to use the function in the `FROM` clause of a query, then you must also specify the `PIPELINED` clause and define a describe method (`ODCItableDescribe`) as part of the implementation type of the function.

You cannot constrain this data type (with `NOT NULL`, for example).

body

The required executable part of the function and, optionally, the exception-handling part of the function.

declare_section

The optional declarative part of the function. Declarations are local to the function, can be referenced in *body*, and cease to exist when the function completes execution.

Examples**Example 14-14 Creating a Function**

This statement creates the function `get_bal` on the sample table `oe.orders`.

```

CREATE FUNCTION get_bal(acc_no IN NUMBER)
  RETURN NUMBER
  IS acc_bal NUMBER(11,2);
BEGIN
  SELECT order_total
  INTO acc_bal
  FROM orders
  WHERE customer_id = acc_no;
  RETURN(acc_bal);
END;
/

```

The `get_bal` function returns the balance of a specified account.

When you invoke the function, you must specify the argument `acc_no`, the number of the account whose balance is sought. The data type of `acc_no` is `NUMBER`.

The function returns the account balance. The `RETURN` clause of the `CREATE FUNCTION` statement specifies the data type of the return value to be `NUMBER`.

The function uses a `SELECT` statement to select the `balance` column from the row identified by the argument `acc_no` in the `orders` table. The function uses a `RETURN` statement to return this value to the environment in which the function is called.

The function created in the preceding example can be used in a SQL statement. For example:

```

SELECT get_bal(165) FROM DUAL;

GET_BAL(165)
-----
          2519

```

Example 14-15 Creating Aggregate Functions

The next statement creates an aggregate function called `SecondMax` to aggregate over number values. It assumes that the ADT `SecondMaxImpl` subprograms contains the implementations of the `ODCIAggregate` subprograms:

```

CREATE FUNCTION SecondMax (input NUMBER) RETURN NUMBER
  PARALLEL_ENABLE AGGREGATE USING SecondMaxImpl;

```

See Also:

Oracle Database Data Cartridge Developer's Guide for the complete implementation of type and type body for `SecondMaxImpl`

Use such an aggregate function in a query like this statement, which queries the sample table `hr.employees`:

```

SELECT SecondMax(salary) "SecondMax", department_id
  FROM employees
  GROUP BY department_id
  HAVING SecondMax(salary) > 9000
  ORDER BY "SecondMax", department_id;

SecondMax DEPARTMENT_ID

```

```
-----  
          9450          100  
13670.74          50  
          14175          80  
18742.5           90
```

Example 14-16 Package Procedure in a Function

This statement creates a function that uses a `DBMS_LOB.GETLENGTH` procedure to return the length of a `CLOB` column.

```
CREATE OR REPLACE FUNCTION text_length(a CLOB)  
  RETURN NUMBER DETERMINISTIC IS  
BEGIN  
  RETURN DBMS_LOB.GETLENGTH(a);  
END;
```

Related Topics

In this chapter:

- ["ALTER FUNCTION Statement"](#)
- ["CREATE PROCEDURE Statement"](#)
- ["DROP FUNCTION Statement"](#)

In other chapters:

- [Overview of Polymorphic Table Functions](#)
- ["Function Declaration and Definition"](#) for information about creating a function in a PL/SQL block
- ["Formal Parameter Declaration"](#)
- ["PL/SQL Subprograms"](#)

In other books:

- *Oracle Database SQL Language Reference* for information about the `CALL` statement
- *Oracle Database Development Guide* for information about restrictions on user-defined functions that are called from SQL statements
- *Oracle Database Development Guide* for more information about call specifications
- *Oracle Database Data Cartridge Developer's Guide* for information about defining the `ODCItableDescribe` function

14.8 CREATE LIBRARY Statement

The `CREATE LIBRARY` statement creates a **library**, which is a schema object associated with an operating-system shared library.

 **Note:**

The `CREATE LIBRARY` statement is valid only on platforms that support shared libraries and dynamic linking.

For instructions for creating an operating-system shared library, or DLL, see *Oracle Database Development Guide*.

You can use the name of the library schema object in the `call_spec` of `CREATE FUNCTION` or `CREATE PROCEDURE` statements, or when declaring a function or procedure in a package or type, so that SQL and PL/SQL can invoke third-generation-language (3GL) functions and procedures.

Topics

- [Prerequisites](#)
- [Syntax](#)
- [Semantics](#)
- [Examples](#)
- [Related Topics](#)

Prerequisites

To create a library in your schema, you must have the `CREATE LIBRARY` system privilege. To create a library in another user's schema, you must have the `CREATE ANY LIBRARY` system privilege.

To create a library that is associated with a DLL in a directory object, you must have the `EXECUTE` object privilege on the directory object.

To create a library that is associated with a credential name, you must have the `EXECUTE` object privilege on the credential name.

To use the library in the `call_spec` of a `CREATE FUNCTION` statement, or when declaring a function in a package or type, you must have the `EXECUTE` object privilege on the library and the `CREATE FUNCTION` system privilege.

To use the library in the `call_spec` of a `CREATE PROCEDURE` statement, or when declaring a procedure in a package or type, you must have the `EXECUTE` object privilege on the library and the `CREATE PROCEDURE` system privilege.

To execute a procedure or function defined with the `call_spec` (including a procedure or function defined within a package or type), you must have the `EXECUTE` object privilege on the procedure or function (but you do not need the `EXECUTE` object privilege on the library).

Syntax

create_library ::=

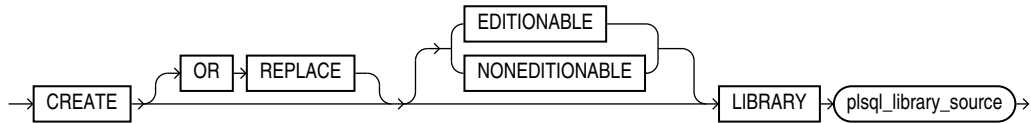

plsql_library_source ::=

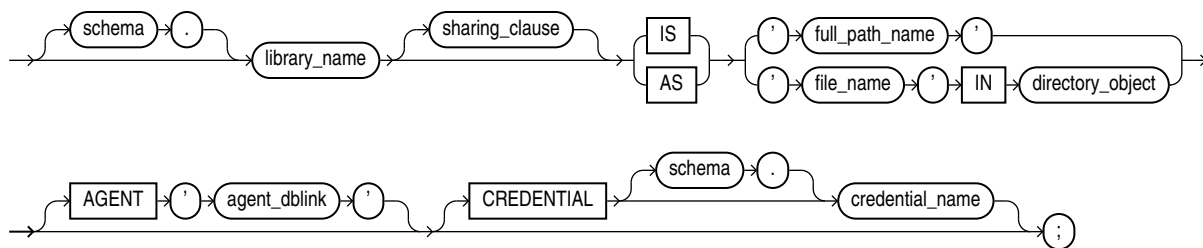

(sharing_clause ::=)

Semantics

create_library

OR REPLACE

Re-creates the library if it exists, and recompiles it.

Users who were granted privileges on the library before it was redefined can still access it without being regranted the privileges.

[EDITIONABLE | NONEDITIONABLE]

Specifies whether the library is an editioned or noneditioned object if editioning is enabled for the schema object type `LIBRARY` in `schema`. **Default:** `EDITIONABLE`. For information about editioned and noneditioned objects, see *Oracle Database Development Guide*.

plsql_library_source

schema

Name of the schema containing the library. **Default:** your schema.

library_name

Name that represents this library when a user declares a function or procedure with a `call_spec`.

'full_path_name'

String literal enclosed in single quotation marks, whose value your operating system recognizes as the full path name of a shared library.

The *full_path_name* is not interpreted during execution of the CREATE LIBRARY statement. The existence of the shared library is checked when someone invokes one of its subprograms.

'file_name' IN directory_object

The *file_name* is a string literal enclosed in single quotation marks, whose value is the name of a dynamic link library (DLL) in *directory_object*. The string literal cannot exceed 2,000 bytes and cannot contain path delimiters. The compiler ignores *file_name*, but at run time, *file_name* is checked for path delimiters.

directory_object

The *directory_object* is a directory object, created with the CREATE DIRECTORY statement (described in *Oracle Database SQL Language Reference*). If *directory_object* does not exist or you do not have the EXECUTE object privilege on *directory_object*, then the library is created with errors. If *directory_object* is subsequently created, then the library becomes invalid. Other reasons that the library can become invalid are:

- *directory_object* is dropped.
- *directory_object* becomes invalid.
- Your EXECUTE object privilege on *directory_object* is revoked.

If you create a library object in a PDB that has a predefined `PATH_PREFIX`, the library must use a directory object. The directory object will enforce the rules of `PATH_PREFIX` for the library object. Failure to use a directory object in the library object will raise a compilation error.

If a database is plugged into a CDB as a PDB with a predefined `PATH_PREFIX`, attempts to use a library object that does not use a directory object result in an ORA-65394 error. The library object will not be invalidated, but to make it usable, you must recreate it using a directory object. See *Oracle Multitenant Administrator's Guide* for more information about CDB administration.

AGENT 'agent_dblink'

Causes external procedures to run from a database link other than the server. Oracle Database uses the database link that *agent_dblink* specifies to run external procedures. If you omit this clause, then the default agent on the server (`extproc`) runs external procedures.

CREDENTIAL [schema.]credential_name

Specifies the credentials of the operating system user that the `extproc` agent impersonates when running an external subprogram that specifies the library. **Default:** Owner of the Oracle Database installation.

If *credential_name* does not exist or you do not have the EXECUTE object privilege on *credential_name*, then the library is created with errors. If *credential_name* is subsequently created, then the library becomes invalid. Other reasons that the library can become invalid are:

- *credential_name* is dropped.
- *credential_name* becomes invalid.

- Your EXECUTE object privilege on *credential_name* is revoked.

For information about using credentials, see *Oracle Database Security Guide*.

Examples

Example 14-17 Creating a Library

The following statement creates library *ext_lib*, using a directory object:

```
CREATE LIBRARY ext_lib AS 'ddl_1' IN ddl_dir;  
/
```

The following statement re-creates library *ext_lib*, using a directory object and a credential:

```
CREATE OR REPLACE LIBRARY ext_lib AS 'ddl_1' IN ddl_dir CREDENTIAL ddl_cred;  
/
```

The following statement creates library *ext_lib*, using an explicit path:

```
CREATE LIBRARY ext_lib AS '/OR/lib/ext_lib.so';  
/
```

The following statement re-creates library *ext_lib*, using an explicit path:

```
CREATE OR REPLACE LIBRARY ext_lib IS '/OR/newlib/ext_lib.so';  
/
```

Example 14-18 Specifying an External Procedure Agent

The following example creates a library *app_lib* (using an explicit path) and specifies that external procedures run from the public database *sales.hq.example.com*:

```
CREATE LIBRARY app_lib as '${ORACLE_HOME}/lib/app_lib.so'  
AGENT 'sales.hq.example.com';  
/
```

See Also:

Oracle Database SQL Language Reference for information about creating database links

Related Topics

- ["ALTER LIBRARY Statement"](#)
- ["DROP LIBRARY Statement"](#)
- ["CREATE FUNCTION Statement"](#)
- ["CREATE PROCEDURE Statement"](#)

14.9 CREATE PACKAGE Statement

The `CREATE PACKAGE` statement creates or replaces the specification for a stored **package**, which is an encapsulated collection of related procedures, functions, and other program objects stored as a unit in the database.

The **package specification** declares these objects. The **package body**, specified subsequently, defines these objects.

Topics

- [Prerequisites](#)
- [Syntax](#)
- [Semantics](#)
- [Example](#)
- [Related Topics](#)

Prerequisites

To create or replace a package in your schema, you must have the `CREATE PROCEDURE` system privilege. To create or replace a package in another user's schema, you must have the `CREATE ANY PROCEDURE` system privilege.

To embed a `CREATE PACKAGE` statement inside an Oracle database precompiler program, you must terminate the statement with the keyword `END-EXEC` followed by the embedded SQL statement terminator for the specific language.

Syntax

`create_package ::=`

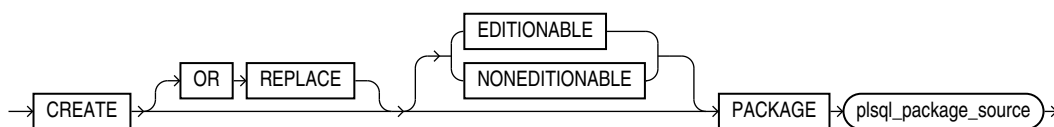

`plsql_package_source ::=`

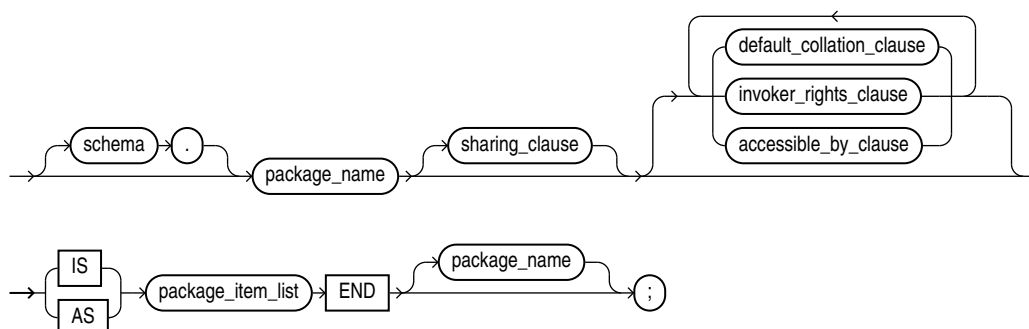

(*sharing_clause* ::= , *default_collation_clause* ::= , *invoker_rights_clause* ::= ,
accessible_by_clause ::= ,)

package_item_list ::=

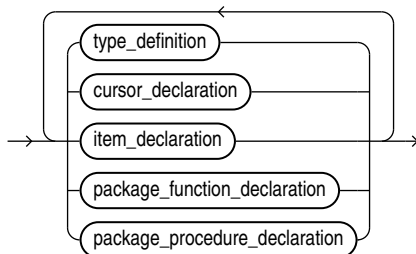

(*cursor_declaration* ::= , *item_declaration* ::= , *type_definition* ::=)

package_function_declaration ::=

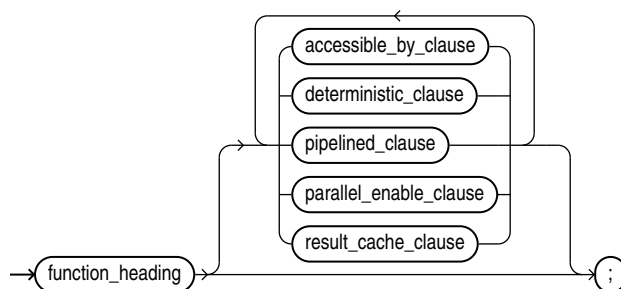

(*function_heading* ::= , *accessible_by_clause* ::= , *deterministic_clause* ::= ,
pipelined_clause ::= , *parallel_enable_clause* ::= , *result_cache_clause* ::=)

package_procedure_declaration ::=

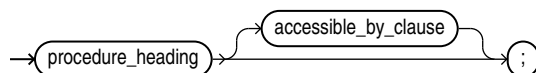

(*procedure_heading* ::= , *accessible_by_clause* ::=)

Semantics

create_package

OR REPLACE

Re-creates the package if it exists, and recompiles it.

Users who were granted privileges on the package before it was redefined can still access the package without being regranted the privileges.

If any function-based indexes depend on the package, then the database marks the indexes DISABLED.

[EDITIONABLE | NONEDITIONABLE]

Specifies whether the package is an editioned or noneditioned object if editioning is enabled for the schema object type `PACKAGE` in *schema*. **Default:** `EDITIONABLE`. For information about editioned and noneditioned objects, see *Oracle Database Development Guide*.

plsql_package_source

schema

Name of the schema containing the package. **Default:** your schema.

package_name

A package stored in the database. For naming conventions, see "[Identifiers](#)".

package_item_list

Defines every type in the package and declares every cursor and subprogram in the package. Except for polymorphic table functions, every declaration must have a corresponding definition in the package body. The headings of corresponding declarations and definitions must match word for word, except for white space. Package polymorphic table function must be declared in the same package as their implementation package.

Restriction on package_item_list

`PRAGMA AUTONOMOUS_TRANSACTION` cannot appear here.

Example

Example 14-19 Creating the Specification for the emp_mgmt Package

This statement creates the specification of the `emp_mgmt` package.

```
CREATE OR REPLACE PACKAGE emp_mgmt AS
    FUNCTION hire (last_name VARCHAR2, job_id VARCHAR2,
        manager_id NUMBER, salary NUMBER,
        commission_pct NUMBER, department_id NUMBER)
        RETURN NUMBER;
    FUNCTION create_dept(department_id NUMBER, location_id NUMBER)
        RETURN NUMBER;
    PROCEDURE remove_emp(employee_id NUMBER);
    PROCEDURE remove_dept(department_id NUMBER);
    PROCEDURE increase_sal(employee_id NUMBER, salary_incr NUMBER);
    PROCEDURE increase_comm(employee_id NUMBER, comm_incr NUMBER);
    no_comm EXCEPTION;
    no_sal EXCEPTION;
END emp_mgmt;
```

The specification for the `emp_mgmt` package declares these public program objects:

- The functions `hire` and `create_dept`
- The procedures `remove_emp`, `remove_dept`, `increase_sal`, and `increase_comm`
- The exceptions `no_comm` and `no_sal`

All of these objects are available to users who have access to the package. After creating the package, you can develop applications that invoke any of these public procedures or functions or raise any of the public exceptions of the package.

Before you can invoke this package's procedures and functions, you must define these procedures and functions in the package body. For an example of a `CREATE PACKAGE BODY` statement that creates the body of the `emp_mgmt` package, see "[CREATE PACKAGE BODY Statement](#)".

Related Topics

In this chapter:

- "[ALTER PACKAGE Statement](#)"
- "[CREATE PACKAGE Statement](#)"
- "[CREATE PACKAGE BODY Statement](#)"
- "[DROP PACKAGE Statement](#)"

In other chapters:

- "[PL/SQL Packages](#)"
- "[Package Specification](#)"
- "[Function Declaration and Definition](#)"
- "[Procedure Declaration and Definition](#)"

14.10 CREATE PACKAGE BODY Statement

The `CREATE PACKAGE BODY` statement creates or replaces the body of a stored **package**, which is an encapsulated collection of related procedures, stored functions, and other program objects stored as a unit in the database.

The **package body** defines these objects. The **package specification**, defined in an earlier `CREATE PACKAGE` statement, declares these objects.

Packages are an alternative to creating procedures and functions as standalone schema objects.

Topics

- [Prerequisites](#)
- [Syntax](#)
- [Semantics](#)
- [Examples](#)
- [Related Topics](#)

Prerequisites

To create or replace a package in your schema, you must have the `CREATE PROCEDURE` system privilege. To create or replace a package in another user's schema, you must have the `CREATE ANY PROCEDURE` system privilege. In both cases, the package body must be created in the same schema as the package.

To embed a `CREATE PACKAGE BODY` statement inside an the database precompiler program, you must terminate the statement with the keyword `END-EXEC` followed by the embedded SQL statement terminator for the specific language.

Syntax

create_package_body ::=

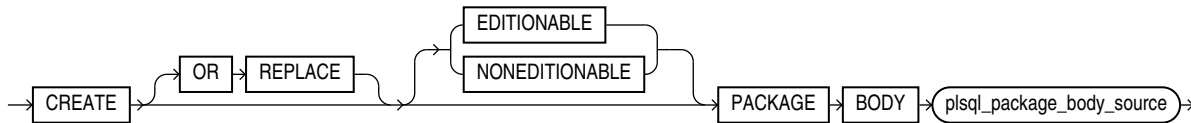

plsql_package_body_source ::=

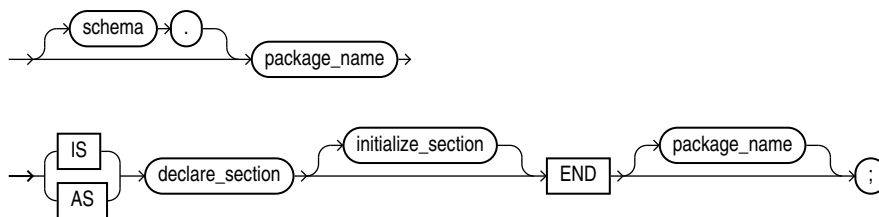

(*declare_section ::=*)

initialize_section ::=

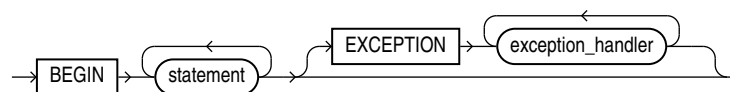

(*statement ::=* , *exception_handler ::=*)

Semantics

create_package_body

OR REPLACE

Re-creates the package body if it exists, and recompiles it.

Users who were granted privileges on the package body before it was redefined can still access the package without being regranted the privileges.

[EDITIONABLE | NONEDITIONABLE]

If you do not specify this property, then the package body inherits `EDITIONABLE` or `NONEDITIONABLE` from the package specification. If you do specify this property, then it must match that of the package specification.

plsql_package_body_source***schema***

Name of the schema containing the package. **Default:** your schema.

package_name

Name of the package to be created.

declare_section

Has a definition for every cursor and subprogram declaration in the package specification. The headings of corresponding subprogram declarations and definitions must match word for word, except for white space.

Can also declare and define private items that can be referenced only from inside the package.

Restriction on *declare_section*

PRAGMA AUTONOMOUS_TRANSACTION cannot appear here.

initialize_section

Initializes variables and does any other one-time setup steps.

Examples**Example 14-20 Creating the emp_mgmt Package Body**

This statement creates the body of the emp_mgmt package created in "[Example 14-19](#)".

```
CREATE OR REPLACE PACKAGE BODY emp_mgmt AS
    tot_emps NUMBER;
    tot_depts NUMBER;
    FUNCTION hire
        (last_name VARCHAR2, job_id VARCHAR2,
         manager_id NUMBER, salary NUMBER,
         commission_pct NUMBER, department_id NUMBER)
        RETURN NUMBER IS new_empno NUMBER;
    BEGIN
        SELECT employees_seq.NEXTVAL
           INTO new_empno
          FROM DUAL;
        INSERT INTO employees
           VALUES (new_empno, 'First', 'Last', 'first.example@example.com',
                  '(415)555-0100',
                  TO_DATE('18-JUN-2002', 'DD-MON-YYYY'),
                  'IT_PROG', 90000000, 00, 100, 110);
        tot_emps := tot_emps + 1;
        RETURN(new_empno);
    END;
    FUNCTION create_dept(department_id NUMBER, location_id NUMBER)
        RETURN NUMBER IS
        new_deptno NUMBER;
    BEGIN
        SELECT departments_seq.NEXTVAL
           INTO new_deptno
          FROM dual;
        INSERT INTO departments
```

```

        VALUES (new_deptno, 'department name', 100, 1700);
        tot_depts := tot_depts + 1;
        RETURN(new_deptno);
    END;
PROCEDURE remove_emp (employee_id NUMBER) IS
    BEGIN
        DELETE FROM employees
        WHERE employees.employee_id = remove_emp.employee_id;
        tot_emps := tot_emps - 1;
    END;
PROCEDURE remove_dept(department_id NUMBER) IS
    BEGIN
        DELETE FROM departments
        WHERE departments.department_id = remove_dept.department_id;
        tot_depts := tot_depts - 1;
        SELECT COUNT(*) INTO tot_emps FROM employees;
    END;
PROCEDURE increase_sal(employee_id NUMBER, salary_incr NUMBER) IS
    curr_sal NUMBER;
    BEGIN
        SELECT salary INTO curr_sal FROM employees
        WHERE employees.employee_id = increase_sal.employee_id;
        IF curr_sal IS NULL
            THEN RAISE no_sal;
        ELSE
            UPDATE employees
            SET salary = salary + salary_incr
            WHERE employee_id = employee_id;
        END IF;
    END;
PROCEDURE increase_comm(employee_id NUMBER, comm_incr NUMBER) IS
    curr_comm NUMBER;
    BEGIN
        SELECT commission_pct
        INTO curr_comm
        FROM employees
        WHERE employees.employee_id = increase_comm.employee_id;
        IF curr_comm IS NULL
            THEN RAISE no_comm;
        ELSE
            UPDATE employees
            SET commission_pct = commission_pct + comm_incr;
        END IF;
    END;
END emp_mgmt;

```

The package body defines the public program objects declared in the package specification:

- The functions `hire` and `create_dept`
- The procedures `remove_emp`, `remove_dept`, `increase_sal`, and `increase_comm`

These objects are declared in the package specification, so they can be called by application programs, procedures, and functions outside the package. For example, if you have access to the package, you can create a procedure `increase_all_comms` separate from the `emp_mgmt` package that invokes the `increase_comm` procedure.

These objects are defined in the package body, so you can change their definitions without causing the database to invalidate dependent schema objects. For example, if you subsequently change the definition of `hire`, then the database need not recompile `increase_all_comms` before running it.

The package body in this example also declares private program objects, the variables `tot_emps` and `tot_depts`. These objects are declared in the package body rather than the package specification, so they are accessible to other objects in the package, but they are not accessible outside the package. For example, you cannot develop an application that explicitly changes the value of the variable `tot_depts`. However, the function `create_dept` is part of the package, so `create_dept` can change the value of `tot_depts`.

Related Topics

In this chapter:

- ["CREATE PACKAGE Statement"](#)

In other chapters:

- ["PL/SQL Packages"](#)
- ["Package Body"](#)
- ["Function Declaration and Definition"](#)
- ["Procedure Declaration and Definition"](#)

14.11 CREATE PROCEDURE Statement

The `CREATE PROCEDURE` statement creates or replaces a standalone procedure or a call specification.

A **standalone procedure** is a procedure (a subprogram that performs a specific action) that is stored in the database.



Note:

A standalone procedure that you create with the `CREATE PROCEDURE` statement differs from a procedure that you declare and define in a PL/SQL block or package. For information, see ["Procedure Declaration and Definition"](#) or ["CREATE PACKAGE Statement"](#).

A **call specification** declares a Java method or a C language procedure so that it can be called from PL/SQL. You can also use the SQL `CALL` statement to invoke such a method or subprogram. The call specification tells the database which Java method, or which named procedure in which shared library, to invoke when an invocation is made. It also tells the database what type conversions to make for the arguments and return value.

Topics

- [Prerequisites](#)
- [Syntax](#)
- [Semantics](#)
- [Examples](#)
- [Related Topics](#)

Prerequisites

To create or replace a standalone procedure in your schema, you must have the `CREATE PROCEDURE` system privilege. To create or replace a standalone procedure in another user's schema, you must have the `CREATE ANY PROCEDURE` system privilege.

To invoke a call specification, you may need additional privileges, for example, the `EXECUTE` object privilege on the C library for a C call specification.

To embed a `CREATE PROCEDURE` statement inside an Oracle precompiler program, you must terminate the statement with the keyword `END-EXEC` followed by the embedded SQL statement terminator for the specific language.

Syntax

create_procedure ::=

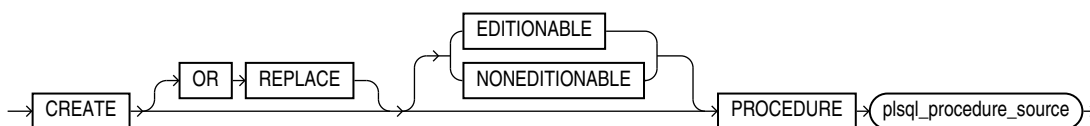

plsql_procedure_source ::=

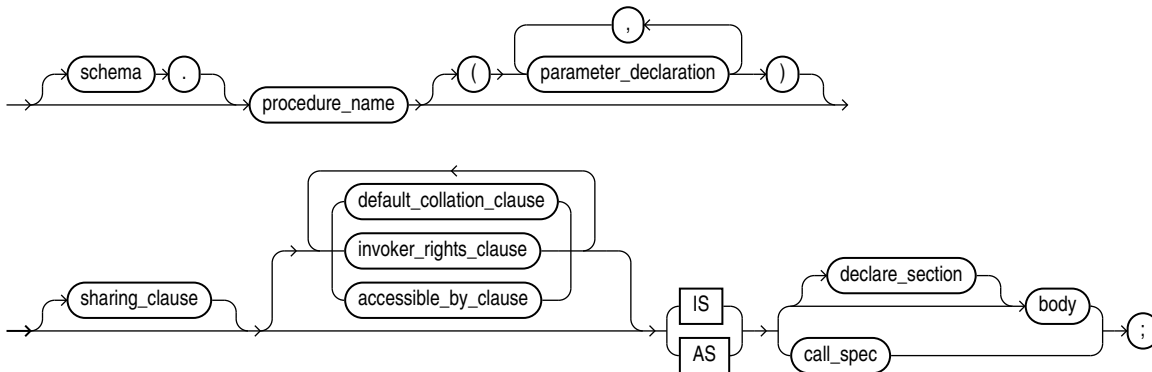

(*sharing_clause ::=*, *default_collation_clause ::=*, *invoker_rights_clause ::=*,
accessible_by_clause ::=, *call_spec ::=*, *body ::=*, *declare_section ::=*,
parameter_declaration ::=)

Semantics

create_procedure

OR REPLACE

Re-creates the procedure if it exists, and recompiles it.

Users who were granted privileges on the procedure before it was redefined can still access the procedure without being regranted the privileges.

If any function-based indexes depend on the procedure, then the database marks the indexes `DISABLED`.

[EDITIONABLE | NONEDITIONABLE]

Specifies whether the procedure is an editioned or noneditioned object if editioning is enabled for the schema object type `PROCEDURE` in *schema*. **Default:** `EDITIONABLE`. For information about editioned and noneditioned objects, see *Oracle Database Development Guide*.

plsql_procedure_source

schema

Name of the schema containing the procedure. **Default:** your schema.

procedure_name

Name of the procedure to be created.



Note:

If you plan to invoke a stored subprogram using a stub generated by SQL*Module, then the stored subprogram name must also be a legal identifier in the invoking host 3GL language, such as Ada or C.

body

The required executable part of the procedure and, optionally, the exception-handling part of the procedure.

declare_section

The optional declarative part of the procedure. Declarations are local to the procedure, can be referenced in *body*, and cease to exist when the procedure completes execution.

Examples

Example 14-21 Creating a Procedure

This statement creates the procedure `remove_emp` in the schema `hr`.

```
CREATE PROCEDURE remove_emp (employee_id NUMBER) AS
    tot_emps NUMBER;
BEGIN
    DELETE FROM employees
        WHERE employees.employee_id = remove_emp.employee_id;
    tot_emps := tot_emps - 1;
END;
/
```

The `remove_emp` procedure removes a specified employee. When you invoke the procedure, you must specify the `employee_id` of the employee to be removed.

The procedure uses a `DELETE` statement to remove from the `employees` table the row of `employee_id`.

**See Also:**

"[CREATE PACKAGE BODY Statement](#)" to see how to incorporate this procedure into a package

Example 14-22 Creating an External Procedure

In this example, external procedure `c_find_root` expects a pointer as a parameter. Procedure `find_root` passes the parameter by reference using the `BY REFERENCE` phrase.

```
CREATE PROCEDURE find_root
  ( x IN REAL )
  IS LANGUAGE C
  NAME c_find_root
  LIBRARY c_utils
  PARAMETERS ( x BY REFERENCE );
```

Related Topics

In this chapter:

- ["ALTER PROCEDURE Statement"](#)
- ["CREATE FUNCTION Statement"](#)
- ["DROP PROCEDURE Statement"](#)

In other chapters:

- ["Formal Parameter Declaration"](#)
- ["Procedure Declaration and Definition"](#)
- ["PL/SQL Subprograms"](#)

In other books:

- *Oracle Database SQL Language Reference* for information about the `CALL` statement
- *Oracle Database Development Guide* for more information about call specifications
- *Oracle Database Development Guide* for more information about invoking stored PL/SQL subprograms

14.12 CREATE TRIGGER Statement

The `CREATE TRIGGER` statement creates or replaces a **database trigger**, which is either of these:

- A stored PL/SQL block associated with a table, a view, a schema, or the database
- An anonymous PL/SQL block or an invocation of a procedure implemented in PL/SQL or Java

The database automatically runs a trigger when specified conditions occur.

Topics

- [Prerequisites](#)

- [Syntax](#)
- [Semantics](#)
- [Examples](#)
- [Related Topics](#)

Prerequisites

- To create a trigger in your schema on a table in your schema or on your schema (SCHEMA), you must have the CREATE TRIGGER system privilege.
- To create a trigger in any schema on a table in any schema, or on another user's schema (schema.SCHEMA), you must have the CREATE ANY TRIGGER system privilege.
- In addition to the preceding privileges, to create a trigger on DATABASE, you must have the ADMINISTER DATABASE TRIGGER system privilege.
- To create a trigger on a pluggable database (PDB), you must be connected to that PDB and have the ADMINISTER DATABASE TRIGGER system privilege. For information about PDBs, see *Oracle Database Administrator's Guide*.
- In addition to the preceding privileges, to create a crossedition trigger, you must be enabled for editions. For information about enabling editions for a user, see *Oracle Database Development Guide*.

If the trigger issues SQL statements or invokes procedures or functions, then the owner of the trigger must have the privileges necessary to perform these operations. These privileges must be granted directly to the owner rather than acquired through roles.

Syntax

create_trigger ::=

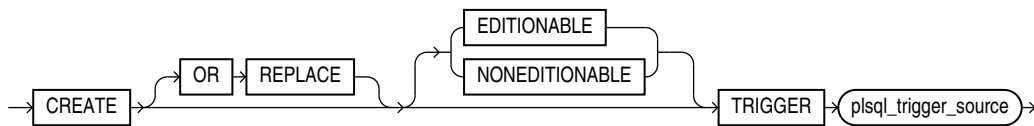

plsql_trigger_source ::=

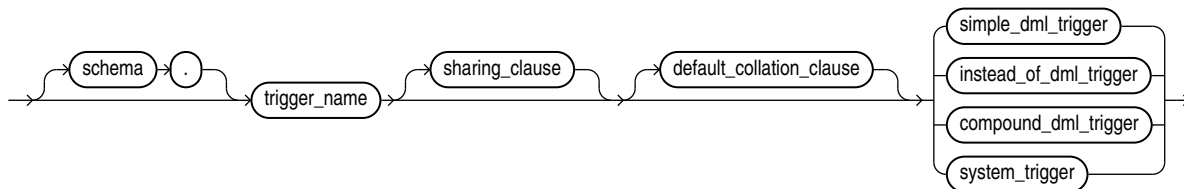

([sharing_clause ::=](#) , [default_collation_clause ::=](#) , [compound_dml_trigger ::=](#) ,
[instead_of_dml_trigger ::=](#) , [system_trigger ::=](#))

simple_dml_trigger ::=

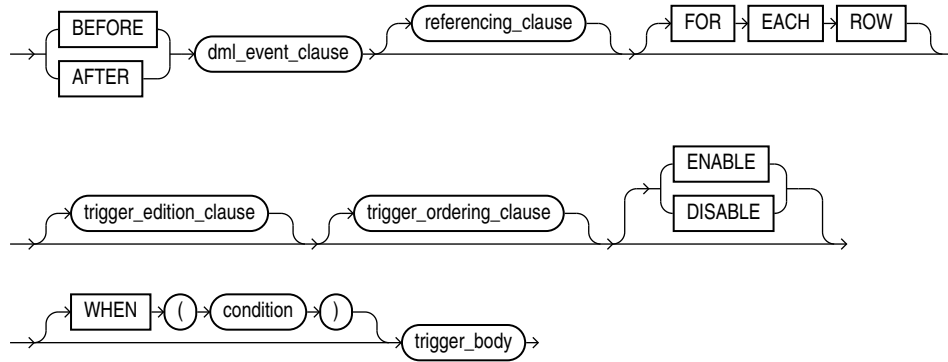

(*dml_event_clause* ::= , *referencing_clause* ::= , *trigger_body* ::= , *trigger_edition_clause* ::= , *trigger_ordering_clause* ::=)

instead_of_dml_trigger ::=

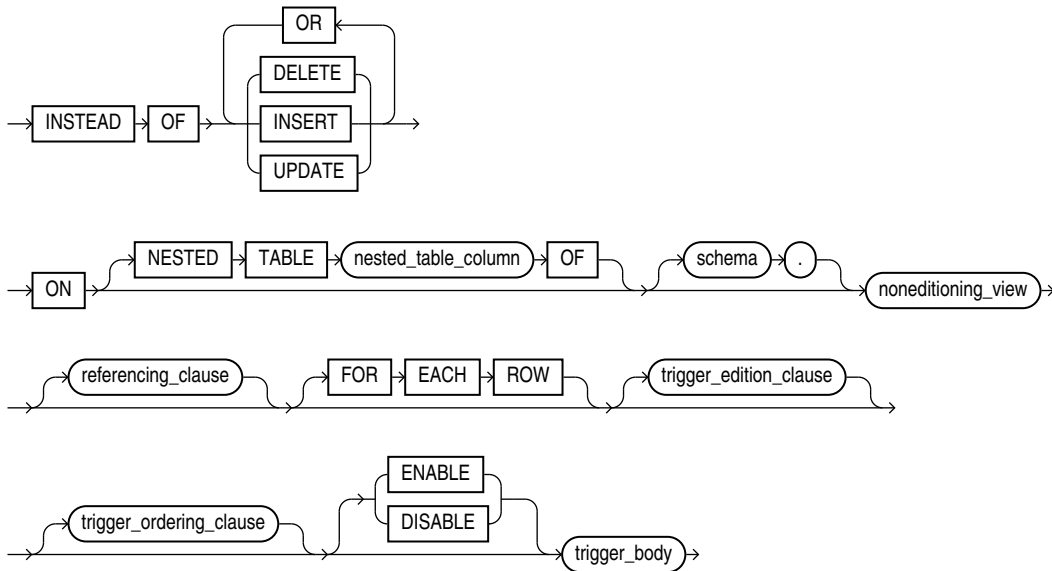

(*referencing_clause* ::= , *trigger_body* ::= , *trigger_edition_clause* ::= , *trigger_ordering_clause* ::=)

compound_dml_trigger ::=

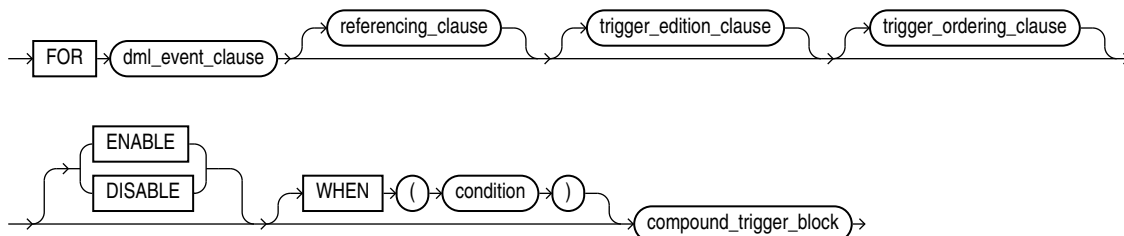

(*compound_trigger_block* ::= , *dml_event_clause* ::= , *referencing_clause* ::= ,
trigger_edition_clause ::= , *trigger_ordering_clause* ::=)

system_trigger ::=

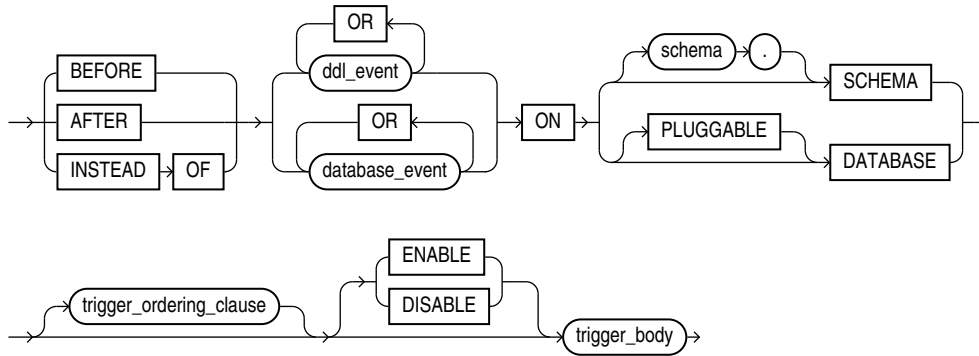

(*trigger_body* ::= , *trigger_ordering_clause* ::=)

dml_event_clause ::=

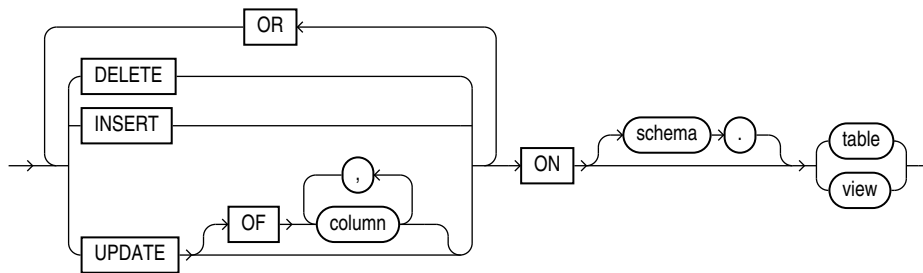

referencing_clause ::=

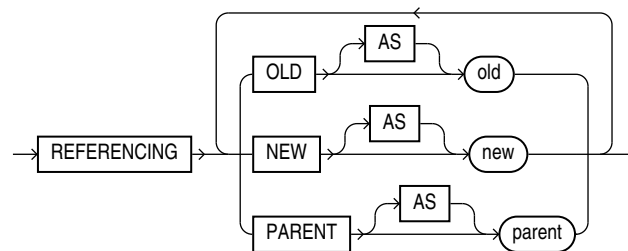

trigger_edition_clause ::=

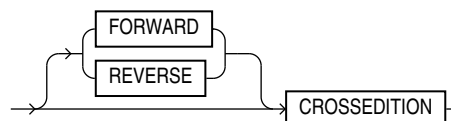

trigger_ordering_clause ::=

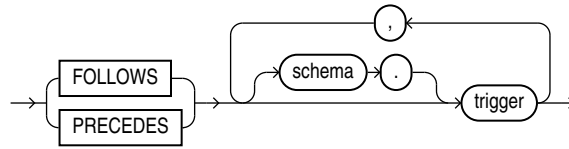

trigger_body ::=

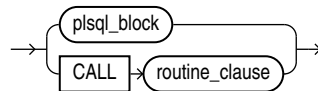

(*plsql_block* ::= ,

routine_clause in Oracle Database SQL Language Reference)

compound_trigger_block ::=

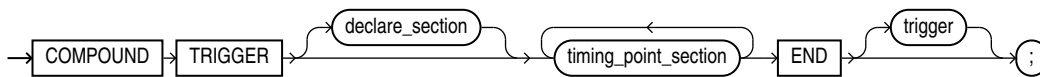

(*declare_section* ::=)

timing_point_section ::=

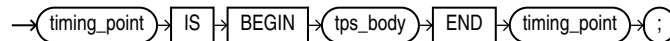

timing_point ::=

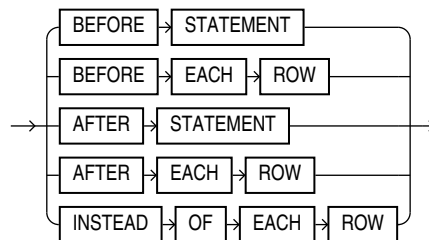

tps_body ::=

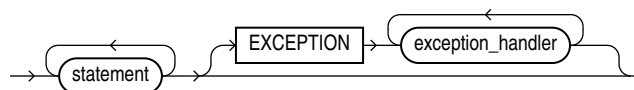

(*exception_handler* ::= , *statement* ::=)

Semantics

create_trigger

OR REPLACE

Re-creates the trigger if it exists, and recompiles it.

Users who were granted privileges on the trigger before it was redefined can still access the procedure without being regranted the privileges.

[**EDITIONABLE** | **NONEDITIONABLE**]

Specifies whether the trigger is an editioned or noneditioned object if editioning is enabled for the schema object type `TRIGGER` in *schema*. **Default:** `EDITIONABLE`. For information about editioned and noneditioned objects, see *Oracle Database Development Guide*.

Restriction on **NONEDITIONABLE**

You cannot specify `NONEDITIONABLE` for a crossedition trigger.

Restrictions on *create_trigger*

See "[Trigger Restrictions](#)".

plsql_trigger_source

schema

Name of the schema for the trigger to be created. **Default:** your schema.

trigger

Name of the trigger to be created.

Triggers in the same schema cannot have the same names. Triggers can have the same names as other schema objects—for example, a table and a trigger can have the same name—however, to avoid confusion, this is not recommended.

If a trigger produces compilation errors, then it is still created, but it fails on execution. A trigger that fails on execution effectively blocks all triggering DML statements until it is disabled, replaced by a version without compilation errors, or dropped. You can see the associated compiler error messages with the SQL*Plus command `SHOW ERRORS`.



Note:

If you create a trigger on a base table of a materialized view, then you must ensure that the trigger does not fire during a refresh of the materialized view. During refresh, the `DBMS_MVIEW` procedure `I_AM_A_REFRESH` returns `TRUE`.

simple_dml_trigger

Creates a simple DML trigger (described in "[DML Triggers](#)").

BEFORE

Causes the database to fire the trigger before running the triggering event. For row triggers, the trigger fires before each affected row is changed.

Restrictions on BEFORE

- You cannot specify a `BEFORE` trigger on a view unless it is an editing view.
- In a `BEFORE` statement trigger, the trigger body cannot read `:NEW` or `:OLD`. (In a `BEFORE` row trigger, the trigger body can read and write the `:OLD` and `:NEW` fields.)

AFTER

Causes the database to fire the trigger after running the triggering event. For row triggers, the trigger fires after each affected row is changed.

Restrictions on AFTER

- You cannot specify an `AFTER` trigger on a view unless it is an editing view.
- In an `AFTER` statement trigger, the trigger body cannot read `:NEW` or `:OLD`. (In an `AFTER` row trigger, the trigger body can read but not write the `:OLD` and `:NEW` fields.)

Note:

When you create a materialized view log for a table, the database implicitly creates an `AFTER` row trigger on the table. This trigger inserts a row into the materialized view log whenever an `INSERT`, `UPDATE`, or `DELETE` statement modifies data in the associated table. You cannot control the order in which multiple row triggers fire. Therefore, do not write triggers intended to affect the content of the materialized view.

See Also:

- *Oracle Database SQL Language Reference* for more information about materialized view logs
- *Oracle Database Development Guide* for information about editing views

FOR EACH ROW

Creates the trigger as a row trigger. The database fires a row trigger for each row that is affected by the triggering statement and meets the optional trigger constraint defined in the `WHEN` condition.

If you omit this clause, then the trigger is a statement trigger. The database fires a statement trigger only when the triggering statement is issued if the optional trigger constraint is met.

[ENABLE | DISABLE]

Creates the trigger in an enabled (default) or disabled state. Creating a trigger in a disabled state lets you ensure that the trigger compiles without errors before you enable it.

 **Note:**

DISABLE is especially useful if you are creating a crossedition trigger, which affects the online application being redefined if compilation errors occur.

WHEN (*condition*)

Specifies a SQL condition that the database evaluates for each row that the triggering statement affects. If the value of *condition* is TRUE for an affected row, then *trigger_body* runs for that row; otherwise, *trigger_body* does not run for that row. The triggering statement runs regardless of the value of *condition*.

The *condition* can contain correlation names (see "[referencing_clause ::=](#)").

In *condition*, do not put a colon (:) before the correlation name NEW, OLD, or PARENT (in this context, it is not a placeholder for a bind variable).

 **See Also:**

Oracle Database SQL Language Reference for information about SQL conditions

Restrictions on WHEN (*condition*)

- If you specify this clause, then you must also specify FOR EACH ROW.
- The *condition* cannot include a subquery or a PL/SQL expression (for example, an invocation of a user-defined function).

trigger_body

The PL/SQL block or CALL subprogram that the database runs to fire the trigger. A CALL subprogram is either a PL/SQL subprogram or a Java subprogram in a PL/SQL wrapper.

If *trigger_body* is a PL/SQL block and it contains errors, then the CREATE [OR REPLACE] statement fails.

Restriction on *trigger_body*

The *declare_section* cannot declare variables of the data type LONG or LONG RAW.

instead_of_dml_trigger

Creates an INSTEAD OF DML trigger (described in "[INSTEAD OF DML Triggers](#)").

Restriction on INSTEAD OF

An INSTEAD OF trigger can read the :OLD and :NEW values, but cannot change them.

 **Note:**

- If the view is inherently updatable and has `INSTEAD OF` triggers, the triggers take precedence: The database fires the triggers instead of performing DML on the view.
- If the view belongs to a hierarchy, then the subviews do not inherit the trigger.
- The `WITH CHECK OPTION` for views is not enforced when inserts or updates to the view are done using `INSTEAD OF` triggers. The `INSTEAD OF` trigger body must enforce the check. For information about `WITH CHECK OPTION`, see *Oracle Database SQL Language Reference*.
- The database fine-grained access control lets you define row-level security policies on views. These policies enforce specified rules in response to DML operations. If an `INSTEAD OF` trigger is also defined on the view, then the database does not enforce the row-level security policies, because the database fires the `INSTEAD OF` trigger instead of running the DML on the view.

DELETE

If the trigger is created on a nonconditioning view, then `DELETE` causes the database to fire the trigger whenever a `DELETE` statement removes a row from the table on which the nonconditioning view is defined.

If the trigger is created on a nested table column of a nonconditioning view, then `DELETE` causes the database to fire the trigger whenever a `DELETE` statement removes an element from the nested table.

INSERT

If the trigger is created on a nonconditioning view, then `INSERT` causes the database to fire the trigger whenever an `INSERT` statement adds a row to the table on which the nonconditioning view is defined.

If the trigger is created on a nested table column of a nonconditioning view, then `INSERT` causes the database to fire the trigger whenever an `INSERT` statement adds an element to the nested table.

UPDATE

If the trigger is created on a nonconditioning view, then `UPDATE` causes the database to fire the trigger whenever an `UPDATE` statement changes a value in a column of the table on which the nonconditioning view is defined.

If the trigger is created on a nested table column of a nonconditioning view, then `UPDATE` causes the database to fire the trigger whenever an `UPDATE` statement changes a value in a column of the nested table.

nested_table_column

Name of the *nested_table_column* on which the trigger is to be created. The trigger fires only if the DML operates on the elements of the nested table. Performing DML operations directly on nested table columns does not cause the database to fire triggers defined on the table containing the nested table column. For more information, see "[INSTEAD OF DML Triggers](#)".

 **See Also:**

AS *subquery* clause of CREATE VIEW in *Oracle Database SQL Language Reference* for a list of constructs that prevent inserts, updates, or deletes on a view

schema

Name of the schema containing the nonconditioning view. **Default:** your schema.

nonconditioning_view

If you specify *nested_table_column*, then *nonconditioning_view* is the name of the nonconditioning view that includes *nested_table_column*. Otherwise, *nonconditioning_view* is the name of the nonconditioning view on which the trigger is to be created.

FOR EACH ROW

For documentation only, because an INSTEAD OF trigger is always a row trigger.

ENABLE

(Default) Creates the trigger in an enabled state.

DISABLE

Creates the trigger in a disabled state, which lets you ensure that the trigger compiles without errors before you enable it.

 **Note:**

DISABLE is especially useful if you are creating a crossedition trigger, which affects the online application being redefined if compilation errors occur.

trigger_body

The PL/SQL block or CALL subprogram that the database runs to fire the trigger. A CALL subprogram is either a PL/SQL subprogram or a Java subprogram in a PL/SQL wrapper.

If *trigger_body* is a PL/SQL block and it contains errors, then the CREATE [OR REPLACE] statement fails.

Restriction on trigger_body

The *declare_section* cannot declare variables of the data type LONG or LONG RAW.

compound_dml_trigger

Creates a compound DML trigger (described in "[Compound DML Triggers](#)").

ENABLE

(Default) Creates the trigger in an enabled state.

DISABLE

Creates the trigger in a disabled state, which lets you ensure that the trigger compiles without errors before you enable it.

Note:

`DISABLE` is especially useful if you are creating a crossedition trigger, which affects the online application being redefined if compilation errors occur.

WHEN (*condition*)

Specifies a SQL condition that the database evaluates for each row that the triggering statement affects. If the value of *condition* is `TRUE` for an affected row, then *tps_body* runs for that row; otherwise, *tps_body* does not run for that row. The triggering statement runs regardless of the value of *condition*.

The *condition* can contain correlation names (see "[referencing_clause ::=](#)"). In *condition*, do not put a colon (:) before the correlation name `NEW`, `OLD`, or `PARENT` (in this context, it is not a placeholder for a bind variable).

See Also:

Oracle Database SQL Language Reference for information about SQL conditions

Restrictions on WHEN (*condition*)

- If you specify this clause, then you must also specify at least one of these timing points:
 - `BEFORE EACH ROW`
 - `AFTER EACH ROW`
 - `INSTEAD OF EACH ROW`
- The *condition* cannot include a subquery or a PL/SQL expression (for example, an invocation of a user-defined function).

system_trigger

Defines a system trigger (described in "[System Triggers](#)").

BEFORE

Causes the database to fire the trigger before running the triggering event.

AFTER

Causes the database to fire the trigger after running the triggering event.

INSTEAD OF

Creates an `INSTEAD OF` trigger.

Restrictions on INSTEAD OF

- The triggering event must be a `CREATE` statement.
- You can create at most one `INSTEAD OF DDL` trigger (*non_dml_trigger*).

For example, you can create an `INSTEAD OF` trigger on either the database or schema, but not on both the database and schema.

ddl_event

One or more types of DDL SQL statements that can cause the trigger to fire.

You can create triggers for these events on `DATABASE` or `SCHEMA` unless otherwise noted. You can create `BEFORE` and `AFTER` triggers for any of these events, but you can create `INSTEAD OF` triggers only for `CREATE` events. The database fires the trigger in the existing user transaction.

Note:

Some objects are created, altered, and dropped using PL/SQL APIs (for example, scheduler jobs are maintained by subprograms in the `DBMS_SCHEDULER` package). Such PL/SQL subprograms do not fire DDL triggers.

The following *ddl_event* values are valid:

- `ALTER`
Causes the database to fire the trigger whenever an `ALTER` statement modifies a database object in the data dictionary. An `ALTER DATABASE` statement does not fire the trigger.
- `ANALYZE`
Causes the database to fire the trigger whenever the database collects or deletes statistics or validates the structure of a database object.

See Also:

Oracle Database SQL Language Reference for information about using the SQL statement `ANALYZE` to collect statistics

- `ASSOCIATE STATISTICS`
Causes the database to fire the trigger whenever the database associates a statistics type with a database object.
- `AUDIT`
Causes the database to fire the trigger whenever an `AUDIT` statement is issued.
- `COMMENT`
Causes the database to fire the trigger whenever a comment on a database object is added to the data dictionary.
- `CREATE`

Causes the database to fire the trigger whenever a `CREATE` statement adds a database object to the data dictionary. The `CREATE DATABASE` or `CREATE CONTROLFILE` statement does not fire the trigger.

- `DISASSOCIATE STATISTICS`

Causes the database to fire the trigger whenever the database disassociates a statistics type from a database object.

- `DROP`

Causes the database to fire the trigger whenever a `DROP` statement removes a database object from the data dictionary.

- `GRANT`

Causes the database to fire the trigger whenever a user grants system privileges or roles or object privileges to another user or to a role.

- `NOAUDIT`

Causes the database to fire the trigger whenever a `NOAUDIT` statement is issued.

- `RENAME`

Causes the database to fire the trigger whenever a `RENAME` statement changes the name of a database object.

- `REVOKE`

Causes the database to fire the trigger whenever a `REVOKE` statement removes system privileges or roles or object privileges from a user or role.

- `TRUNCATE`

Causes the database to fire the trigger whenever a `TRUNCATE` statement removes the rows from a table or cluster and resets its storage characteristics.

- `DDL`

Causes the database to fire the trigger whenever any of the preceding DDL statements is issued.

database_event

One of the following database events. You can create triggers for these events on either `DATABASE` or `SCHEMA` unless otherwise noted. For each of these triggering events, the database opens an autonomous transaction scope, fires the trigger, and commits any separate transaction (regardless of any existing user transaction).

- `AFTER STARTUP`

Causes the database to fire the trigger whenever the database is opened. This event is valid only with `DATABASE`, not with `SCHEMA`.

- `BEFORE SHUTDOWN`

Causes the database to fire the trigger whenever an instance of the database is shut down. This event is valid only with `DATABASE`, not with `SCHEMA`.

- `AFTER DB_ROLE_CHANGE`

In an Oracle Data Guard configuration, causes the database to fire the trigger whenever a role change occurs from standby to primary or from primary to standby. This event is valid only with `DATABASE`, not with `SCHEMA`.

 **Note:**

You cannot create an `AFTER DB_ROLE_CHANGE` trigger on a PDB.

- `AFTER SERVERERROR`

Causes the database to fire the trigger whenever both of these conditions are true:

 - A server error message is logged.
 - Oracle relational database management system (RDBMS) determines that it is safe to fire error triggers.

Examples of when it is unsafe to fire error triggers include:

 - * RDBMS is starting up.
 - * A critical error has occurred.
- `AFTER LOGON`

Causes the database to fire the trigger whenever a client application logs onto the database.
- `BEFORE LOGOFF`

Causes the database to fire the trigger whenever a client application logs off the database.
- `AFTER SUSPEND`

Causes the database to fire the trigger whenever a server error causes a transaction to be suspended.
- `AFTER CLONE`

Can be specified only if `PLUGGABLE DATABASE` is specified. After the PDB is copied (cloned), the database fires the trigger in the new PDB and then deletes the trigger. If the trigger fails, then the copy operation fails.
- `BEFORE UNPLUG`

Can be specified only if `PLUGGABLE DATABASE` is specified. Before the PDB is unplugged, the database fires the trigger and then deletes it. If the trigger fails, then the unplug operation fails.
- `[BEFORE | AFTER] SET CONTAINER`

Causes the database to fire the trigger either before or after an `ALTER SESSION SET CONTAINER` statement executes.

 **See Also:**

"[Triggers for Publishing Events](#)" for more information about responding to database events through triggers

[*schema*.]SCHEMA

Defines the trigger on the specified schema. **Default:** current schema. The trigger fires whenever any user connected as the specified schema initiates the triggering event.

[PLUGGABLE] DATABASE

`DATABASE` defines the trigger on the root. In a multitenant container database (CDB), only a common user who is connected to the root can create a trigger on the entire database.

`PLUGGABLE DATABASE` defines the trigger on the PDB to which you are connected.

The trigger fires whenever any user of the specified database or PDB initiates the triggering event.

Note:

If you are connected to a PDB, then specifying `DATABASE` is equivalent to specifying `PLUGGABLE DATABASE` unless you want to specify an option that applies only to a PDB (such as `CLONE` or `UNPLUG`).

ENABLE

(Default) Creates the trigger in an enabled state.

DISABLE

Creates the trigger in a disabled state, which lets you ensure that the trigger compiles without errors before you enable it.

WHEN (*condition*)

Specifies a SQL condition that the database evaluates. If the value of *condition* is `TRUE`, then *trigger_body* runs for that row; otherwise, *trigger_body* does not run for that row. The triggering statement runs regardless of the value of *condition*.

See Also:

Oracle Database SQL Language Reference for information about SQL conditions

Restrictions on WHEN (*condition*)

- You cannot specify this clause for a `STARTUP`, `SHUTDOWN`, or `DB_ROLE_CHANGE` trigger.
- If you specify this clause for a `SERVERERROR` trigger, then *condition* must be `ERRNO = error_code`.
- The *condition* cannot include a subquery, a PL/SQL expression (for example, an invocation of a user-defined function), or a correlation name.

trigger_body

The PL/SQL block or `CALL` subprogram that the database runs to fire the trigger. A `CALL` subprogram is either a PL/SQL subprogram or a Java subprogram in a PL/SQL wrapper.

If *trigger_body* is a PL/SQL block and it contains errors, then the CREATE [OR REPLACE] statement fails.

Restrictions on *trigger_body*

- The *declare_section* cannot declare variables of the data type LONG or LONG RAW.
- The trigger body cannot specify either :NEW or :OLD.

dml_event_clause

Specifies the triggering statements for *simple_dml_trigger* or *compound_dml_trigger*. The database fires the trigger in the existing user transaction.

DELETE

Causes the database to fire the trigger whenever a DELETE statement removes a row from *table* or the table on which *view* is defined.

INSERT

Causes the database to fire the trigger whenever an INSERT statement adds a row to *table* or the table on which *view* is defined.

UPDATE [OF *column* [, *column*]]

Causes the database to fire the trigger whenever an UPDATE statement changes a value in a specified column. **Default:** The database fires the trigger whenever an UPDATE statement changes a value in any column of *table* or the table on which *view* is defined.

If you specify a *column*, then you cannot change its value in the body of the trigger.

schema

Name of the schema that contains the database object on which the trigger is to be created. **Default:** your schema.

table

Name of the database table or object table on which the trigger is to be created.

Restriction on *schema.table*

You cannot create a trigger on a table in the schema SYS.

view

Name of the database view or object view on which the trigger is to be created.



Note:

A compound DML trigger created on a nonconditioning view is not really compound, because it has only one timing point section.

referencing_clause

Specifies correlation names, which refer to old, new, and parent values of the current row.

Defaults: OLD, NEW, and PARENT.

If your trigger is associated with a table named OLD, NEW, or PARENT, then use this clause to specify different correlation names to avoid confusion between the table names and the correlation names.

If the trigger is defined on a nested table, then OLD and NEW refer to the current row of the nested table, and PARENT refers to the current row of the parent table. If the trigger is defined on a database table or view, then OLD and NEW refer to the current row of the database table or view, and PARENT is undefined.

Restriction on *referencing_clause*

The *referencing_clause* is not valid if *trigger_body* is CALL routine.

DML row-level triggers cannot reference fields of OLD/NEW/PARENT pseudorecords (correlation names) that correspond to columns with declared collation other than USING_NLS_COMP.

trigger_edition_clause

Creates the trigger as a crossedition trigger.

The handling of DML changes during edition-based redefinition (EBR) of an online application can entail multiple steps. Therefore, it is likely, though not required, that a crossedition trigger is also a **compound trigger**.

Restrictions on *trigger_edition_clause*

- You cannot define a crossedition trigger on a view.
- You cannot specify NONEDITIONABLE for a crossedition trigger.

FORWARD

(Default) Creates the trigger as a forward crossedition trigger. A forward crossedition trigger is intended to fire when DML changes are made in a database while an online application that uses the database is being patched or upgraded with EBR. The body of a crossedition trigger is designed to handle these DML changes so that they can be appropriately applied after the changes to the application code are completed.

REVERSE

Creates the trigger as a reverse crossedition trigger, which is intended to fire when the application, after being patched or upgraded with EBR, makes DML changes. This trigger propagates data to columns or tables used by the application before it was patched or upgraded.



See Also:

Oracle Database Development Guide for more information crossedition triggers

trigger_ordering_clause

FOLLOWS | PRECEDES

Specifies the relative firing of triggers that have the same timing point. It is especially useful when creating crossedition triggers, which must fire in a specific order to achieve their purpose.

Use `FOLLOWS` to indicate that the trigger being created must fire after the specified triggers. You can specify `FOLLOWS` for a conventional trigger or for a forward crossedition trigger.

Use `PRECEDES` to indicate that the trigger being created must fire before the specified triggers. You can specify `PRECEDES` only for a reverse crossedition trigger.

The specified triggers must exist, and they must have been successfully compiled. They need not be enabled.

If you are creating a noncrossedition trigger, then the specified triggers must be all of the following:

- Noncrossedition triggers
- Defined on the same table as the trigger being created
- Visible in the same edition as the trigger being created

If you are creating a crossedition trigger, then the specified triggers must be all of the following:

- Crossedition triggers
- Defined on the same table or editioning view as the trigger being created, unless you specify `FOLLOWS` or `PRECEDES`.

If you specify `FOLLOWS`, then the specified triggers must be forward crossedition triggers, and if you specify `PRECEDES`, then the specified triggers must be reverse crossedition triggers. However, the specified triggers need not be on the same table or editioning view as the trigger being created.

- Visible in the same edition as the trigger being created

In the following definitions, A, B, C, and D are either noncrossedition triggers or forward crossedition triggers:

- If B specifies A in its `FOLLOWS` clause, then B **directly follows** A.
- If C directly follows B, and B directly follows A, then C **indirectly follows** A.
- If D directly follows C, and C indirectly follows A, then D indirectly follows A.
- If B directly or indirectly follows A, then B **explicitly follows** A (that is, the firing order of B and A is explicitly specified by one or more `FOLLOWS` clauses).

In the following definitions, A, B, C, and D are reverse crossedition triggers:

- If A specifies B in its `PRECEDES` clause, then A **directly precedes** B.
- If A directly precedes B, and B directly precedes C, then A **indirectly precedes** C.
- If A directly precedes B, and B indirectly precedes D, then A indirectly precedes D.
- If A directly or indirectly precedes B, then A **explicitly precedes** B (that is, the firing order of A and B is explicitly specified by one or more `PRECEDES` clauses).

Belongs to *compound_dml_trigger*.

compound_trigger_block

If the trigger is created on a nonconditioning view, then *compound_trigger_block* must have only the `INSTEAD OF EACH ROW` section.

If the trigger is created on a table or editioning view, then timing point sections can be in any order, but no section can be repeated. The *compound_trigger_block* cannot have an `INSTEAD OF EACH ROW` section.



See Also:

["Compound DML Trigger Structure"](#)

Restriction on *compound_trigger_block*

The *declare_section* of *compound_trigger_block* cannot include `PRAGMA AUTONOMOUS_TRANSACTION`.



See Also:

["Compound DML Trigger Restrictions"](#)

timing_point

BEFORE STATEMENT

Specifies the `BEFORE STATEMENT` section of a *compound_dml_trigger* on a table or editioning view. This section causes the database to fire the trigger before running the triggering event.

Restriction on BEFORE STATEMENT

This section cannot specify `:NEW` or `:OLD`.

BEFORE EACH ROW

Specifies the `BEFORE EACH ROW` section of a *compound_dml_trigger* on a table or editioning view. This section causes the database to fire the trigger before running the triggering event. The trigger fires before each affected row is changed.

This section can read and write the `:OLD` and `:NEW` fields.

AFTER STATEMENT

Specifies the `AFTER STATEMENT` section of *compound_dml_trigger* on a table or editioning view. This section causes the database to fire the trigger after running the triggering event.

Restriction on AFTER STATEMENT

This section cannot specify `:NEW` or `:OLD`.

AFTER EACH ROW

Specifies the `AFTER EACH ROW` section of a *compound_dml_trigger* on a table or editioning view. This section causes the database to fire the trigger after running the triggering event. The trigger fires after each affected row is changed.

This section can read but not write the `:OLD` and `:NEW` fields.

INSTEAD OF EACH ROW

Specifies the `INSTEAD OF EACH ROW` section (the only timing point section) of a *compound_dml_trigger* on a noneditioning view. The database runs *tps_body* instead of running the triggering DML statement. For more information, see "[INSTEAD OF DML Triggers](#)".

Restriction on INSTEAD OF EACH ROW

- This section can appear only in a *compound_dml_trigger* on a noneditioning view.
- This section can read but not write the `:OLD` and `:NEW` values.

tps_body

The PL/SQL block or `CALL` subprogram that the database runs to fire the trigger. A `CALL` subprogram is either a PL/SQL subprogram or a Java subprogram in a PL/SQL wrapper.

If *tps_body* is a PL/SQL block and it contains errors, then the `CREATE [OR REPLACE]` statement fails.

Restriction on *tps_body*

The *declare_section* cannot declare variables of the data type `LONG` or `LONG RAW`.

Examples

DML Triggers

- [Example 9-1](#), "Trigger Uses Conditional Predicates to Detect Triggering Statement"
- [Example 9-2](#), "INSTEAD OF Trigger"
- [Example 9-3](#), "INSTEAD OF Trigger on Nested Table Column of View"
- [Example 9-4](#), "Compound Trigger Logs Changes to One Table in Another Table"
- [Example 9-5](#), "Compound Trigger Avoids Mutating-Table Error"

Triggers for Ensuring Referential Integrity

- [Example 9-6](#), "Foreign Key Trigger for Child Table"
- [Example 9-7](#), "UPDATE and DELETE RESTRICT Trigger for Parent Table"
- [Example 9-8](#), "UPDATE and DELETE SET NULL Trigger for Parent Table"
- [Example 9-9](#), "DELETE CASCADE Trigger for Parent Table"
- [Example 9-10](#), "UPDATE CASCADE Trigger for Parent Table"
- [Example 9-11](#), "Trigger Checks Complex Constraints"
- [Example 9-12](#), "Trigger Enforces Security Authorizations"
- [Example 9-13](#), "Trigger Derives New Column Values"

Triggers That Use Correlation Names and Pseudorecords

- [Example 9-14](#), "Trigger Logs Changes to EMPLOYEES.SALARY"
- [Example 9-15](#), "Conditional Trigger Prints Salary Change Information"
- [Example 9-16](#), "Trigger Modifies CLOB Columns"
- [Example 9-17](#), "Trigger with REFERENCING Clause"
- [Example 9-18](#), "Trigger References OBJECT_VALUE Pseudocolumn"

System Triggers

- [Example 9-19](#), "BEFORE Statement Trigger on Sample Schema HR"
- [Example 9-20](#), "AFTER Statement Trigger on Database"
- [Example 9-21](#), "Trigger Monitors Logons"
- [Example 9-22](#), "INSTEAD OF CREATE Trigger on Schema"

Miscellaneous Trigger Examples

- [Example 9-23](#), "Trigger Invokes Java Subprogram"
- [Example 9-24](#), "Trigger Cannot Handle Exception if Remote Database is Unavailable"
- [Example 9-25](#), "Workaround for Trigger Cannot Handle Exception if Remote Database is Unavailable"
- [Example 9-26](#), "Trigger Causes Mutating-Table Error"
- [Example 9-27](#), "Update Cascade"
- [Example 9-28](#), "Viewing Information About Triggers"

Related Topics

In this chapter:

- ["ALTER TRIGGER Statement"](#)
- ["DROP TRIGGER Statement"](#)

In other chapters:

- [PL/SQL Triggers](#)



See Also:

Oracle Database Development Guide for more information about crossedition triggers

14.13 CREATE TYPE Statement

The `CREATE TYPE` statement specifies the name of the type and its attributes, methods, and other properties.

The `CREATE TYPE` statement creates or replaces the specification of one of these:

- Abstract Data Type (ADT)

- Standalone varying array (varray) type
- Standalone nested table type
- Incomplete object type

An **incomplete type** is a type created by a forward type definition. It is called incomplete because it has a name but no attributes or methods. It can be referenced by other types, allowing you to define types that refer to each other. However, you must fully specify the type before you can use it to create a table or an object column or a column of a nested table type.

The `CREATE TYPE BODY` statement contains the code for the methods that implement the type.

 **Note:**

- If you create a type whose specification declares only attributes but no methods, then you need not specify a type body.
- A standalone collection type that you create with the `CREATE TYPE` statement differs from a collection type that you define with the keyword `TYPE` in a PL/SQL block or package. For information about the latter, see "[Collection Variable Declaration](#)".
- With the `CREATE TYPE` statement, you can create nested table and `VARRAY` types, but not associative arrays. In a PL/SQL block or package, you can define all three collection types.

Topics

- [Prerequisites](#)
- [Syntax](#)
- [Semantics](#)
- [Examples](#)
- [Related Topics](#)

Prerequisites

To create a type in your schema, you must have the `CREATE TYPE` system privilege. To create a type in another user's schema, you must have the `CREATE ANY TYPE` system privilege. You can acquire these privileges explicitly or be granted them through a role.

To create a subtype, you must have the `UNDER ANY TYPE` system privilege or the `UNDER` object privilege on the supertype.

The owner of the type must be explicitly granted the `EXECUTE` object privilege to access all other types referenced in the definition of the type, or the type owner must be granted the `EXECUTE ANY TYPE` system privilege. The owner cannot obtain these privileges through roles.

If the type owner intends to grant other users access to the type, then the owner must be granted the `EXECUTE` object privilege on the referenced types with the `GRANT OPTION`

or the EXECUTE ANY TYPE system privilege with the ADMIN OPTION. Otherwise, the type owner has insufficient privileges to grant access on the type to other users.

Syntax

create_type ::=

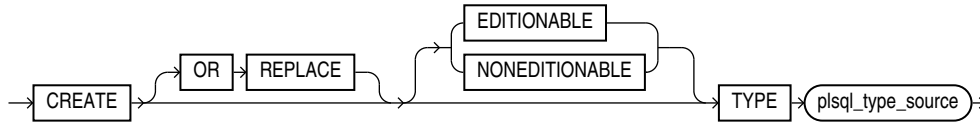

plsql_type_source ::=

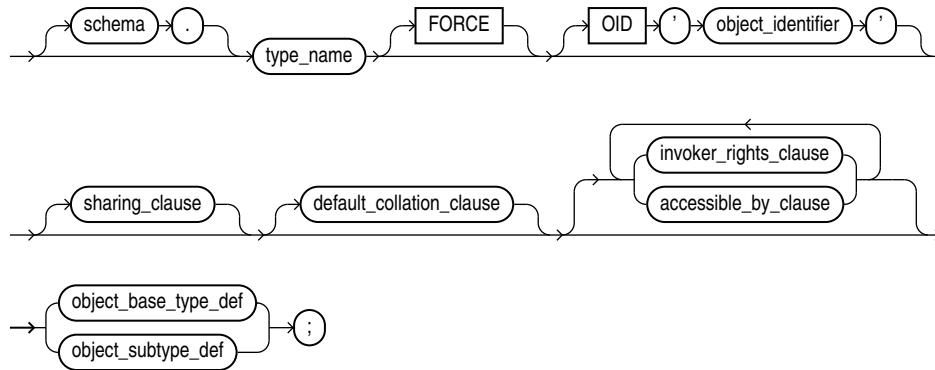

(*sharing_clause ::=*, *default_collation_clause ::=*, *accessible_by_clause ::=*, *invoker_rights_clause ::=*, *object_base_type_def ::=*, *object_subtype_def ::=*)

object_base_type_def ::=

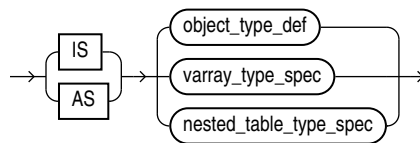

(*object_type_def ::=*, *nested_table_type_spec ::=*, *varray_type_spec ::=*)

object_subtype_def ::=

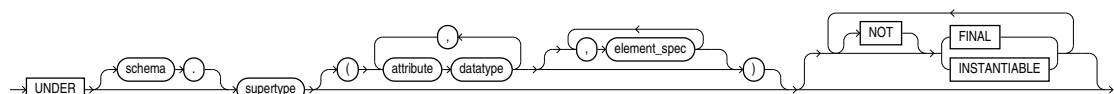

(*datatype ::=*, *element_spec ::=*)

object_type_def ::=

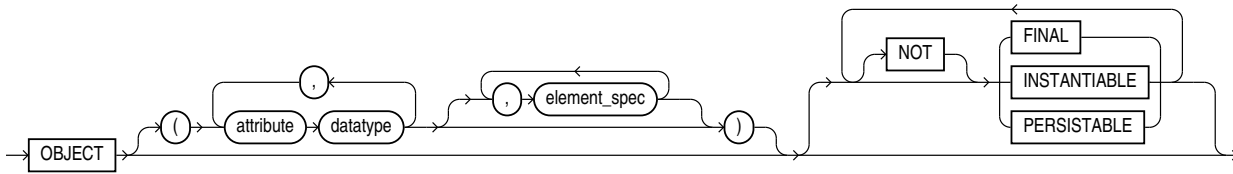

(*datatype* ::=, *element_spec* ::=)

varray_type_spec ::=

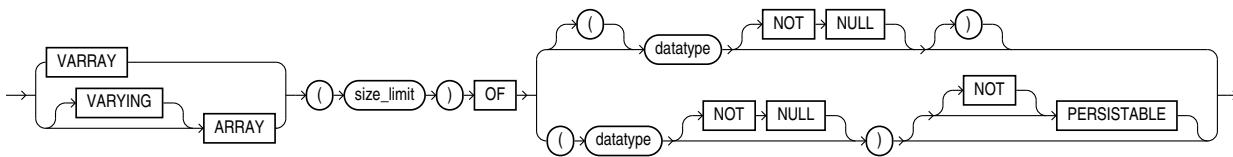

(*datatype* ::=)

nested_table_type_spec ::=

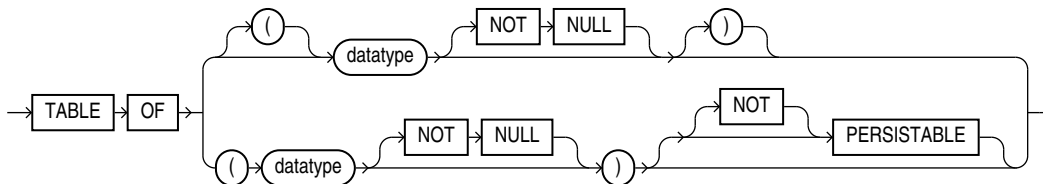

(*datatype* ::=)

Semantics

create_type

OR REPLACE

Re-creates the type if it exists, and recompiles it.

Users who were granted privileges on the type before it was redefined can still access the type without being regranted the privileges.

If any function-based indexes depend on the type, then the database marks the indexes **DISABLED**.

[EDITIONABLE | NONEDITIONABLE]

Specifies whether the type is an editioned or noneditioned object if editioning is enabled for the schema object type **TYPE** in *schema*. **Default:** **EDITIONABLE**. For

information about editioned and noneditioned objects, see *Oracle Database Development Guide*.

plsql_type_source

schema

Name of the schema containing the type. **Default:** your schema.

type_name

Name of an ADT, a nested table type, or a `VARRAY` type.

If creating the type results in compilation errors, then the database returns an error. You can see the associated compiler error messages with the SQL*Plus command `SHOW ERRORS`.

The database implicitly defines a constructor method for each user-defined type that you create. A **constructor** is a system-supplied procedure that is used in SQL statements or in PL/SQL code to construct an instance of the type value. The name of the constructor method is the name of the user-defined type. You can also create a user-defined constructor using the *constructor_spec* syntax.

The parameters of the ADT constructor method are the data attributes of the ADT. They occur in the same order as the attribute definition order for the ADT. The parameters of a nested table or varray constructor are the elements of the nested table or the varray.

FORCE

If *type_name* exists and has type dependents, but not table dependents, `FORCE` forces the statement to replace the type. (If *type_name* has table dependents, the statement fails with or without `FORCE`.)

Note:

If type `t1` has type dependent `t2`, and type `t2` has table dependents, then type `t1` also has table dependents.

See Also:

Oracle Database Object-Relational Developer's Guide

OID 'object_identifier'

Establishes type equivalence of identical objects in multiple databases. See *Oracle Database Object-Relational Developer's Guide* for information about this clause.

object_base_type_def

Creates a schema-level ADT. Such ADTs are sometimes called **root** ADTs.

IS | AS

The keyword `IS` or `AS` is required when creating an ADT.

 **See Also:**

["Example 14-23"](#)

object_subtype_def

Creates a subtype of an existing type.

UNDER *supertype*

The existing supertype must be an ADT. The subtype you create in this statement inherits the properties of its supertype. It must either override some of those properties or add properties to distinguish it from the supertype.

 **See Also:**

["Example 14-24"](#) and ["Example 14-25"](#)

attribute

Name of an ADT attribute. An ADT attribute is a data item with a name and a type specifier that forms the structure of the ADT. You must specify at least one attribute for each ADT. The name must be unique in the ADT, but can be used in other ADTs.

If you are creating a subtype, then the attribute name cannot be the same as any attribute or method name declared in the supertype chain.

datatype

The data type of an ADT attribute. This data type must be stored in the database; that is, either a predefined data type or a user-defined standalone collection type.

Restrictions on *datatype*

- You cannot impose the `NOT NULL` constraint on an attribute.
- You cannot specify attributes of type `ROWID`, `LONG`, or `LONG RAW`.
- You cannot specify a data type of `UROWID` for an ADT.
- If you specify an object of type `REF`, then the target object must have an object identifier.
- If you are creating a collection type for use as a nested table or varray column of a table, then you cannot specify attributes of type `ANYTYPE`, `ANYDATA`, or `ANYDATASET`.

object_type_def

Creates an ADT. The variables that form the data structure are called **attributes**. The member subprograms that define the behavior of the ADT are called **methods**.

OBJECT

The keyword `OBJECT` is required.

[NOT] FINAL, [NOT] INSTANTIABLE , [NOT] PERSISTABLE

At the schema level of the syntax, these clauses specify the inheritance attributes of the type.

[NOT] FINAL

Use the `[NOT] FINAL` clause to indicate whether any further subtypes can be created for this type:

- **(Default)** Specify `FINAL` if no further subtypes can be created for this type.
- Specify `NOT FINAL` if further subtypes can be created under this type.

[NOT] INSTANTIABLE

Use the `[NOT] INSTANTIABLE` clause to indicate whether any object instances of this type can be constructed:

- **(Default)** Specify `INSTANTIABLE` if object instances of this type can be constructed.
- Specify `NOT INSTANTIABLE` if no default or user-defined constructor exists for this ADT. You must specify these keywords for any type with noninstantiable methods and for any type that has no attributes, either inherited or specified in this statement.

[NOT] PERSISTABLE

Use `[NOT] PERSISTABLE` clause to indicate whether or not instances of the object type are persistable.

Only `PERSISTABLE` types can be stored in a table.

- **(Default)** You can specify `PERSISTABLE` if all the object type attributes are persistable. Creating a persistable object type with non-persistable attributes is not allowed.
- You can specify `NOT PERSISTABLE` if the object type attributes are persistable or non-persistable.

Restrictions on [NOT] PERSISTABLE

You cannot specify the `[NOT] PERSISTABLE` clause in a subtype definition. The persistence property of a subtype is inherited from its supertype.

varray_type_spec

Creates the type as an ordered set of elements, each of which has the same data type.

Restrictions on *varray_type_spec*

You can create a `VARRAY` type of `XMLType` or of a LOB type for procedural purposes, for example, in PL/SQL or in view queries. However, database storage of such a `varray` is not supported, so you cannot create an object table or a column of such a `VARRAY` type.

**See Also:**

["Example 14-26"](#)

[NOT] PERSISTABLE**(datatype [NOT NULL])**

The parentheses before and after the `datatype [NOT NULL]` clause are required when `PERSISTABLE` is specified. The parentheses are optional if `PERSISTABLE` is not specified.

Use `[NOT] PERSISTABLE` clause to indicate whether or not instances of the collection type (`VARRAY` or nested table) are persistable.

- **(Default)** A collection can be `PERSISTABLE` only if the collection element type is persistable. Creating a persistable collection type with non-persistable element type is not allowed.
- Specify `NOT PERSISTABLE` if any element type of the collection is not persistable. You can specify `NOT PERSISTABLE` for any collection, whether the element type is persistable or not.

nested_table_type_spec

Creates a named nested table of type `datatype`.

[NOT] PERSISTABLE

Same as for `VARRAY`, see "[\[NOT\] PERSISTABLE](#)"

 **See Also:**

- "[Example 14-27](#)"
- "[Example 14-28](#)"

Examples**Example 14-23 ADT Examples**

This example shows how the sample type `customer_typ` was created for the sample Order Entry (oe) schema. A hypothetical name is given to the table so that you can duplicate this example in your test database:

```
CREATE TYPE customer_typ_demo AS OBJECT
  ( customer_id      NUMBER(6)
    , cust_first_name  VARCHAR2(20)
    , cust_last_name   VARCHAR2(20)
    , cust_address     CUST_ADDRESS_TYP
    , phone_numbers    PHONE_LIST_TYP
    , nls_language     VARCHAR2(3)
    , nls_territory    VARCHAR2(30)
    , credit_limit     NUMBER(9,2)
    , cust_email       VARCHAR2(30)
    , cust_orders      ORDER_LIST_TYP
  ) ;
```

In this example, the `data_typ1` ADT is created with one member function `prod`, which is implemented in the `CREATE TYPE BODY` statement:

```

CREATE TYPE data_typ1 AS OBJECT
  ( year NUMBER,
    MEMBER FUNCTION prod(invent NUMBER) RETURN NUMBER
  );
/

CREATE TYPE BODY data_typ1 IS
  MEMBER FUNCTION prod (invent NUMBER) RETURN NUMBER IS
  BEGIN
    RETURN (year + invent);
  END;
END;

```

Example 14-24 Creating a Subtype

This statement shows how the subtype `corporate_customer_typ` in the sample oe schema was created.

It is based on the `customer_typ` supertype created in the preceding example and adds the `account_mgr_id` attribute. A hypothetical name is given to the table so that you can duplicate this example in your test database:

```

CREATE TYPE corporate_customer_typ_demo UNDER customer_typ
  ( account_mgr_id NUMBER(6)
  );

```

Example 14-25 Creating a Type Hierarchy

These statements create a type hierarchy.

Type `employee_t` inherits the `name` and `ssn` attributes from type `person_t` and in addition has `department_id` and `salary` attributes. Type `part_time_emp_t` inherits all of the attributes from `employee_t` and, through `employee_t`, those of `person_t` and in addition has a `num_hrs` attribute. Type `part_time_emp_t` is final by default, so no further subtypes can be created under it.

```

CREATE TYPE person_t AS OBJECT (name VARCHAR2(100), ssn NUMBER)
  NOT FINAL;

CREATE TYPE employee_t UNDER person_t
  (department_id NUMBER, salary NUMBER) NOT FINAL;

CREATE TYPE part_time_emp_t UNDER employee_t (num_hrs NUMBER);

```

You can use type hierarchies to create substitutable tables and tables with substitutable columns.

Example 14-26 Creating a Varray Type

This statement shows how the `phone_list_typ` VARRAY type with five elements in the sample oe schema was created.

A hypothetical name is given to the table so that you can duplicate this example in your test database:

```

CREATE TYPE phone_list_typ_demo AS VARRAY(5) OF VARCHAR2(25);

```

Example 14-27 Creating a Nested Table Type

This example from the sample schema `pm` creates the table type `textdoc_tab` of type `textdoc_typ`:

```
CREATE TYPE textdoc_typ AS OBJECT
  ( document_typ    VARCHAR2(32)
    , formatted_doc  BLOB
  ) ;

CREATE TYPE textdoc_tab AS TABLE OF textdoc_typ;
```

Example 14-28 Creating a Nested Table Type Containing a Varray

This example of multilevel collections is a variation of the sample table `oe.customers`.

In this example, the `cust_address` object column becomes a nested table column with the `phone_list_typ` varray column embedded in it. The `phone_list_typ_demo` type was created in "Example 14-26".

```
CREATE TYPE cust_address_typ2 AS OBJECT
  ( street_address  VARCHAR2(40)
    , postal_code    VARCHAR2(10)
    , city           VARCHAR2(30)
    , state_province VARCHAR2(10)
    , country_id     CHAR(2)
    , phone          phone_list_typ_demo
  );

CREATE TYPE cust_nt_address_typ
  AS TABLE OF cust_address_typ2;
```

Example 14-29 Constructor Example

This example invokes the system-defined constructor to construct the `demo_typ` object and insert it into the `demo_tab` table.

```
CREATE TYPE demo_typ1 AS OBJECT (a1 NUMBER, a2 NUMBER);

CREATE TABLE demo_tab1 (b1 NUMBER, b2 demo_typ1);

INSERT INTO demo_tab1 VALUES (1, demo_typ1(2,3));
```

Example 14-30 Creating a Member Method

This example invokes method constructor `col.get_square`.

First the type is created:

```
CREATE TYPE demo_typ2 AS OBJECT (a1 NUMBER,
  MEMBER FUNCTION get_square RETURN NUMBER);
```

Next a table is created with an ADT column and some data is inserted into the table:

```
CREATE TABLE demo_tab2(col demo_typ2);

INSERT INTO demo_tab2 VALUES (demo_typ2(2));
```

The type body is created to define the member function, and the member method is invoked:

```
CREATE TYPE BODY demo_typ2 IS
  MEMBER FUNCTION get_square
  RETURN NUMBER
  IS x NUMBER;
  BEGIN
    SELECT c.col.a1*c.col.a1 INTO x
```

```

        FROM demo_tab2 c;
        RETURN (x);
    END;
END;

SELECT t.col.get_square() FROM demo_tab2 t;

T.COL.GET_SQUARE()
-----
                4

```

Unlike function invocations, method invocations require parentheses, even when the methods do not have additional arguments.

Example 14-31 Creating a Static Method

This example changes the definition of the `employee_t` type to associate it with the `construct_emp` function.

The example first creates an ADT `department_t` and then an ADT `employee_t` containing an attribute of type `department_t`:

```

CREATE OR REPLACE TYPE department_t AS OBJECT (
    deptno number(10),
    dname CHAR(30));

CREATE OR REPLACE TYPE employee_t AS OBJECT(
    empid RAW(16),
    ename CHAR(31),
    dept REF department_t,
    STATIC function construct_emp
        (name VARCHAR2, dept REF department_t)
        RETURN employee_t
);

```

This statement requires this type body statement.

```

CREATE OR REPLACE TYPE BODY employee_t IS
    STATIC FUNCTION construct_emp
        (name varchar2, dept REF department_t)
        RETURN employee_t IS
    BEGIN
        return employee_t(SYS_GUID(),name,dept);
    END;
END;

```

Next create an object table and insert into the table:

```

CREATE TABLE emptab OF employee_t;
INSERT INTO emptab
    VALUES (employee_t.construct_emp('John Smith', NULL));

```

Related Topics

In this chapter:

- [ALTER TYPE Statement](#)
- [CREATE TYPE BODY Statement](#)
- [DROP TYPE Statement](#)

In other chapters:

- [Abstract Data Types](#)
- [Conditional Compilation Directive Restrictions](#)
- [Collection Variable Declaration](#)
- [Collection Types](#) for information about user-defined standalone collection types
- [PL/SQL Data Types](#)

In other books:

- *Oracle Database Object-Relational Developer's Guide* for more information about objects, incomplete types, varrays, and nested tables
- *Oracle Database Object-Relational Developer's Guide* for more information about constructors

14.14 CREATE TYPE BODY Statement

The `CREATE TYPE BODY` defines or implements the member methods defined in the type specification that was created with the `CREATE TYPE` statement.

For each method specified in a type specification for which you did not specify the `call_spec`, you must specify a corresponding method body in the type body.

Topics

- [Prerequisites](#)
- [Syntax](#)
- [Semantics](#)
- [Examples](#)
- [Related Topics](#)

Prerequisites

Every member declaration in the `CREATE TYPE` specification for an ADT must have a corresponding construct in the `CREATE TYPE` or `CREATE TYPE BODY` statement.

To create or replace a type body in your schema, you must have the `CREATE TYPE` or the `CREATE ANY TYPE` system privilege. To create a type in another user's schema, you must have the `CREATE ANY TYPE` system privilege. To replace a type in another user's schema, you must have the `DROP ANY TYPE` system privilege.

Syntax

`create_type_body ::=`

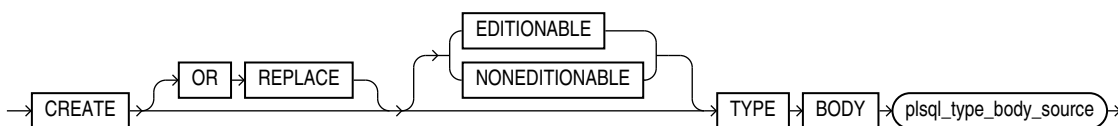

plsql_type_body_source ::=

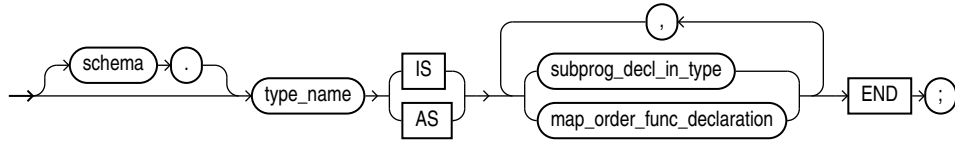

(map_order_func_declaration ::=, subprog_decl_in_type ::=)

subprog_decl_in_type ::=

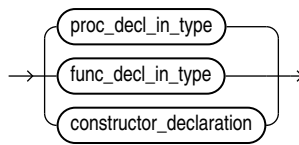

proc_decl_in_type ::=

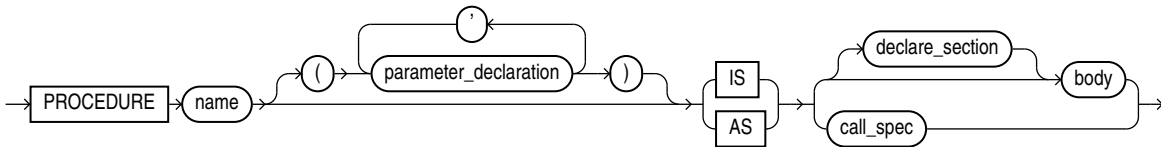

(body ::=, call_spec ::=, declare_section ::=, parameter_declaration ::=)

func_decl_in_type ::=

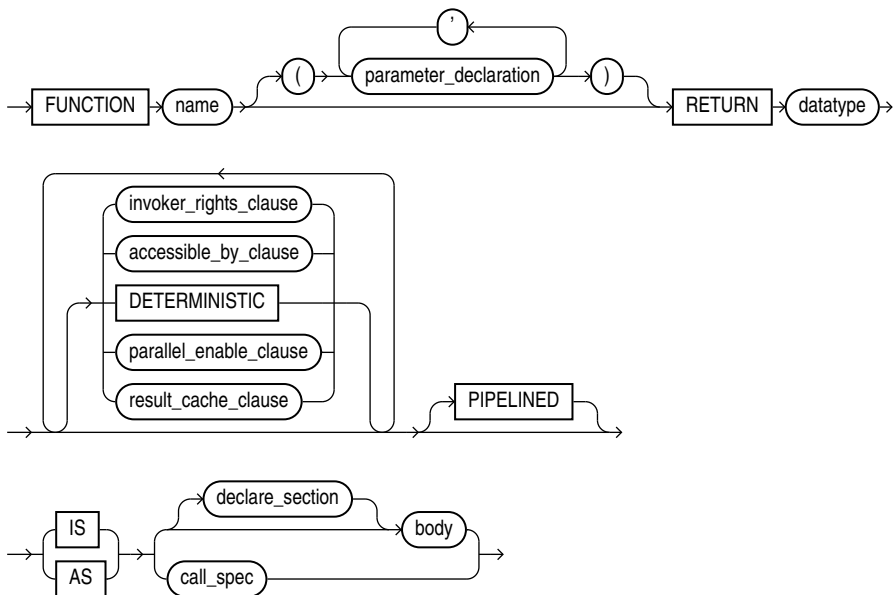

(*body ::=, invoker_rights_clause ::=, accessible_by_clause ::=, deterministic_clause ::=, call_spec ::=, declare_section ::=, parameter_declaration ::=, parallel_enable_clause ::=, result_cache_clause ::=, pipelined_clause ::=*)

constructor_declaration ::=

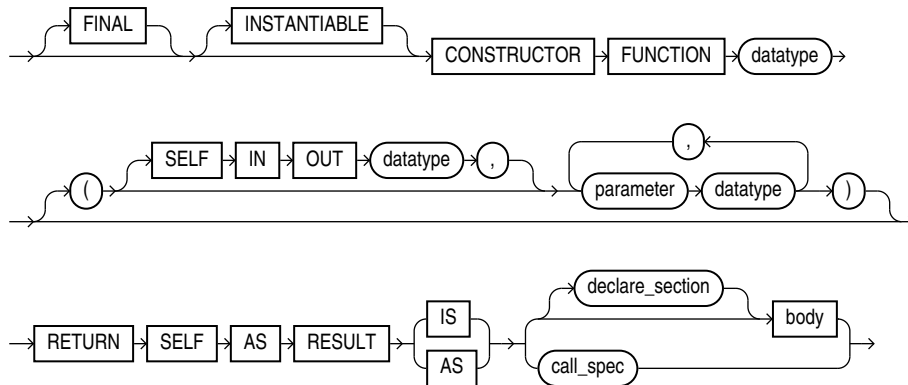

(*call_spec ::=*)

map_order_func_declaration ::=



Semantics

create_type_body

OR REPLACE

Re-creates the type body if it exists, and recompiles it.

Users who were granted privileges on the type body before it was redefined can still access the type body without being regranted the privileges.

You can use this clause to add member subprogram definitions to specifications added with the ALTER TYPE ... REPLACE statement.

[EDITIONABLE | NONEDITIONABLE]

If you do not specify this property, then the type body inherits EDITIONABLE or NONEDITIONABLE from the type specification. If you do specify this property, then it must match that of the type specification.

plsql_type_body_source

schema

Name of the schema containing the type body. **Default:** your schema.

type_name

Name of an ADT.

subprog_decl_in_type

The type of function or procedure subprogram associated with the type specification.

You must define a corresponding method name and optional parameter list in the type specification for each procedure or function declaration. For functions, you also must specify a return type.

map_order_func_declaration

You can declare either one `MAP` method or one `ORDER` method, regardless of how many `MEMBER` or `STATIC` methods you declare. If you declare either a `MAP` or `ORDER` method, then you can compare object instances in SQL.

If you do not declare either method, then you can compare object instances only for equality or inequality. Instances of the same type definition are equal only if each pair of their corresponding attributes is equal.

MAP MEMBER

Declares or implements a `MAP` member function that returns the relative position of a given instance in the ordering of all instances of the object. A `MAP` method is called implicitly and specifies an ordering of object instances by mapping them to values of a predefined scalar type. PL/SQL uses the ordering to evaluate Boolean expressions and to perform comparisons.

If the argument to the `MAP` method is null, then the `MAP` method returns null and the method is not invoked.

An type body can contain only one `MAP` method, which must be a function. The `MAP` function can have no arguments other than the implicit `SELF` argument.

ORDER MEMBER

Specifies an `ORDER` member function that takes an instance of an object as an explicit argument and the implicit `SELF` argument and returns either a negative integer, zero, or a positive integer, indicating that the implicit `SELF` argument is less than, equal to, or greater than the explicit argument, respectively.

If either argument to the `ORDER` method is null, then the `ORDER` method returns null and the method is not invoked.

When instances of the same ADT definition are compared in an `ORDER BY` clause, the database invokes the `ORDER MEMBER func_decl_in_type`.

An object specification can contain only one `ORDER` method, which must be a function having the return type `NUMBER`.

proc_decl_in_type

A procedure subprogram declaration.

constructor_declaration

A user-defined constructor subprogram declaration. The `RETURN` clause of a constructor function must be `RETURN SELF AS RESULT`. This setting indicates that the most specific type of

the value returned by the constructor function is the most specific type of the `SELF` argument that was passed in to the constructor function.

 **See Also:**

- "[CREATE TYPE Statement](#)" for a list of restrictions on user-defined functions
- "[Overloaded Subprograms](#)" for information about overloading subprogram names
- *Oracle Database Object-Relational Developer's Guide* for information about and examples of user-defined constructors

declare_section

Declares items that are local to the procedure or function.

body

Procedure or function statements.

func_decl_in_type

A function subprogram declaration.

Examples

Several examples of creating type bodies appear in the [Examples](#) section of "[CREATE TYPE Statement](#)". For an example of re-creating a type body, see "[Example 14-7](#)".

Related Topics

- "[CREATE TYPE Statement](#)"
- "[DROP TYPE BODY Statement](#)"
- "[CREATE FUNCTION Statement](#)"
- "[CREATE PROCEDURE Statement](#)"

14.15 DROP FUNCTION Statement

The `DROP FUNCTION` statement drops a standalone function from the database.

 **Note:**

Do not use this statement to drop a function that is part of a package. Instead, either drop the entire package using the "[DROP PACKAGE Statement](#)" or redefine the package without the function using the "[CREATE PACKAGE Statement](#)" with the `OR REPLACE` clause.

Topics

- [Prerequisites](#)
- [Syntax](#)
- [Semantics](#)
- [Example](#)
- [Related Topics](#)

Prerequisites

The function must be in your schema or you must have the `DROP ANY PROCEDURE` system privilege.

Syntax

drop_function ::=

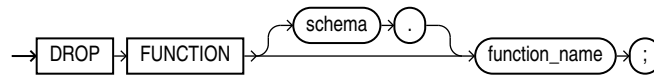

Semantics

drop_function

schema

Name of the schema containing the function. **Default:** your schema.

function_name

Name of the function to be dropped.

The database invalidates any local objects that depend on, or invoke, the dropped function. If you subsequently reference one of these objects, then the database tries to recompile the object and returns an error if you have not re-created the dropped function.

If any statistics types are associated with the function, then the database disassociates the statistics types with the `FORCE` option and drops any user-defined statistics collected with the statistics type.

See Also:

- *Oracle Database SQL Language Reference* for information about the `ASSOCIATE STATISTICS` statement
- *Oracle Database SQL Language Reference* for information about the `DISASSOCIATE STATISTICS` statement

Example

Example 14-32 Dropping a Function

This statement drops the function `SecondMax` in the sample schema `oe` and invalidates all objects that depend upon `SecondMax`:

```
DROP FUNCTION oe.SecondMax;
```



See Also:

"[Example 14-15](#)" for information about creating the `SecondMax` function

Related Topics

- "[ALTER FUNCTION Statement](#)"
- "[CREATE FUNCTION Statement](#)"

14.16 DROP LIBRARY Statement

The `DROP LIBRARY` statement drops an external procedure library from the database.

Topics

- [Prerequisites](#)
- [Syntax](#)
- [Semantics](#)
- [Example](#)
- [Related Topics](#)

Prerequisites

You must have the `DROP ANY LIBRARY` system privilege.

Syntax

drop_library ::=

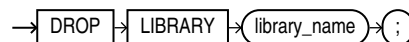

Semantics

library_name

Name of the external procedure library being dropped.

Example

Example 14-33 Dropping a Library

The following statement drops the `ext_lib` library, which was created in "CREATE LIBRARY Statement":

```
DROP LIBRARY ext_lib;
```

Related Topics

- "ALTER LIBRARY Statement"
- "CREATE LIBRARY Statement"

14.17 DROP PACKAGE Statement

The `DROP PACKAGE` statement drops a stored package from the database.

This statement drops the body and specification of a package.



Note:

Do not use this statement to drop a single object from a package. Instead, re-create the package without the object using the "CREATE PACKAGE Statement" and "CREATE PACKAGE BODY Statement" with the `OR REPLACE` clause.

Topics

- Prerequisites
- Syntax
- Semantics
- Example
- Related Topics

Prerequisites

The package must be in your schema or you must have the `DROP ANY PROCEDURE` system privilege.

Syntax

drop_package ::=

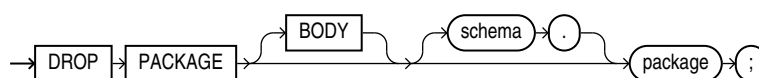

Semantics

drop_package

BODY

Drops only the body of the package. If you omit this clause, then the database drops both the body and specification of the package.

When you drop only the body of a package but not its specification, the database does not invalidate dependent objects. However, you cannot invoke a procedure or stored function declared in the package specification until you re-create the package body.

schema

Name of the schema containing the package. **Default:** your schema.

package

Name of the package to be dropped.

The database invalidates any local objects that depend on the package specification. If you subsequently reference one of these objects, then the database tries to recompile the object and returns an error if you have not re-created the dropped package.

If any statistics types are associated with the package, then the database disassociates the statistics types with the `FORCE` clause and drops any user-defined statistics collected with the statistics types.



See Also:

- *Oracle Database SQL Language Reference* for information about the `ASSOCIATE STATISTICS` statement
- *Oracle Database SQL Language Reference* for information about the `DISASSOCIATE STATISTICS` statement

Example

Example 14-34 Dropping a Package

This statement drops the specification and body of the `emp_mgmt` package, which was created in "[CREATE PACKAGE BODY Statement](#)", invalidating all objects that depend on the specification:

```
DROP PACKAGE emp_mgmt;
```

Related Topics

- "[ALTER PACKAGE Statement](#)"
- "[CREATE PACKAGE Statement](#)"
- "[CREATE PACKAGE BODY Statement](#)"

14.18 DROP PROCEDURE Statement

The `DROP PROCEDURE` statement drops a standalone procedure from the database.

Note:

Do not use this statement to remove a procedure that is part of a package. Instead, either drop the entire package using the "[DROP PACKAGE Statement](#)", or redefine the package without the procedure using the "[CREATE PACKAGE Statement](#)" with the `OR REPLACE` clause.

Topics

- [Prerequisites](#)
- [Syntax](#)
- [Semantics](#)
- [Example](#)
- [Related Topics](#)

Prerequisites

The procedure must be in your schema or you must have the `DROP ANY PROCEDURE` system privilege.

Syntax

drop_procedure ::=

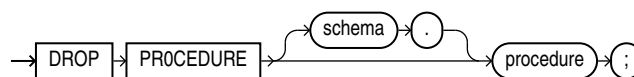

Semantics

schema

Name of the schema containing the procedure. **Default:** your schema.

procedure

Name of the procedure to be dropped.

When you drop a procedure, the database invalidates any local objects that depend upon the dropped procedure. If you subsequently reference one of these objects, then the database tries to recompile the object and returns an error message if you have not re-created the dropped procedure.

Example

Example 14-35 Dropping a Procedure

This statement drops the procedure `remove_emp` owned by the user `hr` and invalidates all objects that depend upon `remove_emp`:

```
DROP PROCEDURE hr.remove_emp;
```

Related Topics

- ["ALTER PROCEDURE Statement"](#)
- ["CREATE PROCEDURE Statement"](#)

14.19 DROP TRIGGER Statement

The `DROP TRIGGER` statement drops a database trigger from the database.

Topics

- [Prerequisites](#)
- [Syntax](#)
- [Semantics](#)
- [Example](#)
- [Related Topics](#)

Prerequisites

The trigger must be in your schema or you must have the `DROP ANY TRIGGER` system privilege. To drop a trigger on `DATABASE` in another user's schema, you must also have the `ADMINISTER DATABASE TRIGGER` system privilege.

Syntax

drop_trigger ::=

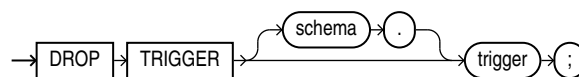

Semantics

schema

Name of the schema containing the trigger. **Default:** your schema.

trigger

Name of the trigger to be dropped.

Example**Example 14-36 Dropping a Trigger**

This statement drops the `salary_check` trigger in the schema `hr`:

```
DROP TRIGGER hr.salary_check;
```

Related Topics

- ["ALTER TRIGGER Statement"](#)
- ["CREATE TRIGGER Statement"](#)

14.20 DROP TYPE Statement

The `DROP TYPE` statement drops the specification and body of an ADT, `VARRAY` type, or nested table type.

Topics

- [Prerequisites](#)
- [Syntax](#)
- [Semantics](#)
- [Example](#)
- [Related Topics](#)

Prerequisites

The ADT, `VARRAY` type, or nested table type must be in your schema or you must have the `DROP ANY TYPE` system privilege.

Syntax

drop_type ::=

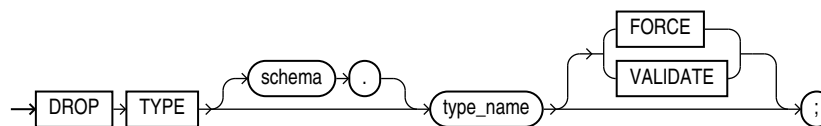
**Semantics*****schema***

Name of the schema containing the type. **Default:** your schema.

type_name

Name of the object, `varray`, or nested table type to be dropped. You can drop only types with no type or table dependencies.

If *type_name* is a supertype, then this statement fails unless you also specify `FORCE`. If you specify `FORCE`, then the database invalidates all subtypes depending on this supertype.

If *type_name* is a statistics type, then this statement fails unless you also specify `FORCE`. If you specify `FORCE`, then the database first disassociates all objects that are associated with *type_name* and then drops *type_name*.

 **See Also:**

- *Oracle Database SQL Language Reference* for information about the `ASSOCIATE STATISTICS` statement
- *Oracle Database SQL Language Reference* for information about the `DISASSOCIATE STATISTICS` statement

If *type_name* is an ADT that is associated with a statistics type, then the database first tries to disassociate *type_name* from the statistics type and then drops *type_name*. However, if statistics have been collected using the statistics type, then the database cannot disassociate *type_name* from the statistics type, and this statement fails.

If *type_name* is an implementation type for an index type, then the index type is marked `INVALID`.

If *type_name* has a public synonym defined on it, then the database also drops the synonym.

Unless you specify `FORCE`, you can drop only types that are standalone schema objects with no dependencies. This is the default behavior.

 **See Also:**

Oracle Database SQL Language Reference for information about the `CREATE INDEXTYPE` statement

FORCE

Drops the type even if it has dependent database objects. The database marks `UNUSED` all columns dependent on the type to be dropped, and those columns become inaccessible.

 **Note:**

Oracle recommends against specifying `FORCE` to drop object types with dependencies. This operation is not recoverable and might make the data in the dependent tables or columns inaccessible.

VALIDATE

Causes the database to check for stored instances of this type in substitutable columns of any of its supertypes. If no such instances are found, then the database completes the drop operation.

This clause is meaningful only for subtypes. Oracle recommends the use of this option to safely drop subtypes that do not have any explicit type or table dependencies.

Example

Example 14-37 Dropping an ADT

This statement removes the ADT `person_t`. See "CREATE TYPE Statement" for the example that creates this ADT. Any columns that are dependent on `person_t` are marked `UNUSED` and become inaccessible.

```
DROP TYPE person_t FORCE;
```

Related Topics

- ["ALTER TYPE Statement"](#)
- ["CREATE TYPE Statement"](#)
- ["CREATE TYPE BODY Statement"](#)

14.21 DROP TYPE BODY Statement

The `DROP TYPE BODY` statement drops the body of an ADT, `VARRAY` type, or nested table type.

When you drop a type body, the type specification still exists, and you can re-create the type body. Prior to re-creating the body, you can still use the type, although you cannot invoke its member functions.

Topics

- [Prerequisites](#)
- [Syntax](#)
- [Semantics](#)
- [Example](#)
- [Related Topics](#)

Prerequisites

The type body must be in your schema or you must have the `DROP ANY TYPE` system privilege.

Syntax

drop_type_body ::=

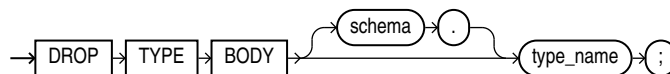

Semantics

schema

Name of the schema containing the type. **Default:** your schema.

type_name

Name of the type body to be dropped.

Restriction on *type_name*

You can drop a type body only if it has no type or table dependencies.

Example

Example 14-38 Dropping an ADT Body

This statement removes the ADT body `data_ttyp1`. See "[CREATE TYPE Statement](#)" for the example that creates this ADT.

```
DROP TYPE BODY data_ttyp1;
```

Related Topics

- "[ALTER TYPE Statement](#)"
- "[CREATE TYPE Statement](#)"
- "[CREATE TYPE BODY Statement](#)"

A

PL/SQL Source Text Wrapping

You can wrap the PL/SQL source text for any of these stored PL/SQL units, thereby preventing anyone from displaying that text with the static data dictionary views `*_SOURCE`:

- Package specification
- Package body
- Type specification
- Type body
- Function
- Procedure



Note:

Wrapping text is low-assurance security. For high-assurance security, use Oracle Database Vault, described in *Oracle Database Vault Administrator's Guide*.

A file containing wrapped PL/SQL source text is called a **wrapped file**. A wrapped file can be moved, backed up, or processed by SQL*Plus or the Import and Export utilities.

To produce a wrapped file, use either the PL/SQL Wrapper utility or a `DBMS_DDL` subprogram. The PL/SQL Wrapper utility wraps the source text of every wrappable PL/SQL unit created by a specified SQL file. The `DBMS_DDL` subprograms wrap the source text of single dynamically generated wrappable PL/SQL units.

Both the PL/SQL Wrapper utility and `DBMS_DDL` subprograms detect tokenization errors (for example, runaway strings), but not syntax or semantic errors (for example, nonexistent tables or views).

By default, the 12.2 PL/SQL compiler can use wrapped packages that were compiled with the 9.2 PL/SQL compiler. To prevent the 12.2 PL/SQL compiler from using wrapped packages that were compiled with the 9.2 PL/SQL compiler, set the PL/SQL compilation parameter `PERMIT_92_WRAP_FORMAT` to `FALSE`. For more information about `PERMIT_92_WRAP_FORMAT`, see *Oracle Database Reference*. For more information about PL/SQL compilation parameters, see "[PL/SQL Units and Compilation Parameters](#)".

Topics

- [PL/SQL Source Text Wrapping Limitations](#)
- [PL/SQL Source Text Wrapping Guidelines](#)
- [Wrapping PL/SQL Source Text with PL/SQL Wrapper Utility](#)
- [Wrapping PL/SQL Source Text with DBMS_DDL Subprograms](#)

A.1 PL/SQL Source Text Wrapping Limitations

- Wrapped files are not downward-compatible between Oracle Database releases.
For example, you cannot load files produced by the version $n.1$ PL/SQL Wrapper utility into a version $(n-1).2$ Oracle Database. Nor can you load files produced by the version $n.2$ PL/SQL Wrapper utility into a version $n.1$ Oracle Database. Wrapped files are both upward- and downward-compatible across patch sets.
- Wrapping PL/SQL source text is not a secure way to hide passwords or table names.
For high-assurance security, use Oracle Database Vault, described in *Oracle Database Vault Administrator's Guide*.
- You cannot wrap the PL/SQL source text of triggers.
To hide the implementation details of a trigger, put them in a stored subprogram, wrap the subprogram, and write a one-line trigger that invokes the subprogram.

A.2 PL/SQL Source Text Wrapping Guidelines

- Wrap only the body of a package or type, not the specification.
Leaving the specification unwrapped allows other developers to see the information needed to use the package or type (see [Example A-5](#)). Wrapping the body prevents them from seeing the package or type implementation.
- Wrap files only after you have finished editing them.
You cannot edit wrapped files. If a wrapped file needs changes, you must edit the original unwrapped file and then wrap it.
- Before distributing a wrapped file, view it in a text editor and ensure that all important parts are wrapped.

A.3 Wrapping PL/SQL Source Text with PL/SQL Wrapper Utility

The PL/SQL Wrapper utility takes a single SQL file (such as a SQL*Plus script) and produces an equivalent text file in which the PL/SQL source text of each wrappable PL/SQL unit is wrapped.

**Note:**

Oracle recommends using PL/SQL Wrapper Utility version 10 or later.

For the list of wrappable PL/SQL units, see the introduction to "[PL/SQL Source Text Wrapping](#)".

The PL/SQL Wrapper utility cannot connect to Oracle Database. To run the PL/SQL Wrapper utility, enter this command at the operating system prompt (with no spaces around the equal signs):

```
wrap iname=input_file [ oname=output_file ] [ keep_comments=yes ]
```

input_file is the name of an existing file that contains any combination of SQL statements. *output_file* is the name of the file that the PL/SQL Wrapper utility creates—the wrapped file.

**Note:**

input_file cannot include substitution variables specified with the SQL*Plus DEFINE notation, because *output_file* is parsed by the PL/SQL compiler, not by SQL*Plus.

The PL/SQL Wrapper utility deletes all comments from the wrapped file unless `keep_comments=yes` is specified. When `keep_comments=yes` is specified, only the comments outside the source are kept.

**Note:**

If *input_file* is a wrapped file, then *input_file* and *output_file* have identical contents.

The default file extension for *input_file* is `sql`. The default name of *output_file* is *input_file*.`plb`. Therefore, these commands are equivalent:

```
wrap iname=/mydir/myfile
wrap iname=/mydir/myfile.sql oname=/mydir/myfile.plb
```

This example specifies a different file extension for *input_file* and a different name for *output_file*:

```
wrap iname=/mydir/myfile.src oname=/yourdir/yourfile.out keep_comments=yes
```

You can run *output_file* as a script in SQL*Plus. For example:

```
SQL> @myfile.plb;
```

Example A-1 SQL File with Two Wrappable PL/SQL Units

This example shows the text of a SQL file, `wraptest2.sql`, that contains two wrappable PL/SQL units—the procedure `wraptest` and the function `fibonacci`. The file also contains comments and a SQL `SELECT` statement.

-- The following statement will not change.

```
SELECT COUNT(*) FROM EMPLOYEES
/
```

/* The PL/SQL source text of the following two CREATE statements will be wrapped. */

```
CREATE PROCEDURE wraptest AUTHID CURRENT_USER /* C style comment in procedure
declaration */ IS
  TYPE emp_tab IS TABLE OF employees%ROWTYPE INDEX BY PLS_INTEGER;
  all_emps emp_tab;
```

```

BEGIN
  SELECT * BULK COLLECT INTO all_emps FROM employees;
  FOR i IN 1..10 LOOP /* C style in pl/sql source */
    DBMS_OUTPUT.PUT_LINE('Emp Id: ' || all_emps(i).employee_id);
  END LOOP;
END;
/

CREATE OR REPLACE FUNCTION fibonacci (
  n PLS_INTEGER
) RETURN PLS_INTEGER
AUTHID CURRENT_USER -- PL/SQL style comment inside fibonacci function spec
IS
  fib_1 PLS_INTEGER := 0;
  fib_2 PLS_INTEGER := 1;
BEGIN
  IF n = 1 THEN -- terminating condition
    RETURN fib_1;
  ELSIF n = 2 THEN
    RETURN fib_2; -- terminating condition
  ELSE
    RETURN fibonacci(n-2) + fibonacci(n-1); -- recursive invocations
  END IF;
END;
/

```

Example A-2 Wrapping File with PL/SQL Wrapper Utility

This example uses the PL/SQL Wrapper utility to wrap `wrapptest2.sql` and shows the wrapped file, `wrapptest2.plb`. The wrapped file shows that the utility deleted the comments inside the code and wrapped (made unreadable) the PL/SQL source text of the procedure `wrapptest` and the function `fibonacci`, but kept the comments outside the wrapped source.

Assume that the operating system prompt is `>`. Wrap the file `wrapptest.sql`:

```
> wrap keep_comments=yes iname=wrapptest2.sql
```

Result:

```
Processing wrapptest2.sql to wrapptest2.plb
```

Contents of `wrapptest.plb`:

```

-- The following statement will not change.

SELECT COUNT(*) FROM EMPLOYEES
/

/* The PL/SQL source text of the following two CREATE statements will be
wrapped. */
CREATE OR REPLACE PROCEDURE wrapptest wrapped
a000000
1
abcd
abcd
abcd
abcd
abcd
abcd
abcd
abcd
abcd

```

```

abcd
abcd
abcd
abcd
abcd
abcd
abcd
abcd
abcd
7
129 138
qf4HggDBeNMP1WAsPn6pGf+2LGwwg+nwJK5qZ3SVWE4+GayDZaL1bF7RwYm2/zr1qjZY3FrN
48M1bKc/MG5aY9YB+DrtT4SjN370Rpq7ck5D0sc1D5sKAwTyX13HYvRmjwkdXa0vEZ4q/mCU
EQusX23UZbZjxha7Ct1CDCx8guGw/M/oHZXc8wDHXL8V80sqQMv/Hj7z68gIN170stalRScr
uSZ/l/W1YaaA9Lj8Fbx5/nJw96ZNY1SCY8VsB/G6O5f/65+EDxdThpnfU4e1vrrE9iB3/IpI
+7fE1Tv29fwc+aZq3S70

/

CREATE OR REPLACE FUNCTION fibonacci wrapped
a000000
1
abcd
abcd
abcd
abcd
abcd
abcd
abcd
abcd
abcd
abcd
abcd
abcd
abcd
abcd
abcd
abcd
abcd
abcd
abcd
8
150 ff
BFDvTL9OR04SJbx+q0y5H/h8IcwwgxDcAJnWZ3TNz51mjAmegdQcpNJfq8hUuQtv1Y5xg7Wd
KqMH/HBANhnZ+E1mBWeKavYjPx1qV9zIFqZAgB4SBqkqe42sai9Vb0cLEU02/ZCEyxDSfWf3
H1Lp6U9ztRXNy+oDZSNykwCULaZro0UmeFrNUBqzE6j9mI3AyRhPw1QbZX5oRMLgLOG30tS
SGJsz7M+bnhnp+xp4ww+SI1xx5LhDtnyPw==

/

```

Example A-3 Running Wrapped File and Viewing Wrapped PL/SQL Units

In SQL*Plus, this example runs the wrapped file `wrapptest.plb`, creating the procedure `wrapptest` and the function `fibonacci`; selects the text of the subprograms (which is wrapped and therefore unreadable), and then invokes the subprograms.

```

SQL> -- Run wrapped file:
SQL>
SQL> @wrapptest2.plb
SQL> -- The following statement will not change.
SQL>
SQL> SELECT COUNT(*) FROM EMPLOYEES
2 /

COUNT(*)
-----

```

107

1 row selected.

SQL> /* The PL/SQL source text of the following two CREATE statements will be wrapped. */

```
SQL> CREATE PROCEDURE wrapptest wrapped
  2  a000000
  3  1
  4  abcd
  5  abcd
  6  abcd
  7  abcd
  8  abcd
  9  abcd
 10  abcd
 11  abcd
 12  abcd
 13  abcd
 14  abcd
 15  abcd
 16  abcd
 17  abcd
 18  abcd
 19  7
 20 129 138
 21 qf4HggDBeNMP1WAsPn6pGf+2LGwwg+nwJK5qZ3SVWE4+GayDZaL1bF7RwYm2/zr1qjZY3FrN
 22 48M1bKc/MG5aY9YB+DrtT4SJN370Rpq7ck5D0sc1D5sKAwTyX13HYvRmjwkdXa0vEZ4q/mCU
 23 EQusX23UZbZjxha7Ct1CDCx8guGw/M/oHZXc8wDHXL8V8OsqQMv/Hj7z68gIN17OstalRScr
 24 uSZ/1/W1YaaA9Lj8Fbx5/nJw96ZNY1SCY8VsB/G605f/65+EDxdThpnfU4e1vrrE9iB3/IpI
 25 +7fE1Tv29fwc+aZq3S70
 26
 27 /
```

Procedure created.

```
SQL> CREATE OR REPLACE FUNCTION fibonacci wrapped
  2  a000000
  3  1
  4  abcd
  5  abcd
  6  abcd
  7  abcd
  8  abcd
  9  abcd
 10  abcd
 11  abcd
 12  abcd
 13  abcd
 14  abcd
 15  abcd
 16  abcd
 17  abcd
 18  abcd
 19  8
 20 150 ff
 21 BFDvTL9OR04SJbx+qOy5H/h8IcwwgxDcAJnWZ3TNz51mjAmegdQcpNJfq8hUuQtv1Y5xg7Wd
 22 KqMH/HBANhnZ+E1mEWekavYjPxlqV9zIFqZAgB4SBqkqe42sai9Vb0cLEU02/ZCEyxDSfWf3
 23 H1Lp6U9ztRXNy+oDZSNykWCUVLaZro0UmeFrNUBqzE6j9mI3AyRhPw1QbZX5oRMLgLOG3OtS
 24 SGJsz7M+bnhnp+xP4ww+SI1xx5LhDtntyPw==
```

25
26 /

Function created.

```
SQL>  
SQL> -- Try to display procedure source text:  
SQL>  
SQL> SELECT text FROM USER_SOURCE WHERE name='WRAPTEST';
```

TEXT

```
-----  
PROCEDURE wrapptest wrapped  
a000000  
1  
abcd  
abcd  
abcd  
abcd  
abcd  
abcd  
abcd  
abcd  
abcd  
abcd  
abcd  
abcd  
abcd  
abcd  
abcd  
abcd  
abcd  
7  
129 138  
qf4HggDBeNMP1WAsPn6pGf+2LGwgg+nwJK5qZ3SVWE4+GayDZaL1bF7RwYm2/zr1qjZY3FrN  
48M1bKc/MG5aY9YB+DrtT4SjN370Rpq7ck5D0sc1D5sKAwTyX13HYvRmjwkdXa0vEZ4q/mCU  
EQusX23UZbZjxha7Ct1CDCx8guGw/M/oHZXc8wDHXL8V8OsqQMv/Hj7z68gIN17OstalRScr  
uSZ/1/W1YaaA9Lj8Fbx5/nJw96ZNy1SCY8VsB/G6O5f/65+EDxdThpnfU4e1vrrE9iB3/IpI  
+7fE1Tv29fwc+aZq3S70
```

1 row selected.

```
SQL>  
SQL> -- Try to display function source text:  
SQL>  
SQL> SELECT text FROM USER_SOURCE WHERE name='FIBONACCI';
```

TEXT

```
-----  
FUNCTION fibonacci wrapped  
a000000  
1  
abcd  
abcd  
abcd  
abcd  
abcd  
abcd  
abcd  
abcd  
abcd  
abcd  
abcd  
abcd
```

```

abcd
abcd
abcd
abcd
abcd
abcd
8
150 ff
BFDvTL9OR04SJbx+qOy5H/h8IcwwgxDcAJnWZ3TNz51mjAmeqdQcpNJfq8hUuQtv1Y5xg7Wd
KqMH/HBANhnZ+E1mBWekavYjPx1qV9zIFqZAgB4SBqkqe42sai9Vb0cLEU02/ZCEyxDSfWf3
H1Lp6U9ztRXNy+oDZSNyKWCUVLaZro0UmeFrNUBqzE6j9mI3AyRhPw1QbZX5oRMLgLOG3OtS
SGJsz7M+bnhnp+xP4ww+SI1xx5LhDtnyPw==

1 row selected.

SQL>
SQL> BEGIN
  2   wraptest; -- invoke procedure
  3   DBMS_OUTPUT.PUT_LINE('fibonacci(5) = ' || fibonacci(5));
  4 END;
  5 /
Emp Id: 100
Emp Id: 101
Emp Id: 102
Emp Id: 103
Emp Id: 104
Emp Id: 105
Emp Id: 106
Emp Id: 107
Emp Id: 108
Emp Id: 109
fibonacci(5) = 3

PL/SQL procedure successfully completed.

SQL>

```

A.4 Wrapping PL/SQL Source Text with DBMS_DDL Subprograms

The `DBMS_DDL` package provides `WRAP` functions and `CREATE_WRAPPED` procedures, each of which wraps the PL/SQL source text of a single dynamically generated wrappable PL/SQL unit. The `DBMS_DDL` package also provides the exception `MALFORMED_WRAP_INPUT` (ORA-24230), which is raised if the input to `WRAP` or `CREATE_WRAPPED` is not a valid wrappable PL/SQL unit. (For the list of wrappable PL/SQL units, see the introduction to ["PL/SQL Source Text Wrapping"](#).)

Each `WRAP` function takes as input a single `CREATE` statement that creates a wrappable PL/SQL unit and returns an equivalent `CREATE` statement in which the PL/SQL source text is wrapped. For more information about the `WRAP` functions, see *Oracle Database PL/SQL Packages and Types Reference*.

 **Caution:**

If you pass the statement that `DBMS_DDL.WRAP` returns to the `DBMS_SQL.PARSE` procedure whose formal parameter `statement` has data type `VARCHAR2A`, then you must set the `lfflg` parameter of `DBMS_SQL.PARSE` to `FALSE`. Otherwise, `DBMS_SQL.PARSE` adds lines to the wrapped PL/SQL unit, corrupting it. (For the syntax of `DBMS_SQL.PARSE`, see *Oracle Database PL/SQL Packages and Types Reference*.)

Each `CREATE_WRAPPED` procedure does what its corresponding `WRAP` function does and then runs the returned `CREATE` statement, creating the specified PL/SQL unit. For more information about the `CREATE_WRAPPED` procedures, see *Oracle Database PL/SQL Packages and Types Reference*.

 **Tip:**

When invoking a `DBMS_DDL` subprogram, use the fully qualified package name, `SYS.DBMS_DDL`, to avoid name conflict if someone creates a local package named `DBMS_DDL` or defines the public synonym `DBMS_DDL`.

 **Note:**

The `CREATE` statement that is input to a `WRAP` function or `CREATE_WRAPPED` procedure runs with the privileges of the user who invoked the subprogram.

[Example A-4](#) dynamically creates a package specification (using the `EXECUTE IMMEDIATE` statement) and a wrapped package body, using a `CREATE_WRAPPED` procedure.

[Example A-5](#) selects the text of the package that [Example A-4](#) created, `emp_actions`, and then invokes the procedure `emp_actions.raise_salary`. If the package specification were wrapped, then the information needed to invoke the procedure would be unreadable, like the PL/SQL source text of the package body.

Example A-4 Creating Wrapped Package Body with `CREATE_WRAPPED` Procedure

```

DECLARE
    package_text VARCHAR2(32767); -- text for creating package spec and body

    FUNCTION generate_spec (pkgname VARCHAR2) RETURN VARCHAR2 AS
    BEGIN
        RETURN 'CREATE PACKAGE ' || pkgname || ' AUTHID CURRENT_USER AS
            PROCEDURE raise_salary (emp_id NUMBER, amount NUMBER);
            PROCEDURE fire_employee (emp_id NUMBER);
            END ' || pkgname || ' ';
    END generate_spec;

    FUNCTION generate_body (pkgname VARCHAR2) RETURN VARCHAR2 AS
    BEGIN
        RETURN 'CREATE PACKAGE BODY ' || pkgname || ' AS

```

```

PROCEDURE raise_salary (emp_id NUMBER, amount NUMBER) IS
BEGIN
    UPDATE employees
        SET salary = salary + amount WHERE employee_id = emp_id;
END raise_salary;
PROCEDURE fire_employee (emp_id NUMBER) IS
BEGIN
    DELETE FROM employees WHERE employee_id = emp_id;
END fire_employee;
END ' || pkgname || ';';
END generate_body;

BEGIN
    package_text := generate_spec('emp_actions'); -- Generate package spec
    EXECUTE IMMEDIATE package_text;             -- Create package spec
    package_text := generate_body('emp_actions'); -- Generate package body
    SYS.DBMS_DDL.CREATE_WRAPPED(package_text);   -- Create wrapped package body
END;
/

```

Example A-5 Viewing Package with Wrapped Body and Invoking Package Procedure

Select text of package:

```
SELECT text FROM USER_SOURCE WHERE name = 'EMP_ACTIONS';
```

Result:

TEXT

```

-----
PACKAGE emp_actions AUTHID CURRENT_USER AS
    PROCEDURE raise_salary (emp_id NUMBER, amount NUMBER);
    PROCEDURE fire_employee (emp_id NUMBER);
    END emp_actions;
PACKAGE BODY emp_actions wrapped
a000000
1f
abcd
abcd
abcd
abcd
abcd
abcd
abcd
abcd
abcd
abcd
abcd
abcd
abcd
abcd
abcd
abcd
abcd
abcd
abcd
b
180 113
1fOVodewm7j9dB0mBsiEQz0BKCgwg/BKoZ4VZy/pTBIYo8Uj1sjpbEz08Ck3HMjYq/Mf0XZn
u9D0Kd+i89g9Z061I6vZYjw2AuBidnLESyR63LH2pFD/7lyDTfF1eDY5vmNwLTxrFaxGy243
0lHKAzm0lwwfBWylkZZNi2UnpmSIE6z/BU2nhbwfpqd224p69FwYVXmFX2H5IMsdZ2/vWsK9
cDMCD1KEqOnPpbU2yXdpW3GIbGD8JFIbKAfpJLkoLfVxoRPXQfj0h1k=

```

Invoke raised_salary and show its effect:

```
DECLARE
  s employees.salary%TYPE;
BEGIN
  SELECT salary INTO s FROM employees WHERE employee_id=130;
  DBMS_OUTPUT.PUT_LINE('Old salary: ' || s);
  emp_actions.raise_salary(130, 100);
  SELECT salary INTO s FROM employees WHERE employee_id=130;
  DBMS_OUTPUT.PUT_LINE('New salary: ' || s);
END;
/
```

Result:

```
Old salary: 3557.4
New salary: 3657.4
```

PL/SQL procedure successfully completed.

B

PL/SQL Name Resolution

This appendix explains PL/SQL **name resolution**; that is, how the PL/SQL compiler resolves ambiguous references to identifiers.

An unambiguous identifier reference can become ambiguous if you change identifiers in its compilation unit (that is, if you add, rename, or delete identifiers).



Note:

The `AUTHID` property of a stored PL/SQL unit affects the name resolution of SQL statements that the unit issues at run time. For more information, see "[Invoker's Rights and Definer's Rights \(AUTHID Property\)](#)".

Topics

- [Qualified Names and Dot Notation](#)
- [Column Name Precedence](#)
- [Differences Between PL/SQL and SQL Name Resolution Rules](#)
- [Resolution of Names in Static SQL Statements](#)
- [What is Capture?](#)
- [Avoiding Inner Capture in SELECT and DML Statements](#)

B.1 Qualified Names and Dot Notation

When one named item belongs to another named item, you can (and sometimes must) qualify the name of the "child" item with the name of the "parent" item, using dot notation. For example:

When referencing ...	You must qualify its name with ...	Using this syntax ...
Field of a record	Name of the record	<code>record_name.field_name</code>
Method of a collection	Name of the collection	<code>collection_name.method</code>
Pseudocolumn <code>CURRVAL</code>	Name of a sequence	<code>sequence_name.CURRVAL</code>
Pseudocolumn <code>NEXTVAL</code>	Name of a sequence	<code>sequence_name.NEXTVAL</code>

If an identifier is declared in a named PL/SQL unit, you can qualify its simple name (the name in its declaration) with the name of the unit (block, subprogram, or package), using this syntax:

```
unit_name.simple_identifier_name
```

If the identifier is not visible, then you *must* qualify its name (see "[Scope and Visibility of Identifiers](#)").

If an identifier belongs to another schema, then you must qualify its name with the name of the schema, using this syntax:

```
schema_name.package_name
```

A simple name can be qualified with multiple names, as [Example B-1](#) shows.

Some examples of possibly ambiguous qualified names are:

- Field or attribute of a function return value, for example:

```
func_name().field_name
func_name().attribute_name
```

- Schema object owned by another schema, for example:

```
schema_name.table_name
schema_name.procedure_name()
schema_name.type_name.member_name()
```

- Package object owned by another user, for example:

```
schema_name.package_name.procedure_name()
schema_name.package_name.record_name.field_name
```

- Record containing an ADT, for example:

```
record_name.field_name.attribute_name
record_name.field_name.member_name()
```

Example B-1 Qualified Names

```
CREATE OR REPLACE PACKAGE pkg1 AUTHID DEFINER AS
  m NUMBER;
  TYPE t1 IS RECORD (a NUMBER);
  v1 t1;
  TYPE t2 IS TABLE OF t1 INDEX BY PLS_INTEGER;
  v2 t2;
  FUNCTION f1 (p1 NUMBER) RETURN t1;
  FUNCTION f2 (q1 NUMBER) RETURN t2;
END pkg1;
/

CREATE OR REPLACE PACKAGE BODY pkg1 AS
  FUNCTION f1 (p1 NUMBER) RETURN t1 IS
    n NUMBER;
  BEGIN
    n := m;           -- Unqualified variable name
    n := pkg1.m;     -- Variable name qualified by package name
    n := pkg1.f1.p1; -- Parameter name qualified by function name,
                    -- which is qualified by package name
    n := v1.a;       -- Variable name followed by component name
    n := pkg1.v1.a;  -- Variable name qualified by package name
                    -- and followed by component name
    n := v2(10).a;   -- Indexed name followed by component name
    n := f1(10).a;   -- Function invocation followed by component name
    n := f2(10)(10).a; -- Function invocation followed by indexed name
                    -- and followed by component name
    n := hr.pkg1.f2(10)(10).a; -- Schema name, package name,
                    -- function invocation, index, component name
  v1.a := p1;
```

```

    RETURN v1;
END f1;

FUNCTION f2 (q1 NUMBER) RETURN t2 IS
    v_t1 t1;
    v_t2 t2;
BEGIN
    v_t1.a := q1;
    v_t2(1) := v_t1;
    RETURN v_t2;
END f2;
END pkg1;
/

```

B.2 Column Name Precedence

If a SQL statement references a name that belongs to both a column and either a local variable or formal parameter, then the column name takes precedence.

▲ Caution:

When a variable or parameter name is interpreted as a column name, data can be deleted, changed, or inserted unintentionally.

In [Example B-2](#), the name `last_name` belongs to both a local variable and a column (names are not case-sensitive). Therefore, in the `WHERE` clause, both references to `last_name` resolve to the column, and all rows are deleted.

[Example B-3](#) solves the problem in [Example B-2](#) by giving the variable a different name.

[Example B-4](#) solves the problem in [Example B-2](#) by labeling the block and qualifying the variable name with the block name.

In [Example B-5](#), the function `dept_name` has a formal parameter and a local variable whose names are those of columns of the table `DEPARTMENTS`. The parameter and variable name are qualified with the function name to distinguish them from the column names.

Example B-2 Variable Name Interpreted as Column Name Causes Unintended Result

```

DROP TABLE employees2;
CREATE TABLE employees2 AS
    SELECT LAST_NAME FROM employees;

DECLARE
    last_name VARCHAR2(10) := 'King';
BEGIN
    DELETE FROM employees2 WHERE LAST_NAME = last_name;
    DBMS_OUTPUT.PUT_LINE('Deleted ' || SQL%ROWCOUNT || ' rows. ');
END;
/

```

Result:

Deleted 107 rows.

Example B-3 Fixing Example B-2 with Different Variable Name

```
DECLARE
  v_last_name VARCHAR2(10) := 'King';
BEGIN
  DELETE FROM employees2 WHERE LAST_NAME = v_last_name;
  DBMS_OUTPUT.PUT_LINE('Deleted ' || SQL%ROWCOUNT || ' rows.');
```

Result:

Deleted 2 rows.

Example B-4 Fixing Example B-2 with Block Label

```
<<main>>
DECLARE
  last_name VARCHAR2(10) := 'King';
BEGIN
  DELETE FROM employees2 WHERE last_name = main.last_name;
  DBMS_OUTPUT.PUT_LINE('Deleted ' || SQL%ROWCOUNT || ' rows.');
```

Result:

Deleted 2 rows.

Example B-5 Subprogram Name for Name Resolution

```
DECLARE
  FUNCTION dept_name (department_id IN NUMBER)
    RETURN departments.department_name%TYPE
  IS
    department_name departments.department_name%TYPE;
  BEGIN
    SELECT department_name INTO dept_name.department_name
      -- ^column          ^local variable
    FROM departments
    WHERE department_id = dept_name.department_id;
    -- ^column          ^formal parameter
    RETURN department_name;
  END dept_name;
  BEGIN
    FOR item IN (
      SELECT department_id
      FROM departments
      ORDER BY department_name) LOOP

      DBMS_OUTPUT.PUT_LINE ('Department: ' || dept_name(item.department_id));
    END LOOP;
  END;
```

Result:

Department: Accounting
Department: Administration

```
Department: Benefits
Department: Construction
Department: Contracting
Department: Control And Credit
Department: Corporate Tax
Department: Executive
Department: Finance
Department: Government Sales
Department: Human Resources
Department: IT
Department: IT Helpdesk
Department: IT Support
Department: Manufacturing
Department: Marketing
Department: NOC
Department: Operations
Department: Payroll
Department: Public Relations
Department: Purchasing
Department: Recruiting
Department: Retail Sales
Department: Sales
Department: Shareholder Services
Department: Shipping
Department: Treasury
```

B.3 Differences Between PL/SQL and SQL Name Resolution Rules

PL/SQL and SQL name resolution rules are very similar. However:

- PL/SQL rules are less permissive than SQL rules.

Because most SQL rules are context-sensitive, they recognize as legal more situations than PL/SQL rules do.

- PL/SQL and SQL resolve qualified names differently.

For example, when resolving the table name `HR.JOBS`:

- PL/SQL searches first for packages, types, tables, and views named `HR` in the current schema, then for public synonyms, and finally for objects named `JOBS` in the `HR` schema.
- SQL searches first for objects named `JOBS` in the `HR` schema, and then for packages, types, tables, and views named `HR` in the current schema.

To avoid problems caused by the few differences between PL/SQL and SQL name resolution rules, follow the recommendations in "[Avoiding Inner Capture in SELECT and DML Statements](#)".

Note:

When the PL/SQL compiler processes a static SQL statement, it sends that statement to the SQL subsystem, which uses SQL rules to resolve names in the statement. For details, see "[Resolution of Names in Static SQL Statements](#)".

B.4 Resolution of Names in Static SQL Statements

Static SQL is described in [PL/SQL Static SQL](#).

When the PL/SQL compiler finds a static SQL statement:

1. If the statement is a `SELECT` statement, the PL/SQL compiler removes the `INTO` clause.
2. The PL/SQL compiler sends the statement to the SQL subsystem.
3. The SQL subsystem checks the syntax of the statement.

If the syntax is incorrect, the compilation of the PL/SQL unit fails. If the syntax is correct, the SQL subsystem determines the names of the tables and tries to resolve the other names in the scope of the SQL statement.

4. If the SQL subsystem cannot resolve a name in the scope of the SQL statement, then it sends the name back to the PL/SQL compiler. The name is called an **escaped identifier**.
5. The PL/SQL compiler tries to resolve the escaped identifier.

First, the compiler tries to resolve the identifier in the scope of the PL/SQL unit. If that fails, the compiler tries to resolve the identifier in the scope of the schema. If that fails, the compilation of the PL/SQL unit fails.

6. If the compilation of the PL/SQL unit succeeds, the PL/SQL compiler generates the text of the regular SQL statement that is equivalent to the static SQL statement and stores that text with the generated computer code.
7. At run time, the PL/SQL runtime system invokes routines that parse, bind, and run the regular SQL statement.

The bind variables are the escaped identifiers (see step 4).

8. If the statement is a `SELECT` statement, the PL/SQL runtime system stores the results in the PL/SQL targets specified in the `INTO` clause that the PL/SQL compiler removed in step 1.

Note:

Bind variables can be evaluated in any order. If a program determines order of evaluation, then at the point where the program does so, its behavior is undefined.

B.5 What is Capture?

When a declaration or definition prevents the compiler from correctly resolving a reference in another scope, the declaration or definition is said to **capture** the reference. Capture is usually the result of migration or schema evolution.

Topics

- [Outer Capture](#)

- Same-Scope Capture
- Inner Capture

**Note:**

Same-scope and inner capture occur only in SQL scope.

B.5.1 Outer Capture

Outer capture occurs when a name in an inner scope, which had resolved to an item in an inner scope, now resolves to an item in an outer scope. Both PL/SQL and SQL are designed to prevent outer capture; you need not be careful to avoid it.

B.5.2 Same-Scope Capture

Same-scope capture occurs when a column is added to one of two tables used in a join, and the new column has the same name as a column in the other table. When only one table had a column with that name, the name could appear in the join unqualified. Now, to avoid same-scope capture, you must qualify the column name with the appropriate table name, everywhere that the column name appears in the join.

B.5.3 Inner Capture

Inner capture occurs when a name in an inner scope, which had resolved to an item in an outer scope, now either resolves to an item in an inner scope or cannot be resolved. In the first case, the result might change. In the second case, an error occurs.

In [Example B-6](#), a new column captures a reference to an old column with the same name. Before new column `col2` is added to table `tab2`, `col2` resolves to `tab1.col2`; afterward, it resolves to `tab2.col2`.

To avoid inner capture, follow the rules in "[Avoiding Inner Capture in SELECT and DML Statements](#)".

Example B-6 Inner Capture of Column Reference

Table `tab1` has a column named `col2`, but table `tab2` does not:

```
DROP TABLE tab1;
CREATE TABLE tab1 (col1 NUMBER, col2 NUMBER);
INSERT INTO tab1 (col1, col2) VALUES (100, 10);
```

```
DROP TABLE tab2;
CREATE TABLE tab2 (col1 NUMBER);
INSERT INTO tab2 (col1) VALUES (100);
```

Therefore, in the inner `SELECT` statement, the reference to `col2` resolves to column `tab1.col2`:

```
CREATE OR REPLACE PROCEDURE proc AUTHID DEFINER AS
  CURSOR c1 IS
    SELECT * FROM tab1
    WHERE EXISTS (SELECT * FROM tab2 WHERE col2 = 10);
```



```
BEGIN
  OPEN c1;
  CLOSE c1;
END;
/
```

Add a column named `col2` to table `tab2`:

```
ALTER TABLE tab2 ADD (col2 NUMBER);
```

Now procedure `proc` is invalid. At its next invocation, the database automatically recompiles it, and the reference to `col2` in the inner `SELECT` statement resolves to column `tab2.col2`.

B.6 Avoiding Inner Capture in SELECT and DML Statements

Avoid inner capture of references in `SELECT`, `SELECT INTO`, and DML statements by following these recommendations:

- Specify a unique alias for each table in the statement.
- Do not specify a table alias that is the name of a schema that owns an item referenced in the statement.
- Qualify each column reference in the statement with the appropriate table alias.

In [Example B-7](#), schema `hr` owns tables `tab1` and `tab2`. Table `tab1` has a column named `tab2`, whose Abstract Data Type (ADT) has attribute `a`. Table `tab2` does not have a column named `a`. Against recommendation, the query specifies alias `hr` for table `tab1` and references table `tab2`. Therefore, in the query, the reference `hr.tab2.a` resolves to table `tab1`, column `tab2`, attribute `a`. Then the example adds column `a` to table `tab2`. Now the reference `hr.tab2.a` in the query resolves to schema `hr`, table `tab2`, column `a`. Column `a` of table `tab2` captures the reference to attribute `a` in column `tab2` of table `tab1`.

Topics

- [Qualifying References to Attributes and Methods](#)
- [Qualifying References to Row Expressions](#)

Example B-7 Inner Capture of Attribute Reference

```
CREATE OR REPLACE TYPE type1 AS OBJECT (a NUMBER);
/
DROP TABLE tab1;
CREATE TABLE tab1 (tab2 type1);
INSERT INTO tab1 (tab2) VALUES (type1(10));

DROP TABLE tab2;
CREATE TABLE tab2 (x NUMBER);
INSERT INTO tab2 (x) VALUES (10);

/* Alias tab1 with same name as schema name,
   a bad practice used here for illustration purpose.
   Note lack of alias in second SELECT statement. */
```

```
SELECT * FROM tab1 hr
WHERE EXISTS (SELECT * FROM hr.tab2 WHERE x = hr.tab2.a);
```

Result:

```
TAB2 (A)
-----

TYPE1 (10)

1 row selected.
```

Add a column named a to table tab2 (which belongs to schema hr):

```
ALTER TABLE tab2 ADD (a NUMBER);
```

Now, when the query runs, hr.tab2.a resolves to schema hr, table tab2, column a. To avoid this inner capture, apply the recommendations to the query:

```
SELECT * FROM hr.tab1 p1
WHERE EXISTS (SELECT * FROM hr.tab2 p2 WHERE p2.x = p1.tab2.a);
```

B.6.1 Qualifying References to Attributes and Methods

To reference an attribute or method of a table element, you must give the table an alias and use the alias to qualify the reference to the attribute or method.

In [Example B-8](#), table tb1 has column col1 of data type t1, an ADT with attribute x. The example shows several correct and incorrect references to tb1.col1.x.

Example B-8 Qualifying ADT Attribute References

```
CREATE OR REPLACE TYPE t1 AS OBJECT (x NUMBER);
/
DROP TABLE tb1;
CREATE TABLE tb1 (col1 t1);
```

The references in the following INSERT statements do not need aliases, because they have no column lists:

```
BEGIN
  INSERT INTO tb1 VALUES ( t1(10) );
  INSERT INTO tb1 VALUES ( t1(20) );
  INSERT INTO tb1 VALUES ( t1(30) );
END;
/
```

The following references to the attribute x cause error ORA-00904:

```
UPDATE tb1 SET col1.x = 10 WHERE col1.x = 20;

UPDATE tb1 SET tb1.col1.x = 10 WHERE tb1.col1.x = 20;

UPDATE hr.tb1 SET hr.tb1.col1.x = 10 WHERE hr.tb1.col1.x = 20;

DELETE FROM tb1 WHERE tb1.col1.x = 10;
```

The following references to the attribute x, with table aliases, are correct:

```
UPDATE hr.tb1 t SET t.col1.x = 10 WHERE t.col1.x = 20;
```

```

DECLARE
  y NUMBER;
BEGIN
  SELECT t.col1.x INTO y FROM tb1 t WHERE t.col1.x = 30;
END;
/

DELETE FROM tb1 t WHERE t.col1.x = 10;

```

B.6.2 Qualifying References to Row Expressions

Row expressions must resolve as references to table aliases. A row expression can appear in the SET clause of an UPDATE statement or be the parameter of the SQL function REF or VALUE.

In [Example B-9](#), table ot1 is a standalone nested table of elements of data type t1, an ADT with attribute x. The example shows several correct and incorrect references to row expressions.

Example B-9 Qualifying References to Row Expressions

```

CREATE OR REPLACE TYPE t1 AS OBJECT (x number);
/
DROP TABLE ot1;
CREATE TABLE ot1 OF t1;

BEGIN
  INSERT INTO ot1 VALUES (t1(10));
  INSERT INTO ot1 VALUES (20);
  INSERT INTO ot1 VALUES (30);
END;
/

```

The following references cause error ORA-00904:

```

UPDATE ot1 SET VALUE(ot1.x) = t1(20) WHERE VALUE(ot1.x) = t1(10);

DELETE FROM ot1 WHERE VALUE(ot1) = (t1(10));

```

The following references, with table aliases, are correct:

```

UPDATE ot1 o SET o = (t1(20)) WHERE o.x = 10;

DECLARE
  n_ref REF t1;
BEGIN
  SELECT REF(o) INTO n_ref FROM ot1 o WHERE VALUE(o) = t1(30);
END;
/

DECLARE
  n t1;
BEGIN
  SELECT VALUE(o) INTO n FROM ot1 o WHERE VALUE(o) = t1(30);
END;
/

DECLARE
  n NUMBER;

```

```
BEGIN
  SELECT o.x INTO n FROM ot1 o WHERE o.x = 30;
END;
/

DELETE FROM ot1 o WHERE VALUE(o) = (t1(20));
```

C

PL/SQL Program Limits

This appendix describes the program limits that are imposed by the PL/SQL language. PL/SQL is based on the programming language Ada. As a result, PL/SQL uses a variant of Descriptive Intermediate Attributed Notation for Ada (DIANA), a tree-structured intermediate language. It is defined using a metanotation called Interface Definition Language (IDL). DIANA is used internally by compilers and other tools.

At compile time, PL/SQL source text is translated into system code. Both the DIANA and system code for a subprogram or package are stored in the database. At run time, they are loaded into the shared memory pool. The DIANA is used to compile dependent subprograms; the system code simply runs.

In the shared memory pool, a package specification, ADT specification, standalone subprogram, or anonymous block is limited to 67108864 (2^{26}) DIANA nodes which correspond to tokens such as identifiers, keywords, operators, and so on. This allows for ~6,000,000 lines of code unless you exceed limits imposed by the PL/SQL compiler, some of which are given in [Table C-1](#).

Table C-1 PL/SQL Compiler Limits

Item	Limit
bind variables passed to a program unit	32768
exception handlers in a program unit	65536
fields in a record	65536
levels of block nesting	255
levels of record nesting	32
levels of subquery nesting	254
levels of label nesting	98
levels of nested collections	no predefined limit
magnitude of a <code>PLS_INTEGER</code> or <code>BINARY_INTEGER</code> value	-2147483648..2147483647
number of formal parameters in an explicit cursor, function, or procedure	65536
objects referenced by a program unit	65536
precision of a <code>FLOAT</code> value (binary digits)	126
precision of a <code>NUMBER</code> value (decimal digits)	38
precision of a <code>REAL</code> value (binary digits)	63
size of an identifier (bytes)	128
size of a string literal (bytes)	32767
size of a <code>CHAR</code> value (bytes)	32767
size of a <code>LONG</code> value (bytes)	32760
size of a <code>LONG RAW</code> value (bytes)	32760

Table C-1 (Cont.) PL/SQL Compiler Limits

Item	Limit
size of a RAW value (bytes)	32767
size of a VARCHAR2 value (bytes)	32767
size of an NCHAR value (bytes)	32767
size of an NVARCHAR2 value (bytes)	32767
size of a BFILE value (bytes)	4G * value of DB_BLOCK_SIZE parameter
size of a BLOB value (bytes)	4G * value of DB_BLOCK_SIZE parameter
size of a CLOB value (bytes)	4G * value of DB_BLOCK_SIZE parameter
size of an NCLOB value (bytes)	4G * value of DB_BLOCK_SIZE parameter
size of a trigger	32 K

To estimate how much memory a program unit requires, you can query the static data dictionary view `USER_OBJECT_SIZE`. The column `PARSED_SIZE` returns the size (in bytes) of the "flattened" DIANA. For example:

```
CREATE OR REPLACE PACKAGE pkg1 AS
  TYPE numset_t IS TABLE OF NUMBER;
  FUNCTION f1(x NUMBER) RETURN numset_t PIPELINED;
END pkg1;
/

CREATE PACKAGE BODY pkg1 AS
  -- FUNCTION f1 returns a collection of elements (1,2,3,... x)
  FUNCTION f1(x NUMBER) RETURN numset_t PIPELINED IS
  BEGIN
    FOR i IN 1..x LOOP
      PIPE ROW(i);
    END LOOP;
    RETURN;
  END f1;
END pkg1;
/
```

SQL*Plus commands for formatting results of next query:

```
COLUMN name FORMAT A4
COLUMN type FORMAT A12
COLUMN source_size FORMAT 999
COLUMN parsed_size FORMAT 999
COLUMN code_size FORMAT 999
COLUMN error_size FORMAT 999
```

Query:

```
SELECT * FROM user_object_size WHERE name = 'PKG1' ORDER BY type;
```

Result:

NAME	TYPE	SOURCE_SIZE	PARSED_SIZE	CODE_SIZE	ERROR_SIZE
PKG1	PACKAGE	112	498	310	79
PKG1	PACKAGE BODY	233	106	334	0

Unfortunately, you cannot estimate the number of DIANA nodes from the parsed size. Two program units with the same parsed size might require 1500 and 2000 DIANA nodes, respectively because, for example, the second unit contains more complex SQL statements.

When a PL/SQL block, subprogram, package, or schema-level user-defined type exceeds a size limit, you get an error such as `PLS-00123: program too large`. Typically, this problem occurs with packages or anonymous blocks. With a package, the best solution is to divide it into smaller packages. With an anonymous block, the best solution is to redefine it as a group of subprograms, which can be stored in the database.

For more information about the limits on data types, see [PL/SQL Data Types](#).

D

PL/SQL Reserved Words and Keywords

Reserved words (listed in [Table D-1](#)) and **keywords** (listed in [Table D-2](#)) are identifiers that have special meaning in PL/SQL. They are case-insensitive. For more information about them, see "[Reserved Words and Keywords](#)".



Note:

Some of the words in this appendix are also reserved by SQL. You can display them with the dynamic performance view `V$RESERVED_WORDS`. For information about this view, see *Oracle Database Reference*.

Table D-1 PL/SQL Reserved Words

Begins with:	Reserved Words
A	ALL, ALTER, AND, ANY, AS, ASC, AT
B	BEGIN, BETWEEN, BY
C	CASE, CHECK, CLUSTERS, CLUSTER, COLAUTH, COLUMNS, COMPRESS, CONNECT, CRASH, CREATE, CURSOR
D	DECLARE, DEFAULT, DESC, DISTINCT, DROP
E	ELSE, END, EXCEPTION, EXCLUSIVE
F	FETCH, FOR, FROM, FUNCTION
G	GOTO, GRANT, GROUP
H	HAVING
I	IDENTIFIED, IF, IN, INDEX, INDEXES, INSERT, INTERSECT, INTO, IS
L	LIKE, LOCK
M	MINUS, MODE
N	NOCOMPRESS, NOT, NOWAIT, NULL
O	OF, ON, OPTION, OR, ORDER, OVERLAPS
P	PROCEDURE, PUBLIC
R	RESOURCE, REVOKE
S	SELECT, SHARE, SIZE, SQL, START, SUBTYPE
T	TABAUTH, TABLE, THEN, TO, TYPE
U	UNION, UNIQUE, UPDATE
V	VALUES, VIEW, VIEWS
W	WHEN, WHERE, WITH

Table D-2 PL/SQL Keywords

Begins with:	Keywords
A	A, ADD, ACCESSIBLE, AGENT, AGGREGATE, ARRAY, ATTRIBUTE, AUTHID, AVG
B	BFILE_BASE, BINARY, BLOB_BASE, BLOCK, BODY, BOTH, BOUND, BULK, BYTE
C	C, CALL, CALLING, CASCADE, CHAR, CHAR_BASE, CHARACTER, CHARSET, CHARSETFORM, CHARSETID, CLOB_BASE, CLONE, CLOSE, COLLECT, COMMENT, COMMIT, COMMITTED, COMPILED, CONSTANT, CONSTRUCTOR, CONTEXT, CONTINUE, CONVERT, COUNT, CREDENTIAL, CURRENT, CUSTOMDATUM
D	DANGLING, DATA, DATE, DATE_BASE, DAY, DEFINE, DELETE, DETERMINISTIC, DIRECTORY, DOUBLE, DURATION
E	ELEMENT, ELSIF, EMPTY, ESCAPE, EXCEPT, EXCEPTIONS, EXECUTE, EXISTS, EXIT, EXTERNAL
F	FINAL, FIRST, FIXED, FLOAT, FORALL, FORCE
G	GENERAL
H	HASH, HEAP, HIDDEN, HOUR
I	IMMEDIATE, INCLUDING, INDICATOR, INDICES, INFINITE, INSTANTIABLE, INT, INTERFACE, INTERVAL, INVALIDATE, ISOLATION
J	JAVA
L	LANGUAGE, LARGE, LEADING, LENGTH, LEVEL, LIBRARY, LIKE2, LIKE4, LIKEC, LIMIT, LIMITED, LOCAL, LONG, LOOP
M	MAP, MAX, MAXLEN, MEMBER, MERGE, MIN, MINUTE, MOD, MODIFY, MONTH, MULTISSET
N	NAME, NAN, NATIONAL, NATIVE, NCHAR, NEW, NOCOPY, NUMBER_BASE
O	OBJECT, OCICOLL, OCIDATE, OCIDATETIME, OCIDURATION, OCIINTERVAL, OCIOBLOCATOR, OCINUMBER, OCIRAW, OCIREF, OCIREFCURSOR, OCIROWID, OCISTRING, OCITYPE, OLD, ONLY, OPAQUE, OPEN, OPERATOR, ORACLE, ORADATA, ORGANIZATION, ORLANY, ORLVARY, OTHERS, OUT, OVERRIDING
P	PACKAGE, PARALLEL_ENABLE, PARAMETER, PARAMETERS, PARENT, PARTITION, PASCAL, PERSISTABLE, PIPE, PIPELINED, PLUGGABLE, POLYMORPHIC, PRAGMA, PRECISION, PRIOR, PRIVATE
R	RAISE, RANGE, RAW, READ, RECORD, REF, REFERENCE, RELIES_ON, REM, REMAINDER, RENAME, RESULT, RESULT_CACHE, RETURN, RETURNING, REVERSE, ROLLBACK, ROW
S	SAMPLE, SAVE, SAVEPOINT, SB1, SB2, SB4, SECOND, SEGMENT, SELF, SEPARATE, SEQUENCE, SERIALIZABLE, SET, SHORT, SIZE_T, SOME, SPARSE, SQLCODE, SQLDATA, SQLNAME, SQLSTATE, STANDARD, STATIC, STDDEV, STORED, STRING, STRUCT, STYLE, SUBMULTISSET, SUBPARTITION, SUBSTITUTABLE, SUM, SYNONYM
T	TDO, THE, TIME, TIMESTAMP, TIMEZONE_ABBR, TIMEZONE_HOUR, TIMEZONE_MINUTE, TIMEZONE_REGION, TRAILING, TRANSACTION, TRANSACTIONAL, TRUSTED
U	UB1, UB2, UB4, UNDER, UNPLUG, UNSIGNED, UNTRUSTED, USE, USING
V	VALIST, VALUE, VARIABLE, VARIANCE, VARRAY, VARYING, VOID
W	WHILE, WORK, WRAPPED, WRITE
Y	YEAR
Z	ZONE

E

PL/SQL Predefined Data Types

This appendix groups by data type family the data types and subtypes that the package STANDARD predefines.

Constants

This constant defines the maximum name length possible.

```
ORA_MAX_NAME_LEN CONSTANT PLS_INTEGER := 128;
```

BFILE Data Type Family

```
type BFILE is BFILE_BASE;
```

BLOB Data Type Family

```
type BLOB is BLOB_BASE;
```

```
subtype "BINARY LARGE OBJECT" is BLOB;
```

BOOLEAN Data Type Family

```
type BOOLEAN is (FALSE, TRUE);
```

CHAR Data Type Family

```
type VARCHAR2 is new CHAR_BASE;
```

```
type MLSLABEL is new CHAR_BASE;
```

```
type UROWID is new CHAR_BASE;
```

DBMS_ID and DBMS_QUOTED_ID define the length of identifiers in objects for SQL, PL/SQL and users.

```
subtype DBMS_ID is VARCHAR2(ORA_MAX_NAME_LEN);
```

```
subtype DBMS_QUOTED_ID is VARCHAR2(ORA_MAX_NAME_LEN+2);
```

DBMS_ID_30 and DBMS_QUOTED_ID_30 define the length of SQL objects whose limits is 30 bytes.

```
subtype DBMS_ID_30 is VARCHAR2(30);
```

```
subtype DBMS_QUOTED_ID_30 is VARCHAR2(32);
```

```
subtype VARCHAR is VARCHAR2;
```

```
subtype STRING is VARCHAR2;
```

```
subtype LONG is VARCHAR2(32760);
```

```
subtype RAW is VARCHAR2;
```

```
subtype "LONG RAW" is RAW(32760);
```

```
subtype ROWID is VARCHAR2(256);
```

```
subtype CHAR is VARCHAR2;
```

```
subtype CHARACTER is CHAR;
```

```
subtype "CHARACTER VARYING" is VARCHAR;
```

```
subtype "CHAR VARYING" is VARCHAR;
```

```
subtype "NATIONAL CHARACTER" is CHAR CHARACTER SET NCHAR_CS;
```

```
subtype "NATIONAL CHAR" is CHAR CHARACTER SET NCHAR_CS;
```

```

subtype "NCHAR"                is CHAR CHARACTER SET NCHAR_CS;
subtype "NVARCHAR2"            is VARCHAR2 CHARACTER SET NCHAR_CS;

```

CLOB Data Type Family

```

type CLOB is CLOB_BASE;

subtype "CHARACTER LARGE OBJECT"    is CLOB;
subtype "CHAR LARGE OBJECT"         is CLOB;
subtype "NATIONAL CHARACTER LARGE OBJECT" is CLOB CHARACTER SET NCHAR_CS;
subtype "NCHAR LARGE OBJECT"        is CLOB CHARACTER SET NCHAR_CS;
subtype "NCLOB"                     is CLOB CHARACTER SET NCHAR_CS;

```

DATE Data Type Family

```

type DATE is DATE_BASE;

type TIMESTAMP is new DATE_BASE;

type "TIMESTAMP WITH TIME ZONE"      is new DATE_BASE;
type "INTERVAL YEAR TO MONTH"        is new DATE_BASE;
type "INTERVAL DAY TO SECOND"        is new DATE_BASE;
type "TIMESTAMP WITH LOCAL TIME ZONE" is new DATE_BASE;

subtype TIME_UNCONSTRAINED           is TIME(9);
subtype TIME_TZ_UNCONSTRAINED        is TIME(9) WITH TIME ZONE;
subtype TIMESTAMP_UNCONSTRAINED      is TIMESTAMP(9);
subtype TIMESTAMP_TZ_UNCONSTRAINED   is TIMESTAMP(9) WITH TIME ZONE;
subtype YMININTERVAL_UNCONSTRAINED   is INTERVAL YEAR(9) TO MONTH;
subtype DSINTERVAL_UNCONSTRAINED     is INTERVAL DAY(9) TO SECOND (9);
subtype TIMESTAMP_LTZ_UNCONSTRAINED  is TIMESTAMP(9) WITH LOCAL TIME ZONE;

```

NUMBER Data Type Family

```

type NUMBER is NUMBER_BASE;

subtype FLOAT is NUMBER; -- NUMBER(126)
subtype REAL is FLOAT; -- FLOAT(63)
subtype "DOUBLE PRECISION" is FLOAT;

subtype INTEGER is NUMBER(38,0);
subtype INT is INTEGER;
subtype SMALLINT is NUMBER(38,0);

subtype DECIMAL is NUMBER(38,0);
subtype NUMERIC is DECIMAL;
subtype DEC is DECIMAL;

subtype BINARY_INTEGER is INTEGER range '-2147483647'..2147483647;
subtype NATURAL is BINARY_INTEGER range 0..2147483647;
subtype NATURALN is NATURAL not null;
subtype POSITIVE is BINARY_INTEGER range 1..2147483647;
subtype POSITIVEN is POSITIVE not null;
subtype SIGNTYPE is BINARY_INTEGER range '-1'..1; -- for SIGN functions
subtype PLS_INTEGER is BINARY_INTEGER;

type BINARY_FLOAT is NUMBER;
type BINARY_DOUBLE is NUMBER;

subtype SIMPLE_INTEGER is BINARY_INTEGER NOT NULL;

```

```
subtype SIMPLE_FLOAT is BINARY_FLOAT NOT NULL;  
subtype SIMPLE_DOUBLE is BINARY_DOUBLE NOT NULL;
```

 **See Also:**

- [PL/SQL Data Types](#) for more information about PL/SQL data types
- ["User-Defined PL/SQL Subtypes"](#) for information that also applies to predefined subtypes

Index

Symbols

- _ wildcard character, [2-40](#)
- % wildcard character, [2-40](#)
- %BULK_EXCEPTIONS cursor attribute, [12-21](#)
- %BULK_ROWCOUNT cursor attribute, [12-24](#)
- %FOUND cursor attribute
 - for implicit cursor, [6-7](#)
 - for named cursor, [6-22](#)
- %ISOPEN cursor attribute
 - for implicit cursor, [6-7](#)
 - for named cursor, [6-21](#)
- %NOTFOUND cursor attribute
 - for implicit cursor, [6-8](#)
 - for named cursor, [6-23](#)
- %ROWCOUNT cursor attribute
 - for implicit cursor, [6-8](#)
 - for named cursor, [6-23](#)
- %ROWTYPE attribute, [5-53](#)
 - column alias and, [6-15](#)
 - explicit cursor and, [6-15](#)
 - invisible columns and, [5-57](#)
 - syntax diagram, [13-147](#)
 - virtual columns and, [5-56](#)
- %TYPE attribute, [2-19](#)
 - initial value and, [2-19](#)
 - NOT NULL constraint and, [2-19](#)
 - syntax diagram, [13-160](#)
- \$\$PLSQL_LINE inquiry directive, [2-57](#)
- \$\$PLSQL_UNIT inquiry directive, [2-57](#)
- \$\$PLSQL_UNIT_OWNER inquiry directive, [2-57](#)
- \$\$PLSQL_UNIT_TYPE inquiry directive, [2-57](#)

A

- Abstract Data Type (ADT), [1-8](#), [14-13](#)
 - creating, [14-65](#)
- accent-insensitive comparison, [2-39](#)
- ACCESS_INTO_NULL exception, [11-11](#)
- ACCESSIBLE BY clause, [10-1](#), [13-3](#)
 - in CREATE FUNCTION statement, [14-25](#)
 - in CREATE PACKAGE statement, [14-35](#)
 - in CREATE PROCEDURE statement, [14-42](#)
 - in CREATE TYPE BODY statement, [14-76](#)
 - in CREATE TYPE statement, [14-65](#)

- ACCESSIBLE BY clause (*continued*)
 - in package specification, [10-1](#)
 - in subprogram, [8-2](#)
- accessor, [13-3](#)
- accessor list, [13-3](#)
- ADT
 - See Abstract Data Type (ADT)
- aggregate, [5-17](#)
- AGGREGATE clause, [13-8](#)
 - in CREATE FUNCTION statement, [14-25](#)
- aggregate function, [14-25](#)
 - in PL/SQL expression, [2-47](#)
 - pipelined table function as, [12-47](#)
 - SQL%NOTFOUND attribute and, [6-8](#)
- alias
 - column
 - in cursor FOR LOOP, [6-26](#)
 - in explicit cursor, [6-15](#)
 - table
 - for avoiding inner capture, [B-8](#)
 - for row expression, [B-10](#)
 - for table element attribute or method, [B-9](#)
- aliasing (problem)
 - SELECT BULK COLLECT INTO statement
 - and, [12-28](#)
 - subprogram parameter, [8-20](#)
 - ALTER FUNCTION statement, [14-2](#)
 - ALTER LIBRARY statement, [14-4](#)
 - ALTER PACKAGE statement, [14-6](#)
 - ALTER PROCEDURE statement, [14-8](#)
 - ALTER TRIGGER statement, [14-10](#)
 - ALTER TYPE statement, [14-13](#)
- AND operator, [2-32](#)
- anonymous block, [1-4](#)
 - AUTHID property and, [8-50](#)
- ANYDATA data type, [12-43](#)
- ANYDATASET data type, [12-43](#)
- ANYTYPE data type, [12-43](#)
- application common object
 - metadata-linked, [13-153](#)
- architecture of PL/SQL, [1-10](#)
- array
 - associative
 - See associative array, [5-2](#)
 - non-PL/SQL, [5-2](#)

assignment of value
 to composite variable
 collection, [5-20](#)
 record, [5-58](#)
 to scalar variable, [2-25](#)
 assignment statement, [2-26](#)
 syntax diagram, [13-9](#)
 associative array, [5-4](#)
 characteristics of, [5-2](#)
 comparisons, [5-25](#)
 declaring constant, [5-6](#)
 FIRST and LAST methods for, [5-37](#)
 in FORALL statement, [13-103](#)
 NLS parameters and, [5-8](#)
 See also collection
 atomic (lexical) unit, [2-4](#)
 atomically null collection
 See null collection
 attribute
 %ROWTYPE
 See %ROWTYPE attribute, [5-53](#)
 %TYPE
 See %TYPE attribute, [2-19](#)
 cursor
 See cursor attribute, [6-5](#)
 AUTHID property, [8-50](#)
 syntax diagram, [13-117](#)
 autonomous routine, [6-55](#)
 declaring, [6-57](#)
 autonomous transaction, [6-55](#)
 controlling, [6-59](#)
 pipelined table function in, [13-129](#)
 autonomous trigger, [6-60](#)
 AUTONOMOUS_TRANSACTION pragma, [6-57](#)
 for pipelined table function, [12-43](#)
 syntax diagram, [13-12](#)

B

bag data structure, [5-2](#)
 base type, [3-1](#)
 basic LOOP statement, [4-10](#)
 syntax diagram, [13-13](#)
 BETWEEN operator, [2-42](#)
 BINARY_DOUBLE data type
 predefined constants for, [3-3](#)
 subtype of, [3-3](#)
 tuning code and, [12-9](#)
 BINARY_FLOAT data type
 predefined constants for, [3-3](#)
 subtype of, [3-3](#)
 tuning code and, [12-9](#)
 BINARY_INTEGER data type
 See PLS_INTEGER data type

bind variable
 avoiding SQL injection with, [7-23](#)
 placeholder for
 See placeholder for bind variable, [7-2](#)
 blank-padding
 in assignment, [3-6](#)
 in comparison, [3-7](#)
 block, [1-4](#)
 syntax diagram, [13-14](#)
 BOOLEAN data type, [3-8](#)
 BOOLEAN expression, [2-43](#)
 BOOLEAN static expression, [2-52](#)
 BOOLEAN variable, [2-28](#)
 built-in function
 See SQL function
 bulk binding, [12-12](#)
 BULK COLLECT clause, [12-26](#), [12-38](#)
 aliasing and, [12-28](#)
 of FETCH statement, [12-34](#)
 of RETURNING INTO clause
 FORALL statement and, [12-39](#)
 of SELECT INTO statement, [12-26](#)
 query result set processing and, [6-26](#)
 that returns no rows, [12-26](#)
 bulk SQL, [12-12](#)
 in compound DML trigger, [9-12](#)

C

C declaration, [13-23](#)
 C procedure, invoking, [8-53](#)
 cache, function result, [8-37](#)
 calculated column
 See virtual column
 call specification, [8-53](#)
 in CREATE FUNCTION statement, [14-25](#)
 in CREATE PROCEDURE statement, [14-42](#)
 in CREATE TYPE statement, [14-65](#)
 in package, [10-1](#)
 syntax diagram, [13-23](#)
 call stack, AUTHID property and, [8-50](#)
 capture, [B-6](#)
 cascading triggers, [9-46](#)
 CASE expression
 searched, [2-46](#)
 simple, [2-44](#)
 case sensitivity
 character comparison and, [2-39](#)
 character literal and, [2-10](#)
 identifier and, [2-6](#)
 quoted user-defined identifier, [2-8](#)
 keyword and, [D-1](#)
 LIKE operator and, [2-40](#)
 reserved word and, [D-1](#)

- CASE statement, [4-1](#)
 - searched, [4-8](#)
 - syntax diagram, [13-26](#)
 - simple, [4-7](#)
 - IF THEN ELSIF statement and, [4-5](#)
 - syntax diagram, [13-26](#)
- CASE_NOT_FOUND exception, [11-11](#)
- case-insensitive comparison, [2-39](#)
- CHAR data type, [3-4](#)
- CHAR data type family, [E-1](#)
- character code, [2-1](#)
- character literal, [2-10](#)
 - See *also* string
- character set, [2-1](#)
- CLOB data type and comparison operator, [2-37](#)
- CLOB data type family, [E-1](#)
- CLOSE statement, [13-29](#)
- collating sequence, [2-39](#)
- collation, [13-54](#)
- collection, [5-1](#), [5-4](#), [5-10](#), [5-12](#)
 - as public package item, [5-46](#)
 - assigning one to another, [5-20](#)
 - comparing one to another, [5-25](#)
 - cursor variable and, [13-50](#)
 - declaration syntax, [13-33](#)
 - empty, [5-2](#)
 - creating with constructor, [5-16](#)
 - index
 - See index collection, [12-16](#)
 - internal size of
 - DELETE method and, [5-30](#)
 - EXTEND method and, [5-35](#)
 - TRIM method and, [5-33](#)
 - multidimensional, [5-23](#)
 - null, [5-2](#)
 - assigning to collection variable, [5-21](#)
 - pipelined table function and, [12-42](#)
 - querying
 - with dynamic SQL, [7-8](#)
 - with static SQL, [6-38](#)
 - retrieving query results into, [12-26](#)
 - types of, [5-2](#)
- collection constructor, [5-16](#)
- collection method, [5-29](#)
 - as subprogram parameter, [5-29](#)
 - invocation syntax, [13-30](#)
 - null collection and, [5-29](#)
- COLLECTION_IS_NULL exception, [11-11](#)
- column alias
 - in cursor FOR LOOP, [6-26](#)
 - in explicit cursor, [6-15](#)
- COLUMNS pseudo-operator, [12-56](#)
- comment, [2-13](#)
 - nested, [2-14](#)
 - PL/SQL Wrapper utility and, [A-2](#)
- comment (*continued*)
 - syntax diagram, [13-38](#)
- COMMIT statement, [6-45](#)
 - FOR UPDATE cursor and, [6-53](#)
 - in autonomous transaction, [6-59](#)
- comparison operator, [2-37](#)
 - cursor variable and, [13-50](#)
- compatible data type
 - for collection variables, [5-20](#)
 - for scalar variables, [2-25](#)
- compilation
 - conditional, [2-55](#)
 - for native execution, [12-70](#)
 - interpreted, [12-72](#)
- compilation parameter, [1-11](#)
 - displaying value of, [2-57](#)
 - predefined inquiry directive for, [2-57](#)
- compile clause, [13-39](#)
- compile_clause
 - in ALTER FUNCTION statement, [14-2](#)
- compile_clause syntax diagram, [13-39](#)
- compile-time warning, [11-2](#)
- compiler directive
 - See pragma
- composite data type, [5-1](#)
- composite variable, [5-1](#)
- compound trigger, [9-10](#)
- computation-intensive code, [12-9](#)
- concatenation operator (||), [2-29](#)
- concurrent transactions, [6-60](#)
- condition, SQL multiset, [5-28](#)
- conditional compilation, [2-55](#)
- conditional compilation directive, [2-55](#)
 - error, [2-57](#)
 - inquiry, [2-57](#)
 - restrictions on, [2-63](#)
 - selection, [2-56](#)
- conditional predicate, [9-5](#)
- conditional selection statement, [4-1](#)
- conditional trigger, [9-1](#)
- constant
 - declaring, [2-17](#)
 - associative array, [5-6](#)
 - record, [5-48](#)
 - syntax diagram, [13-42](#)
 - initial value of, [2-17](#)
 - predefined, [3-3](#)
 - static, [2-53](#)
 - in DBMS_DB_VERSION package, [2-61](#)
- constrained subtype, [3-15](#)
 - in performance-critical code, [12-10](#)
 - subprogram parameter and, [8-12](#)
- constraint
 - cursor parameter and, [13-83](#)

- constraint (*continued*)
 - NOT NULL
 - See NOT NULL constraint, [2-15](#)
 - trigger compared to, [9-3](#)
 - constructor
 - See collection constructor
 - context of transaction, [6-57](#)
 - CONTINUE statement, [4-13](#)
 - syntax diagram, [13-43](#)
 - CONTINUE WHEN statement, [4-14](#)
 - syntax diagram, [13-43](#)
 - control statement, [4-1](#)
 - control token, [2-56](#)
 - correlated subquery, [6-29](#)
 - correlation name, [9-28](#)
 - with LONG or LONG RAW column, [9-42](#)
 - See also pseudorecord
 - COUNT collection method, [5-41](#)
 - COVERAGE pragma, [13-45](#)
 - CREATE FUNCTION statement, [14-25](#)
 - CREATE LIBRARY statement, [14-31](#)
 - CREATE PACKAGE statement, [14-35](#)
 - CREATE TRIGGER statement, [14-45](#)
 - CREATE TYPE BODY statement, [14-76](#)
 - CREATE TYPE statement, [14-65](#)
 - CREATE_WRAPPED procedure, [A-8](#)
 - crossedition trigger, [9-1](#)
 - CURRENT OF clause, [6-53](#)
 - FOR UPDATE cursor and, [6-53](#)
 - ROWID pseudocolumn instead of, [6-53](#)
 - CURRVAL pseudocolumn, [6-4](#)
 - cursor, [6-5](#)
 - explicit
 - See explicit cursor, [6-9](#)
 - FOR UPDATE, [6-53](#)
 - after COMMIT or ROLLBACK, [6-53](#)
 - implicit
 - See implicit cursor, [6-7](#)
 - in SERIALY_REUSEABLE package, [10-9](#)
 - named, [6-9](#)
 - pipelined table function and, [12-47](#)
 - See also explicit cursor and cursor variable, [6-9](#)
 - nested, [6-43](#)
 - cursor attribute
 - for cursor variable, [6-39](#)
 - for explicit cursor, [6-20](#)
 - %FOUND, [6-22](#)
 - %ISOPEN, [6-21](#)
 - %NOTFOUND, [6-23](#)
 - %ROWCOUNT, [6-23](#)
 - for implicit cursor, [6-7](#)
 - DBMS_SQL package and, [7-11](#)
 - native dynamic SQL and, [7-2](#)
 - SQL%BULK_EXCEPTIONS, [12-21](#)
 - cursor attribute (*continued*)
 - for implicit cursor (*continued*)
 - SQL%BULK_ROWCOUNT, [12-24](#)
 - SQL%FOUND, [6-7](#)
 - SQL%ISOPEN, [6-7](#)
 - SQL%NOTFOUND, [6-8](#)
 - SQL%ROWCOUNT, [6-8](#)
 - where you can use, [6-5](#)
 - CURSOR expression, [6-43](#)
 - passing to pipelined table function, [12-47](#)
 - cursor FOR LOOP statement, [4-15](#)
 - query result set processing with, [6-26](#)
 - recursive invocation in, [8-35](#)
 - syntax diagram, [13-48](#)
 - cursor number
 - converting cursor variable to, [7-16](#)
 - converting to cursor variable, [7-15](#)
 - DBMS_SQL.GET_NEXT_RESULT procedure and, [7-13](#)
 - DBMS_SQL.RETURN_RESULT procedure and, [7-12](#)
 - cursor parameter, [6-16](#)
 - cursor specification, [13-83](#)
 - cursor variable, [6-30](#), [6-32](#)
 - converting cursor number to, [7-15](#)
 - converting to cursor number, [7-16](#)
 - DBMS_SQL.GET_NEXT_RESULT procedure and, [7-13](#)
 - DBMS_SQL.RETURN_RESULT procedure and, [7-12](#)
 - declaration syntax diagram, [13-50](#)
 - CURSOR_ALREADY_OPEN exception, [11-11](#)
- ## D
-
- data abstraction, [1-7](#)
 - data definition language statement
 - See DDL statement
 - Data Pump Import and triggers, [9-48](#)
 - data type, [3-1](#)
 - collection
 - See collection, [5-1](#)
 - compatible
 - for collection variables, [5-20](#)
 - for scalar variables, [2-25](#)
 - composite, [5-1](#)
 - object
 - See Abstract Data Type (ADT), [1-8](#)
 - of expression, [2-28](#)
 - predefined, [E-1](#)
 - RECORD
 - See record, [5-1](#)
 - scalar, [3-1](#)
 - SQL, [3-2](#)

- data type (*continued*)
 - user-defined
 - See Abstract Data Type (ADT), [1-8](#)
 - what it determines, [3-1](#)
 - See also subtype
- data type conversion, [3-2](#)
 - implicit
 - See implicit data type conversion, [12-10](#)
 - SQL injection and, [7-21](#)
- data type family, [3-1](#)
 - overloaded subprogram and, [8-30](#)
 - predefined data types grouped by, [E-1](#)
 - subtypes with base types in same, [3-17](#)
- Data-bound collation, [13-54](#)
- database character set, [2-1](#)
- database links
 - DR units, [8-53](#)
- DATABASE trigger, [9-35](#)
- datatype
 - in CREATE TYPE statement, [14-65](#)
- Datatype, [13-53](#)
- DATE data type family, [E-1](#)
- DBMS_ASSERT package, [7-25](#)
- DBMS_DB_VERSION package, [2-61](#)
- DBMS_DDL package, [A-8](#)
- DBMS_PARALLEL_EXECUTE package, [12-67](#)
- DBMS_PREPROCESSOR package, [2-63](#)
- DBMS_SQL package, [7-11](#)
 - switching to native dynamic SQL from, [7-11](#)
- DBMS_SQL.GET_NEXT_RESULT procedure, [7-13](#)
- DBMS_SQL.RETURN_RESULT procedure, [7-12](#)
- DBMS_SQL.TO_NUMBER function, [7-16](#)
- DBMS_SQL.TO_REFCURSOR function, [7-15](#)
- DBMS_STANDARD package, [2-20](#)
- DBMS_WARNING package, [11-4](#)
- dbmsupgin.sql script, [12-72](#)
- dbmsupgnv.sql script, [12-72](#)
- DDL statement, [6-60](#)
 - dynamic SQL for, [7-1](#)
 - in trigger, [6-60](#)
 - subprogram side effects and, [8-49](#)
- deadlock
 - autonomous transaction and, [6-60](#)
 - implicit rollback and, [6-50](#)
- declaration, [2-15](#)
 - exception raised in, [11-22](#)
- DEFAULT COLLATION clause, [13-54](#)
 - in CREATE FUNCTION statement, [14-25](#)
 - in CREATE PACKAGE statement, [14-35](#)
 - in CREATE PROCEDURE statement, [14-42](#)
 - in CREATE TRIGGER statement, [14-45](#)
 - in CREATE TYPE statement, [14-65](#)
- default value, [8-23](#)
 - of cursor parameter, [6-18](#)
- default value (*continued*)
 - of subprogram parameter, [8-23](#)
 - See also initial value
- DEFINE
 - binding category, [12-12](#)
- definer's rights clause, [13-117](#)
- definer's rights unit
 - See DR unit
- DELETE collection method, [5-30](#)
 - COUNT method and, [5-41](#)
 - EXISTS method and, [5-36](#)
 - EXTEND method and, [5-35](#)
 - FIRST method and, [5-37](#)
 - LAST method and, [5-37](#)
 - NEXT method and, [5-44](#)
 - PRIOR method and, [5-44](#)
 - TRIM method and, [5-33](#)
- DELETE statement, [13-56](#)
 - BEFORE statement trigger and, [9-39](#)
 - PL/SQL extension to, [13-56](#)
 - See also DML statement
- DELETING conditional predicate, [9-5](#)
- delimiter, [2-4](#)
- dense collection, [5-2](#)
- DEPRECATE pragma, [13-56](#)
- Descriptive Intermediate Attributed Notation for Ada (DIANA), [C-1](#)
- DETERMINISTIC
 - in CREATE FUNCTION statement, [14-25](#)
- DETERMINISTIC clause, [13-66](#)
- DETERMINISTIC option, [13-108](#)
 - for pipelined table function, [12-43](#)
- DIAGNOSTIC_DEST initialization parameter, [11-1](#)
- direct-key partitioning, [14-25](#), [14-76](#)
- directive, [2-55](#)
 - compiler
 - See pragma, [2-12](#)
 - error, [2-57](#)
 - inquiry, [2-57](#)
 - selection, [2-56](#)
 - See also conditional compilation directive
- DML statement, [13-56](#), [13-118](#), [13-162](#)
 - avoiding inner capture in, [B-8](#)
 - in FORALL statement, [12-13](#)
 - inside pipelined table function, [12-43](#)
 - on pipelined table function result, [12-50](#)
 - PL/SQL syntax of, [6-1](#)
 - repeating efficiently, [12-13](#)
- DML trigger, [9-4](#)
- dot notation, [2-20](#)
 - for collection method, [5-29](#)
 - for identifier in named PL/SQL unit, [2-20](#)
 - for pseudocolumn, [6-4](#)
 - for record field, [5-1](#)

dot notation (*continued*)
 name resolution and, [B-1](#)
 double quotation mark ("), [2-1](#)
 DR unit, [8-50](#)
 call stack and, [8-50](#)
 database links, [8-53](#)
 dynamic SQL and, [8-50](#)
 INHERIT REMOTE PRIVILEGES privilege,
[8-53](#)
 name resolution and, [8-50](#)
 privilege checking and, [8-50](#)
 SCHEMA trigger and, [9-34](#)
 static SQL and, [8-50](#)
See also AUTHID property
 DROP FUNCTION statement, [14-80](#)
 DROP LIBRARY statement, [14-82](#)
 DROP PACKAGE statement, [14-83](#)
 DROP PROCEDURE statement, [14-85](#)
 DROP TRIGGER statement, [14-86](#)
 DROP TYPE BODY statement, [14-89](#)
 DUP_VAL_ON_INDEX exception, [11-11](#)
 dynamic SQL, [7-1](#)
 AUTHID property and, [8-50](#)
 native, [7-2](#)
 switching to DBMS_SQL package from,
[7-11](#)
 placeholder for bind variable in
 EXECUTE IMMEDIATE statement and,
[7-2](#)
 repeated, [7-9](#)
 tuning, [12-4](#)

E

editioned, [14-13](#)
 editioned Abstract Data Type (ADT), [14-13](#)
 element of collection, [5-1](#)
 element specification
 in CREATE TYPE statement, [14-65](#)
 syntax diagram, [13-68](#)
 embedded SQL
See static SQL
 empty collection, [5-2](#)
 creating with constructor, [5-16](#)
 error directive, [2-57](#)
 error handling, [11-1](#)
 error-reporting function
 SQLCODE, [13-155](#)
 SQLERRM, [13-156](#)
 SQL%BULK_EXCEPTIONS and, [12-21](#)
 escape character, [2-40](#)
 escaped identifier, [B-6](#)
 evaluation order, [2-30](#)
 events publication, [9-49](#)
 evolution of type, [14-13](#)

exception, [11-1](#)
 handling, [11-5](#)
 in FORALL statement, [12-19](#)
 in trigger, [9-38](#)
See also exception handler, [11-5](#)
 internally defined
See internally defined exception, [11-10](#)
 predefined
See predefined exception, [11-11](#)
 raised in cursor FOR LOOP statement, [6-26](#)
 raised in declaration, [11-22](#)
 raised in exception handler, [11-23](#)
 raising explicitly, [11-16](#)
 reraising, [11-17](#)
 unhandled, [11-27](#)
 in FORALL statement, [12-19](#)
 user-defined
See user-defined exception, [11-14](#)
 exception handler, [11-5](#)
 continuing execution after, [11-28](#)
 exception raised in, [11-23](#)
 for NO_DATA_NEEDED, [12-51](#)
 GOTO statement and, [13-111](#)
 locator variables for, [11-7](#)
 retrieving error code and message in, [11-27](#)
 retrying transaction after, [11-30](#)
 syntax diagram, [13-76](#)
 EXCEPTION_INIT pragma, [13-74](#)
 for giving error code to user-defined
 exception, [11-18](#)
 for giving name to internally defined
 exception, [11-10](#)
 EXECUTE IMMEDIATE statement, [7-2](#)
 syntax diagram, [13-78](#)
 EXISTS collection method, [5-36](#)
 EXIT statement, [4-10](#)
 syntax diagram, [13-81](#)
 EXIT WHEN statement, [4-11](#)
 in basic LOOP statement, [4-11](#)
 syntax diagram, [13-81](#)
 exiting a loop, [4-9](#)
 explicit cursor, [6-9](#)
 declaration syntax diagram, [13-83](#)
 in package
 declaring, [10-12](#)
 opening and closing, [10-11](#)
 query result processing with
 in FOR LOOP statement, [6-26](#)
 with OPEN, FETCH, and CLOSE
 statements, [6-29](#)
 explicit format model, [7-26](#)
 expression, [2-28](#)
 CURSOR, [6-43](#)
 passing to pipelined table function, [12-47](#)
 data type of, [2-28](#)

expression (*continued*)
 in explicit cursor, [6-15](#)
 SQL function in PL/SQL, [2-47](#)
 static, [2-48](#)
 syntax diagram, [13-86](#)

EXTEND collection method, [5-35](#)

external subprogram, [8-53](#)
 call specification, [13-23](#)

F

FETCH FIRST clause, [12-33](#)

FETCH statement
 across COMMIT, [6-53](#)
 record variable and, [5-62](#)
 syntax diagram, [13-99](#)
 that returns no row, [6-11](#)
 with BULK COLLECT clause, [12-34](#)
 with cursor variable, [6-34](#)
 with explicit cursor, [6-11](#)

field of record, [5-1](#)

FIRST collection method, [5-37](#)

FOR LOOP statement, [4-15](#)
 bounds of, [4-19](#)
 FORALL statement and, [12-13](#)
 STEP clause and, [4-15](#)
 syntax diagram, [13-101](#)
See also cursor FOR LOOP statement

FOR UPDATE cursor, [6-53](#)
 after COMMIT or ROLLBACK, [6-53](#)

FORALL statement, [12-13](#)
 associative array in, [13-103](#)
 bulk binding and, [12-12](#)
 BULK COLLECT clause and, [12-39](#)
 for sparse collection, [12-16](#)
 SQL%BULK_EXCEPTIONS and, [12-23](#)
 handling exception raised in
 after FORALL completes, [12-21](#)
 immediately, [12-19](#)
 number of rows affected by, [12-24](#)
 syntax diagram, [13-103](#)
 unhandled exception in, [12-19](#)

format model, [7-26](#)

forward declaration of subprogram, [8-9](#)

function, [8-1](#)
 aggregate
See aggregate function, [12-47](#)
 built-in
See SQL function, [12-11](#)
 declaration syntax diagram, [13-108](#)
 error-reporting
 SQLCODE, [13-155](#)
 SQLERRM, [12-21](#)
 invoking, [8-2](#)
 in SQL statement, [8-49](#)

function (*continued*)
 options for, [8-5](#)
 SQL
See SQL function, [12-11](#)
 structure of, [8-5](#)
 table
See table function, [12-42](#)
See also subprogram

function result cache, [8-37](#)

function specification, [13-108](#)

G

generated column
See virtual column

GET_NEXT_RESULT procedure, [7-13](#)

global identifier, [2-21](#)

GOTO statement, [4-23](#)
 restrictions on, [13-111](#)
 syntax diagram, [13-111](#)

granting roles to PL/SQL units, [8-52](#)

H

hardware arithmetic, [12-9](#)

hash table, [5-2](#)

hiding PL/SQL source text
See wrapping PL/SQL source text

host variable
 bulk-binding, [12-41](#)
 cursor variable as, [6-42](#)
 packages and, [10-2](#)

I

identifier, [2-6](#), [2-20](#)
 ambiguous reference to, [B-1](#)
 escaped, [B-6](#)
 global, [2-21](#)
 in static SQL, [6-1](#)
 local, [2-21](#)
 reference to, [2-20](#)
 scope of, [2-21](#)
 user-defined, [2-7](#)
 collecting data about, [12-68](#)
 visibility of, [2-21](#)
See also name

IDL, [C-1](#)

IF statement, [4-1](#)
 IF THEN ELSE form, [4-3](#)
 IF THEN ELSIF form, [4-5](#)
 nested IF THEN ELSE statement and,
[4-5](#)
 simple CASE statement and, [4-5](#)
 IF THEN form, [4-2](#)

- IF statement (*continued*)
- nested, [4-3](#)
 - syntax diagram, [13-112](#)
- imp and triggers, [9-48](#)
- implicit cursor, [6-7](#)
- CURSOR expression with, [6-43](#)
 - declaration syntax, [13-113](#)
 - dynamic SQL and, [7-11](#)
 - query result processing with
 - with cursor FOR LOOP statement, [6-26](#)
 - with SELECT INTO statement, [6-25](#)
- implicit data type conversion
- minimizing, [12-10](#)
 - of subprogram parameter, [8-14](#)
 - causing overload error, [8-33](#)
 - of subtypes
 - constrained, [3-15](#)
 - unconstrained, [3-14](#)
 - with base types in same family, [3-17](#)
- implicit ROLLBACK statement, [6-50](#)
- implicitly returning query results, [7-12](#)
- Import and triggers, [9-48](#)
- IN operator, [2-42](#)
- IN OUT parameter mode, [8-15](#)
- IN parameter mode, [8-15](#)
- in-bind, [12-12](#)
- independent transaction
- See autonomous transaction
- index collection, [12-16](#)
- representing subset with, [12-16](#)
- index of collection, [5-1](#)
- index-by table
- See associative array
- infinite loop, [4-10](#)
- INFORMATIONAL compile-time warning, [11-2](#)
- INHERIT ANY PRIVILEGES privilege, [8-50](#)
- INHERIT PRIVILEGES privilege, [8-50](#)
- INHERIT REMOTE PRIVILEGES privilege, [8-53](#)
- initial value, [8-23](#)
- %TYPE attribute and, [2-19](#)
 - NOT NULL constraint and, [2-15](#)
 - of constant, [2-17](#)
 - of variable
 - nested table, [5-12](#)
 - record, [5-48](#)
 - scalar, [2-17](#)
 - varray, [5-10](#)
 - See also default value
- initialization parameter, [1-11](#)
- INLINE pragma, [12-2](#)
- syntax diagram, [13-115](#)
- inner capture, [B-7](#)
- avoiding, [B-8](#)
- input, [1-6](#)
- inquiry directive, [2-57](#)
- INSERT statement, [13-118](#)
- inserting record with, [5-65](#)
 - restrictions on, [5-67](#)
 - PL/SQL extension to, [13-118](#)
 - See also DML statement
- INSERTING conditional predicate, [9-5](#)
- INSTEAD OF trigger, [9-1](#)
- for CREATE statement, [9-36](#)
 - on DML statement, [9-6](#)
 - compound, [9-11](#)
 - for pipelined table function result, [12-50](#)
 - on nested table column, [9-6](#)
- Interface Definition Language (IDL), [C-1](#)
- internally defined exception, [11-10](#)
- giving name to, [11-10](#)
 - raising explicitly, [11-17](#)
- interpreted compilation, [12-72](#)
- INVALID_CURSOR exception, [11-11](#)
- INVALID_NUMBER exception, [11-11](#)
- invisible column, [5-57](#)
- invoker's rights clause, [13-117](#)
- invoker's rights unit
- See IR unit
- IR unit, [8-50](#)
- call stack and, [8-50](#)
 - dynamic SQL and, [8-50](#)
 - granting roles to, [8-52](#)
 - name resolution and, [8-50](#)
 - privilege checking and, [8-50](#)
 - static SQL and, [8-50](#), [8-52](#)
 - template objects for, [8-52](#)
 - See also AUTHID property
- IS [NOT] NULL operator, [2-38](#)
- isolation level of transaction, [6-57](#)
- ## J
-
- Java class method invocation, [8-53](#)
- Java method declaration, [13-23](#)
- ## K
-
- key-value pair
- See associative array
- keywords, [2-6](#)
- list of, [D-1](#)
- ## L
-
- labeled LOOP statement, [4-11](#)
- LAST collection method, [5-37](#)
- LEVEL pseudocolumn, [6-3](#)
- lexical unit, [2-4](#)
- library
- creating, [14-31](#)

library (*continued*)
 dropping, [14-82](#)
 explicitly recompiling, [14-4](#)

library arithmetic, [12-9](#)

LIKE operator, [2-40](#)

LIMIT clause, [12-37](#)

LIMIT collection method, [5-43](#)

line-continuation character, [2-10](#)

literal, [2-10](#)

local identifier, [2-21](#)

locator variable, [11-7](#)

lock mode, [6-52](#)

LOCK TABLE statement, [6-52](#)

locking
 overriding default, [6-52](#)
 result set row, [6-53](#)
 table, [6-52](#)

logical operator, [2-32](#)

logical value, [3-8](#)

LOGIN_DENIED exception, [11-11](#)

LONG data type, [3-7](#)
 in trigger, [9-42](#)

LONG RAW data type, [3-7](#)
 in trigger, [9-42](#)

LOOP statement
 exiting, [4-9](#)
 kinds of, [4-9](#)
 labeled, [4-9](#), [4-11](#)
 nested, [4-11](#)
 optimizing, [12-9](#)

LOOP UNTIL structure, [4-22](#)

M

MALFORMED_WRAP_INPUT exception, [A-8](#)

manageability, [1-3](#)

MapReduce workloads, [14-25](#), [14-76](#)

materialized view, trigger and, [14-45](#)

membership test, [2-42](#)

Method 4, [7-11](#)

method, collection
 See collection method

mixed parameter notation, [8-26](#)

mode
 lock, [6-52](#)
 subprogram parameter, [8-15](#)

multibyte character set
 as database character set, [2-1](#)
 variables for values from, [3-5](#)

multidimensional collection, [5-23](#)

multiline comment, [2-14](#)

multiple data transformations, [12-41](#)

multiset condition, [5-28](#)

mutating table, [9-42](#)

mutating-table error
 for function, [8-49](#)
 for trigger, [9-42](#)

N

name, [2-20](#)
 qualified
 See dot notation, [2-20](#)
 qualified remote, [2-20](#)
 remote, [2-20](#)
 simple, [2-20](#)
 See also identifier

name resolution, [B-1](#)
 AUTHID property and, [8-50](#)
 in static SQL, [B-6](#)
 PL/SQL and SQL differences, [B-5](#)

named cursor, [6-9](#)
 pipelined table function and, [12-47](#)
 See also explicit cursor and cursor variable

named parameter notation, [8-26](#)

national character set, [2-3](#)

native dynamic SQL, [7-2](#)
 switching to DBMS_SQL package from, [7-11](#)

native execution, compilation for, [12-70](#)

NATURAL subtype, [3-11](#)

NATURALN subtype, [3-11](#)

nested comment, [2-14](#)

nested cursor, [6-43](#)

nested IF statement, [4-3](#)
 IF THEN ELSIF form and, [4-5](#)

nested LOOP statement, [4-11](#)

nested record
 assignment example, [5-59](#)
 declaration example, [5-49](#)

nested subprogram, [8-2](#)
 declaration and definition of, [8-2](#)
 forward declaration for, [8-9](#)

nested table, [5-12](#)
 assigning null value to, [5-21](#)
 assigning set operation result to, [5-22](#)
 characteristics of, [5-2](#)
 column in view, trigger on, [9-6](#)
 comparing to NULL, [5-26](#)
 comparing two, [5-27](#)
 correlation names and, [9-28](#)
 COUNT method for, [5-42](#)
 FIRST and LAST methods for, [5-40](#)
 returned by function, [12-42](#)
 SQL multiset conditions and, [5-28](#)
 See also collection

nested transaction, [6-55](#)

NEW correlation name, [9-28](#)
 with LONG or LONG RAW column, [9-42](#)

NEXT collection method, [5-44](#)

NEXTVAL pseudocolumn, [6-4](#)
 NLS parameters
 associative array and, [5-8](#)
 character comparison and, [2-39](#)
 SQL injection and, [7-21](#)
 NO_DATA_FOUND exception, [11-11](#)
 NO_DATA_NEEDED exception, [12-51](#)
 SQLCODE for, [11-11](#)
 no-op (no operation) statement, [4-25](#)
 NOCOPY hint, [13-106](#)
 subprogram parameter aliasing and, [8-20](#)
 tuning subprogram invocation with, [12-7](#)
 nonpadded comparison semantics, [3-7](#)
 IS [NOT] NULL operator
 collections and, [5-26](#)
 NOT NULL constraint, [2-15](#)
 %TYPE attribute and, [2-19](#)
 EXTEND method and, [5-35](#)
 NOT operator, [2-32](#)
 NOT_LOGGED_ON exception, [11-11](#)
 null collection, [5-2](#)
 assigning to collection variable, [5-21](#)
 collection method and, [5-29](#)
 NULL statement
 syntax diagram, [13-122](#)
 uses for, [4-25](#)
 null string, [2-10](#)
 NULL value
 assigning to record variable, [5-64](#)
 comparing to collection
 associative array, [5-25](#)
 nested table, [5-26](#)
 varray, [5-26](#)
 comparison operator and, [2-37](#)
 concatenation operator and, [2-29](#)
 for \$\$PLSQL_UNIT inquiry directive, [2-57](#)
 for \$\$PLSQL_UNIT_OWNER inquiry
 directive, [2-57](#)
 for collection variable, [5-21](#)
 for subprogram parameter, [8-23](#)
 for unresolvable inquiry directive, [2-61](#)
 in control statement, [2-32](#)
 IN operator and, [2-42](#)
 in set, [2-42](#)
 in USING clause, [7-2](#)
 simple CASE expression and, [2-44](#)
 simple CASE statement and, [4-7](#)
 NUMBER data type family
 inefficiency of, [12-9](#)
 members of, [E-1](#)

O

obfuscating PL/SQL source text
 See wrapping PL/SQL source text

object type
 See Abstract Data Type (ADT)
 OBJECT_VALUE pseudocolumn, [9-32](#)
 OCI
 associative array and, [5-9](#)
 cursor variable and, [6-42](#)
 of RETURNING INTO clause, [12-38](#)
 OLD correlation name, [9-28](#)
 OPEN FOR statement, [13-124](#)
 recursive invocation and, [8-35](#)
 OPEN statement, [13-122](#)
 recursive invocation and, [8-35](#)
 operation, [2-30](#)
 operator
 comparison, [2-37](#)
 cursor variable and, [13-50](#)
 logical, [2-32](#)
 relational, [2-38](#)
 collection and, [5-25](#)
 operator precedence, [2-30](#)
 optimizer
 PL/SQL, [12-1](#)
 SQL, [12-47](#)
 OR operator, [2-32](#)
 ORA-*n* error
 See internally defined exception
 Oracle Call Interface (OCI)
 associative array and, [5-9](#)
 cursor variable and, [6-42](#)
 Oracle RAC environment, result caches in, [8-47](#)
 ordinary user-defined identifier, [2-7](#)
 Original Import and triggers, [9-48](#)
 OUT parameter mode, [8-15](#)
 out-bind, [12-12](#)
 outer capture, [B-7](#)
 output, [1-6](#)
 overloaded subprogram, [8-30](#)
 INLINE pragma and, [12-2](#)

P

package, [10-1](#)
 body of
 See package body, [10-6](#)
 DBMS_STANDARD, [2-20](#)
 explicitly recompiling, [14-6](#)
 features of, [10-2](#)
 granting roles to, [8-52](#)
 guidelines for writing, [10-12](#)
 initialization of, [10-7](#)
 of static constants, [2-53](#)
 private items in, [10-6](#)
 product-specific, [10-1](#)
 public items in
 See public package item, [10-3](#)

- package (*continued*)
 - reasons to use, [10-2](#)
 - SERIALLY_REUSABLE, [10-8](#)
 - specification of
 - See package specification, [10-3](#)
 - STANDARD
 - See STANDARD package, [10-18](#)
 - state of, [10-7](#)
 - supplied by Oracle, [10-1](#)
 - wrapping, [A-1](#)
 - guideline for, [A-2](#)
- package body, [10-1](#)
 - creating, [14-38](#)
 - dropping, [14-83](#)
 - initialization part of, [10-6](#)
 - assigning initial values in, [10-12](#)
 - replacing, [14-38](#)
- package specification, [10-1](#), [10-3](#)
 - creating, [14-35](#)
 - cursor variable in, [13-50](#)
 - dropping, [14-83](#)
 - replacing, [14-35](#)
 - See also public package item
- package subprogram, [8-2](#)
- parallel DML
 - bulk binding and, [12-12](#)
 - for large table, [12-67](#)
- PARALLEL_ENABLE clause, [13-126](#)
 - in CREATE FUNCTION statement, [14-25](#)
- PARALLEL_ENABLE option, [13-108](#)
 - for pipelined table function, [12-43](#)
 - for table function, [12-42](#)
- parameter
 - compilation
 - See compilation parameter, [1-11](#)
 - explicit cursor, [6-16](#)
 - initialization, [1-11](#)
 - subprogram
 - See subprogram parameter, [8-9](#)
- parameter mode, [8-15](#)
- PARENT correlation name, [9-28](#)
 - with LONG or LONG RAW column, [9-42](#)
- parentheses
 - nested, [2-30](#)
 - to control evaluation order, [2-30](#)
 - to improve readability, [2-30](#)
- pattern matching, [2-40](#)
- percent sign (%) wildcard character, [2-40](#)
- PERFORMANCE compile-time warning, [11-2](#)
- PIPE ROW statement, [12-43](#)
 - in autonomous routine, [6-60](#)
- PIPELINED Function
 - syntax diagram, [13-130](#)
- PIPELINED option, [12-42](#)
 - where to specify, [12-43](#)
- pipelined table function, [12-41](#), [12-42](#)
 - as aggregate function, [12-47](#)
 - in autonomous transaction, [13-129](#)
 - See also table function
- PL/Scope tool, [12-68](#)
- PL/SQL architecture, [1-10](#)
- PL/SQL block
 - See block
- PL/SQL engine, [1-10](#)
- PL/SQL function result cache, [8-37](#)
- PL/SQL language
 - advantages of, [1-1](#)
 - high performance of, [1-2](#)
 - high productivity with, [1-2](#)
 - lexical units of, [2-4](#)
 - limits of, [C-1](#)
 - main features of, [1-3](#)
 - manageability and, [1-3](#)
 - portability of, [1-2](#)
 - program limits of, [C-1](#)
 - scalability of, [1-3](#)
 - SQL integration in, [1-1](#)
 - syntax and semantics, [13-1](#)
- PL/SQL optimizer, [12-1](#)
- PL/SQL table
 - See associative array
- PL/SQL unit, [1-11](#)
 - stored
 - See stored PL/SQL unit, [1-11](#)
- PL/SQL Wrapper utility, [A-2](#)
- placeholder for bind variable
 - in conditional compilation directive, [2-63](#)
 - in dynamic SQL
 - EXECUTE IMMEDIATE statement and, [7-2](#)
 - repeated, [7-9](#)
 - in static SQL, [6-1](#)
 - OPEN FOR statement and, [6-33](#)
 - in trigger body, [9-28](#)
- PLS_INTEGER data type, [3-10](#)
 - tuning code and, [12-9](#)
- PLS_INTEGER static expression, [2-51](#)
- PLSQL_CCFLAGS compilation parameter, [2-60](#)
- PLSQL_OPTIMIZE_LEVEL compilation parameter, [12-1](#)
- PLSQL_WARNINGS compilation parameter
 - displaying value of
 - with ALL_PLSQL_OBJECT_SETTINGS view, [11-2](#)
 - with DBMS_WARNING subprogram, [11-4](#)
 - setting value of
 - with ALTER statements, [11-2](#)
 - with PLSQL_WARNINGS subprogram, [11-4](#)

polymorphic table function, [12-53](#)
 compilation and execution, [12-57](#)
 definition, [12-53](#)
 implementation, [12-54](#)
 invocation, [12-54](#)
 COLUMNS pseudo-operator, [12-56](#)
 optimization, [12-57](#)
 portability, [1-2](#)
 positional parameter notation, [8-26](#)
 POSITIVE subtype, [3-11](#)
 POSITIVEN subtype, [3-11](#)
 post-processed source text, [2-63](#)
 pragma, [2-12](#)
 AUTONOMOUS_TRANSACTION, [13-12](#)
 for pipelined table function, [12-43](#)
 COVERAGE, [13-45](#)
 DEPRECATE, [13-56](#)
 EXCEPTION_INIT, [13-74](#)
 INLINE, [12-2](#)
 syntax diagram, [13-115](#)
 RESTRICT_REFERENCES, [13-139](#)
 SERIALLY_REUSABLE, [13-153](#)
 UDF, [13-162](#)
 precedence, operator, [2-30](#)
 predefined constant, [3-3](#)
 predefined data type, [E-1](#)
 predefined exception, [11-11](#)
 raising explicitly, [11-17](#)
 redeclared, [11-14](#)
 predefined inquiry directive, [2-57](#)
 predefined subtype, [E-1](#)
 preprocessor control token, [2-56](#)
 PRIOR collection method, [5-44](#)
 privilege checking and AUTHID property, [8-50](#)
 procedure, [8-1](#)
 declaration syntax, [13-133](#)
 invoking, [8-2](#)
 structure of, [8-5](#)
 See also subprogram
 procedure specification, [13-133](#)
 product-specific package, [10-1](#)
 profiling and tracing programs, [12-68](#)
 program limits, [C-1](#)
 PROGRAM_ERROR exception, [11-11](#)
 pseudocolumn, [6-3](#)
 OBJECT_VALUE, [9-32](#)
 pseudoinstruction
 See pragma
 pseudorecord, [9-28](#)
 See also correlation name
 public package item, [10-3](#)
 appropriate, [10-4](#)
 collection type as, [5-46](#)
 cursor variable as, [13-50](#)
 declaring, [10-3](#)

public package item (*continued*)
 RECORD type as, [5-49](#)
 referencing, [10-3](#)
 remote variable, [10-4](#)
 scope of, [10-3](#)
 visibility of, [10-3](#)
 publishing events, [9-49](#)
 purity rules for subprograms, [8-49](#)

Q

qualified expression, [5-17](#)
 qualified name
 See dot notation
 qualified remote name, [2-20](#)
 query, [6-1](#)
 implicitly returning results of, [7-12](#)
 invoking function in, [12-6](#)
 processing result set of, [6-24](#)
 multiple-row dynamic query, [7-8](#)
 See also SELECT INTO statement
 quotation mark, single or double, [2-1](#)
 quoted user-defined identifier, [2-8](#)

R

RAISE statement, [11-16](#)
 syntax diagram, [13-136](#)
 RAISE_APPLICATION_ERROR procedure,
 [11-18](#)
 raising exception explicitly, [11-16](#)
 range test, [2-42](#)
 read-only transaction, [6-51](#)
 read-write transaction, [6-51](#)
 recompiling stored PL/SQL unit, [14-1](#)
 record, [5-1](#)
 as public package item, [5-49](#)
 assigning value to, [5-58](#)
 comparing one to another, [5-65](#)
 creating, [5-48](#)
 syntax diagram, [13-137](#)
 declaring constant, [5-48](#)
 nested
 See nested record, [5-49](#)
 representing row, [5-53](#)
 types of, [5-49](#)
 recursive subprogram, [8-35](#)
 result-cached, [8-42](#)
 recursive trigger, [9-39](#)
 REF CURSOR
 See cursor variable
 REF CURSOR type, [6-32](#)
 relational operator, [2-38](#)
 collection and, [5-25](#)
 RELEASE constant, [2-61](#)

remote exception handling
 subprograms and, [11-19](#)
 triggers and, [9-38](#)

remote name, [2-20](#)

remote public package variable, [10-4](#)

remote subprogram
 exceptions in, [11-19](#)
 invoked by trigger, [9-36](#)
 with composite parameter, [5-1](#)

REPEAT UNTIL structure, [4-22](#)

replacing stored PL/SQL unit, [14-1](#)

reraising exception, [11-17](#)

reserved preprocessor control token, [2-56](#)

reserved words
 information about, [2-6](#)
 list of, [D-1](#)

RESTRICT_REFERENCES pragma, [13-139](#)

result cache, [8-37](#)

RESULT_CACHE clause, [8-38](#), [13-145](#)

RESULT_CACHE option for function, [13-108](#),
[14-25](#)

RETURN clause of function, [8-5](#)

RETURN INTO clause
 See RETURNING INTO clause

RETURN statement, [8-6](#)

RETURN_RESULT procedure, [7-12](#)

RETURNING INTO clause, [13-142](#)
 BULK COLLECT clause of, [12-38](#)
 FORALL statement and, [12-39](#)

returning query results implicitly, [7-12](#)

REUSE SETTINGS clause, [1-11](#)

ROLLBACK statement, [6-47](#)
 FOR UPDATE cursor and, [6-53](#)
 implicit, [6-50](#)
 in autonomous transaction, [6-59](#)
 transparent, [9-39](#)

row-level trigger, [9-4](#)

rowid, [3-7](#)

ROWID data type, [3-7](#)

ROWID pseudocolumn, [6-3](#)
 instead of CURRENT OF clause, [6-53](#)

ROWNUM pseudocolumn
 bulk SELECT operation and, [12-33](#)
 single-row result set and, [6-26](#)

ROWTYPE_MISMATCH exception
 error code for, [11-11](#)
 example of, [11-11](#)

runtime error
 See exception

S

same-scope capture, [B-7](#)

SAMPLE clause, [12-33](#)

SAVEPOINT statement, [6-48](#)
 in autonomous transaction, [6-60](#)

scalability
 SERIALLY_REUSABLE packages and, [10-8](#)
 subprograms and, [1-3](#)

scalar data type, [3-1](#)

scalar variable
 assigning value to, [2-25](#)
 declaration, [2-16](#)
 syntax diagram, [13-149](#)
 initial value of, [2-17](#)

schema object
 See stored PL/SQL unit

SCHEMA trigger, [9-34](#)

scope of identifier, [2-21](#)

searched CASE expression, [2-46](#)

searched CASE statement, [4-8](#)
 syntax diagram, [13-26](#)

security mechanism
 against SQL injection, [7-17](#)
 PL/SQL source text wrapping
 benefit of, [A-1](#)
 limitations of, [A-2](#)
 trigger as, [9-3](#)

SELECT FOR UPDATE statement, [6-53](#)

SELECT INTO statement, [6-1](#)
 assigning values with
 to record variable, [5-61](#)
 to scalar variables, [2-26](#)
 avoiding inner capture in, [B-8](#)
 query result set processing with, [6-25](#)
 SQL%NOTFOUND attribute and, [6-8](#)
 SQL%ROWCOUNT attribute and, [6-8](#)
 syntax diagram, [13-150](#)
 with BULK COLLECT clause, [12-26](#)
 See also query

selection directive, [2-56](#)

selector
 in simple CASE expression, [2-44](#)
 in simple CASE statement, [4-7](#)

SELF_IS_NULL exception, [11-11](#)

sequence, [6-4](#)

sequential control statement, [4-22](#)

SERIALLY_REUSABLE package, [10-8](#)

SERIALLY_REUSABLE pragma, [13-153](#)

session cursor, [6-5](#)

set data structure, [5-2](#)

set membership test, [2-42](#)

SET TRANSACTION statement, [6-51](#)

SEVERE compile-time warning, [11-2](#)

SHARING clause
 in CREATE FUNCTION statement, [14-25](#)
 in CREATE LIBRARY statement, [14-31](#)
 in CREATE PACKAGE statement, [14-35](#)
 in CREATE PROCEDURE statement, [14-42](#)

- SHARING clause (*continued*)
 - in CREATE TRIGGER statement, [14-45](#)
 - in CREATE TYPE statement, [14-65](#)
 - sharing_clause syntax diagram, [13-153](#)
- short-circuit evaluation
 - how it works, [2-37](#)
 - tuning code and, [12-12](#)
- side effects of subprogram, [8-37](#)
- SIGNTYPE subtype, [3-11](#)
- simple CASE expression, [2-44](#)
- simple CASE statement, [4-7](#)
 - IF THEN ELSIF statement and, [4-5](#)
 - syntax diagram, [13-26](#)
- simple DML trigger, [9-4](#)
- simple name, [2-20](#)
- SIMPLE_DOUBLE subtype, [3-3](#)
 - tuning code and, [12-9](#)
- SIMPLE_FLOAT subtype, [3-3](#)
 - tuning code and, [12-9](#)
- SIMPLE_INTEGER subtype, [3-12](#)
 - tuning code and, [12-9](#)
- single quotation mark ('), [2-1](#)
- single-line comment, [2-13](#)
- sort ordering, [13-54](#)
- sparse collection, [5-2](#)
 - FORALL statement for, [12-16](#)
 - SQL%BULK_EXCEPTIONS and, [12-23](#)
 - traversing, [5-44](#)
- specification
 - cursor, [13-83](#)
 - function, [13-108](#)
 - package
 - See package specification, [10-1](#)
 - procedure, [13-133](#)
- SQL
 - bulk, [12-12](#)
 - in compound DML trigger, [9-12](#)
 - dynamic
 - See dynamic SQL, [7-1](#)
 - static
 - See static SQL, [6-1](#)
- SQL cursor
 - See implicit cursor
- SQL data type, [3-2](#)
- SQL function, [12-11](#)
 - in PL/SQL expression, [2-47](#)
 - tuning and, [12-11](#)
- SQL injection, [7-17](#)
- SQL integration in PL/SQL, [1-1](#)
- SQL multiset condition, [5-28](#)
- SQL MULTISET operator, [5-22](#)
- SQL optimizer, [12-47](#)
- SQL statement, [1-4](#)
 - for stored PL/SQL unit, [14-1](#)
 - in trigger, [9-1](#)
- SQL statement (*continued*)
 - invoking collection method in, [5-29](#)
 - invoking PL/SQL function in, [8-49](#)
 - tuning, [12-5](#)
 - See also anonymous block
- SQL_MACRO, [13-158](#)
- SQL_MACRO clause
 - in CREATE FUNCTION statement, [14-25](#)
- SQL*Loader and triggers, [9-48](#)
- SQL%BULK_EXCEPTIONS cursor attribute, [12-21](#)
- SQL%BULK_ROWCOUNT cursor attribute, [12-24](#)
- SQL%FOUND cursor attribute, [6-7](#)
- SQL%NOTFOUND cursor attribute, [6-8](#)
- SQL%ROWCOUNT cursor attribute, [6-8](#)
- SQLCODE function, [13-155](#)
- SQLERRM function, [13-156](#)
 - SQL%BULK_EXCEPTIONS and, [12-21](#)
- standalone subprogram, [8-2](#)
 - function
 - creating, [14-25](#)
 - dropping, [14-80](#)
 - explicitly recompiling, [14-2](#)
 - replacing, [14-25](#)
 - procedure
 - creating, [14-42](#)
 - dropping, [14-85](#)
 - explicitly recompiling, [14-8](#)
 - replacing, [14-42](#)
- STANDARD package
 - data type defined in
 - See predefined data type, [E-1](#)
 - exception defined in
 - See predefined exception, [11-11](#)
 - how it defines PL/SQL environment, [10-18](#)
 - listing identifiers defined in, [2-6](#)
 - referencing item defined in, [2-20](#)
- statement injection, [7-20](#)
- statement modification, [7-18](#)
- statement-level trigger, [9-4](#)
- static constant, [2-53](#)
 - in DBMS_DB_VERSION package, [2-61](#)
- static expression, [2-48](#)
- static SQL, [6-1](#)
 - AUTHID property and, [8-50](#)
 - name resolution in, [B-6](#)
 - PL/SQL identifier in, [6-1](#)
 - placeholder for bind variable in, [6-1](#)
 - OPEN FOR statement and, [6-33](#)
- STORAGE_ERROR exception, [11-11](#)
 - recursive invocation and, [8-35](#)
- store table, [5-16](#)
- stored PL/SQL unit, [1-11](#), [14-1](#)
 - creating, [14-1](#)

stored PL/SQL unit (*continued*)
 recompiling, [14-1](#)
 replacing, [14-1](#)
 wrapping, [A-1](#)

stored subprogram, [8-2](#)
 unhandled exception in, [11-27](#)
 wrapping, [A-1](#)

string, [2-10](#)
 null, [2-10](#)
 zero-length, [2-10](#)
 See also character literal

STRING subtype, [3-5](#)

strong REF CURSOR type
 creating, [6-32](#)
 FETCH statement and, [6-34](#)

subprogram, [8-1](#)
 inlining, [12-2](#)
 invoked by trigger, [9-36](#)
 remote
 See remote subprogram, [5-1](#)
 unhandled exception in, [11-27](#)

subprogram invocation
 optimization of, [12-2](#)
 resolution of, [8-28](#)
 syntax of, [8-2](#)
 tuning, [12-7](#)

subprogram parameter, [8-9](#)
 collection as, [5-29](#)
 composite variable as, [5-1](#)
 CURSOR expression as actual, [6-43](#)
 cursor variable as, [6-39](#)
 optional, [8-23](#)
 query result as, [6-39](#)
 required, [8-23](#)

subprogram property, [8-3](#)

subquery
 correlated, [6-29](#)
 result set processing with, [6-29](#)

SUBSCRIPT_BEYOND_COUNT exception, [11-11](#)

SUBSCRIPT_OUTSIDE_LIMIT exception, [11-11](#)

subtype, [3-1](#)
 constrained, [3-15](#)
 subprogram parameter and, [8-12](#)
 of BINARY_DOUBLE data type, [3-3](#)
 of BINARY_FLOAT data type, [3-3](#)
 of PLS_INTEGER data type, [3-11](#)
 predefined, [E-1](#)
 unconstrained, [3-14](#)
 user-defined, [3-14](#)
 See also data type

synonym, [2-20](#)

SYS_INVALID_ROWID exception, [11-11](#)

SYS_REFCURSOR type, [6-32](#)

system trigger, [9-34](#)

T

table
 hash, [5-2](#)
 index-by
 See associative array, [5-4](#)
 mutating, [9-42](#)
 nested, [5-12](#)
 characteristics of, [5-2](#)
 parallel DML for large, [12-67](#)
 PL/SQL
 See associative array, [5-4](#)
 store, [5-16](#)
 unordered, [5-2](#)
 updating large in parallel, [12-67](#)

table alias
 for avoiding inner capture, [B-8](#)
 for row expression, [B-10](#)
 for table element attribute or method, [B-9](#)

table function, [12-41](#), [12-42](#)
 pipelined
 See pipelined table function, [12-41](#)
 weak cursor variable argument to, [6-32](#)

TABLE operator, [6-38](#)

TCL statement, [6-1](#)
 in subprogram invoked by trigger, [9-36](#)
 in trigger, [6-60](#)

template object, [8-52](#)

TIMEOUT_ON_RESOURCE exception, [11-11](#)

timing point
 of DML trigger
 compound, [9-11](#)
 simple, [9-4](#)
 of system trigger, [9-34](#)
 trigger firing order and, [9-46](#)

TO_NUMBER function, [7-16](#)

TO_REFCURSOR function, [7-15](#)

TOO_MANY_ROWS exception, [11-11](#)

trace file, [11-1](#)

tracing and profiling programs, [12-68](#)

transaction
 autonomous, [6-55](#)
 pipelined table function in, [13-129](#)
 context of, [6-57](#)
 ending
 with COMMIT statement, [6-45](#)
 with ROLLBACK statement, [6-47](#)
 isolation level of, [6-57](#)
 nested, [6-55](#)
 read-only, [6-51](#)
 read-write, [6-51](#)
 retrying after handling exception, [11-30](#)
 SQL%ROWCOUNT cursor attribute and, [6-8](#)
 visibility of, [6-57](#)

Transaction Control Language

See TCL statement
 TRANSACTIONS initialization parameter, [6-60](#)
 tri-state logic, [2-32](#)
 trigger, [9-1](#)
 as security mechanism, [9-3](#)
 AUTHID property and, [8-50](#)
 autonomous, [6-60](#)
 cascading, [9-46](#)
 DDL statement in, [6-60](#)
 hiding implementation details of, [A-2](#)
 materialized view and, [14-45](#)
 recursive, [9-39](#)
 TCL statement in, [6-60](#)
 TRIM collection method, [5-33](#)
 tuning PL/SQL code, [12-1](#)
 type
 See data type
 type-compatible data type
 for collection variables, [5-20](#)
 for scalar variables, [2-25](#)
 typemark, [5-17](#)

U

UDF pragma, [13-162](#)
 unconstrained subtype, [3-14](#)
 underscore (`_`) wildcard character, [2-40](#)
 unhandled exception, [11-27](#)
 in FORALL statement, [12-19](#)
 unordered table, [5-2](#)
 UPDATE statement, [13-162](#)
 BEFORE statement trigger and, [9-39](#)
 PL/SQL extensions to, [13-162](#)
 with values in record, [5-66](#)
 restrictions on, [5-67](#)
 See also DML statement
 UPDATING conditional predicate, [9-5](#)
 UROWID data type, [3-7](#)
 user-defined exception, [11-14](#)
 giving error code to, [11-18](#)
 raising
 with RAISE statement, [11-16](#)
 with RAISE_APPLICATION_ERROR
 procedure, [11-18](#)
 user-defined identifier, [2-7](#)
 collecting data about, [12-68](#)
 user-defined subtype, [3-14](#)
 user-defined type
 See Abstract Data Type (ADT)
 USING_NLS_COMP, [13-54](#)
 utlrlp.sql script, [12-72](#)

V

V\$RESERVED_WORDS view, [D-1](#)

validation check for avoiding SQL injection, [7-25](#)
 VALUE_ERROR exception, [11-11](#)
 VARCHAR subtype, [3-5](#)
 VARCHAR2 data type, [3-4](#)
 VARCHAR2 static expression, [2-53](#)
 variable
 binding of, [12-12](#)
 BOOLEAN, [2-28](#)
 collection
 See collection, [5-1](#)
 composite, [5-1](#)
 cursor
 See cursor variable, [6-30](#)
 host
 cursor variable as, [6-42](#)
 packages and, [10-2](#)
 in cursor variable query, [6-36](#)
 in explicit cursor query, [6-14](#)
 locator, [11-7](#)
 record
 See record, [5-1](#)
 remote public package, [10-4](#)
 scalar
 See scalar variable, [2-16](#)
 with undefined value, [6-1](#)
 variable-size array
 See varray
 variadic pseudo-operator, [12-56](#)
 varray, [5-10](#)
 assigning null value to, [5-21](#)
 characteristics of, [5-2](#)
 comparing to NULL, [5-26](#)
 COUNT method for, [5-41](#)
 FIRST and LAST methods for, [5-38](#)
 returned by function, [12-42](#)
 See also collection
 VERSION constant, [2-61](#)
 view
 AUTHID property and, [8-50](#)
 INSTEAD OF trigger and, [14-45](#)
 materialized, trigger and, [14-45](#)
 virtual column, [6-15](#)
 %ROWTYPE attribute and, [5-56](#)
 explicit cursors and, [6-15](#)
 visibility
 of identifier, [2-21](#)
 of transaction, [6-57](#)

W

warning, compile-time, [11-2](#)
 weak REF CURSOR type
 creating, [6-32](#)
 FETCH statement and, [6-34](#)

WHILE LOOP statement, [4-22](#)
 syntax diagram, [13-164](#)

white list

 See ACCESSIBLE BY clause

whitespace character

 between lexical units, [2-15](#)

 in character literal, [2-10](#)

 in database character set, [2-1](#)

wildcard character, [2-40](#)

WRAP function, [A-8](#)

wrap utility

 See PL/SQL Wrapper utility

wrapping PL/SQL source text, [A-1](#)

 inquiry directives and, [2-61](#)

Z

ZERO_DIVIDE exception, [11-11](#)

zero-length string, [2-10](#)